

**AMVECO**  
TOROIDAL POWER PRODUCTS

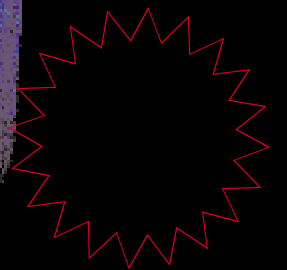

*On this page you can learn about the advantages and benefits of using our toroidal transformers. First we would like to list four features that are unique to AMVECO and its line of toroidal transformers. Four features that you will surely benefit from.*

- *AMVECO is an ISO 9001 registered company*
- *AMVECO's transformers use only flameretardent material (UL 94-V2)*
- *AMVECO offers lifetime warranty for its products*
- *AMVECO's transformers are recognized to several UL standards and certified by CSA as well as TUV for medical applications.*

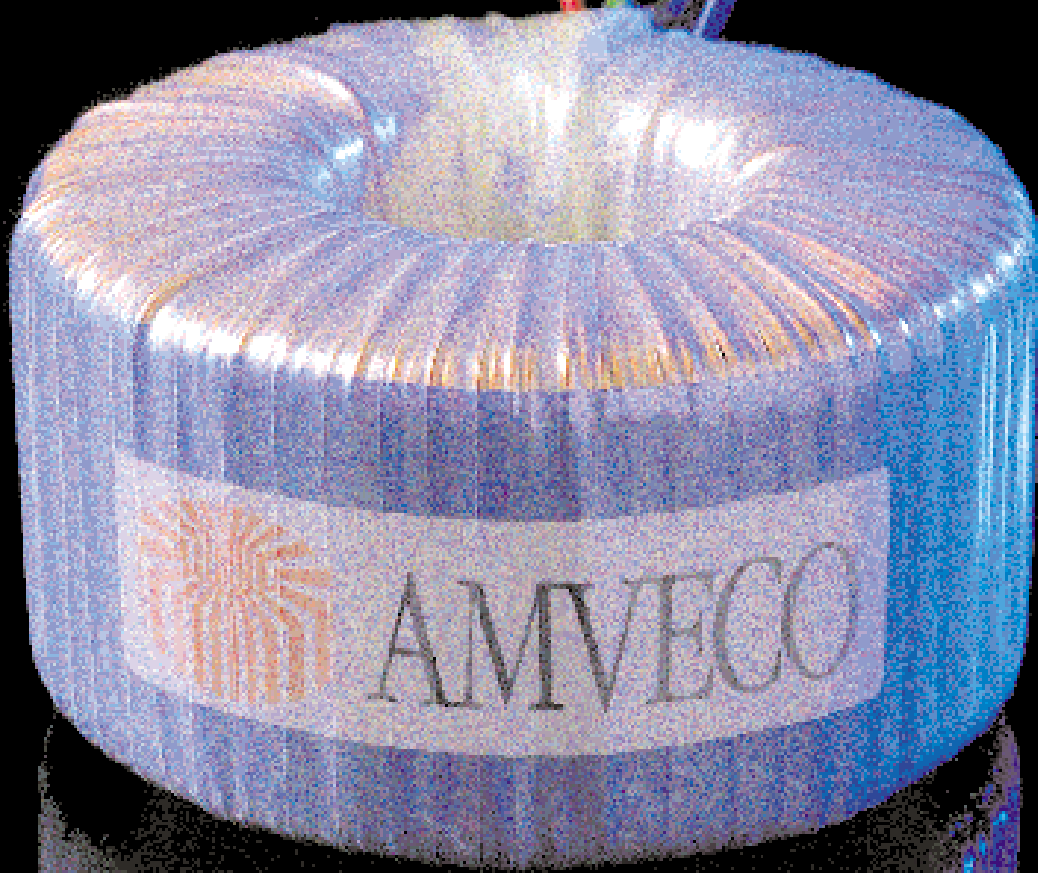

## ***High Performance Products For Your High Performance Applications.***



### **SMALL SIZE**

Most toroids are smaller than their E-I transformer counterparts. Electrical and mechanical designers appreciate a toroid's compact dimensions. They are particularly well suited where low height is a consideration.



### **LOW STRAY MAGNETIC FIELD**

Toroids have no airgaps: primaries and secondaries are wound uniformly around the entire core. As a result, toroids emit very low radiated magnetic fields. This makes the toroid ideal for applications involving high sensitivity circuitry.



### **LOW MECHANICAL HUM**

The core of a toroid is formed from a single strip of grain-oriented electrical grade silicon steel tightly wound in the form of a clock spring with the ends spot-welded in place. The copper wire is wound over polyester film, forming a silent, stable unit without the use of environmentally unfriendly glues or varnishes.



### **FLEXIBLE DIMENSIONS**

Compounding the benefits of low weight and small size is the flexibility to vary dimensions. Because AMVECO is not tied down to core caps or lamination sizes, the height and diameter of our toroids may be economically varied to accommodate equipment design requirements.



### **LOW WEIGHT**

Because they are more efficient, toroids can be up to 50% lighter, (depending on power rating), than conventional laminated transformers. Low weight simplifies end product design by reducing mounting hardware and supporting enclosure requirements.



### **LOW NO-LOAD LOSSES**

Compared to conventional E-I transformers, toroids exhibit extremely low no-load losses. In applications where a circuit is in a "stand-by" mode for long periods, the potential cost reduction for power can be significant, sometimes 80-90% lower.



### **HIGH EFFICIENCY**

Due to its unique construction, toroids are typically between 15 and 30% more efficient than the conventional type. As a rule; the larger the transformer - the more efficient it becomes.



### **LOW OPERATING TEMPERATURE**

Since most of the losses in a toroid are in the copperwire, the toroid cools off quicker than the conventional E-I type with more iron. At half the load, the toroid's temperature rise is only about 30% of what it is at full load.



### **EASY TO MOUNT**

A single center screw easily and quickly mounts the toroid, avoiding costly mechanical design and practical problems associated with conventional E-I-laminated transformers..., and three screws are eliminated at assembly!



# TABLE OF CONTENTS

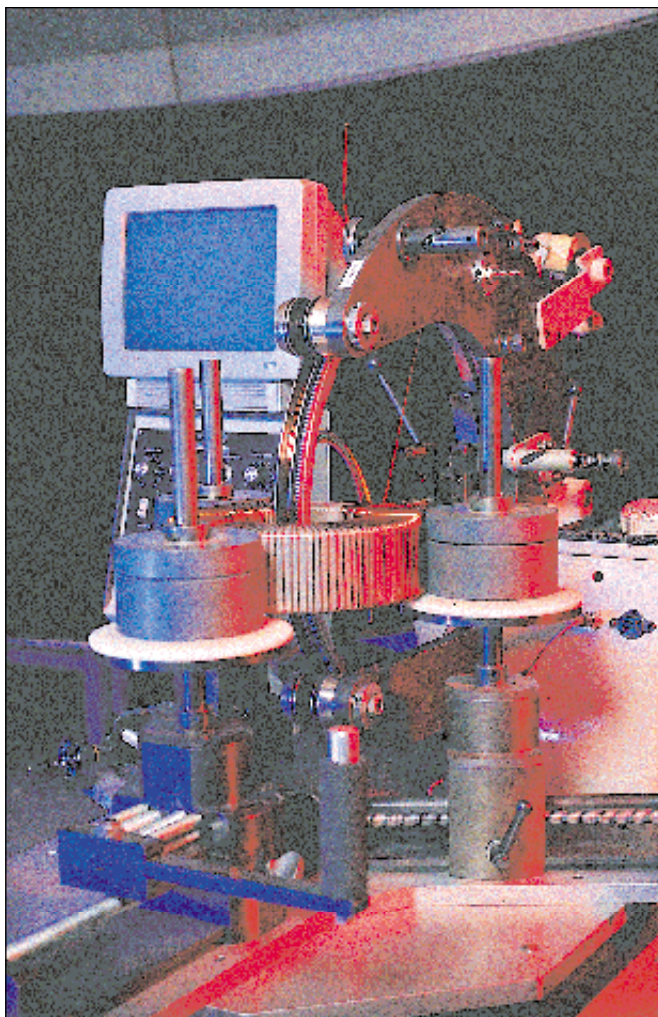

Features, Advantages and Benefits of Toroidal Power Transformers	1
Serving A Broad Range Of Industries	3
Value Added Assembly Service	3
Engineering Support	4
Interactive Website Design Service	4
Documented Reliability (ISO 9001 And Safety Standards)	5-6
AMVECO Construction Data	6
Technical Data And Application Notes	7-14
Reference Guide For Size And Losses	11
Customer Specification Sheet	12
Toroidal Mounting Methods	13-14
Considerations When Using Toroidal Power Transformers	15
Standard Design Transformers For 117V/60Hz Applications	16
Standard Design Transformers For 2x117V/50-60Hz Applications	17
Standard Design Medical Grade High Isolation Transformers	18
Custom Designed Auto-Transformers And Three-Phase Transformers	19
Current Sensing Transformers	20
Low Profile PC Mount Transformers	21
Low Profile Miniature Transformers	23
AMVECO Standard Series Inductors	25
Copy of AMVECO's ISO 9001 Certificate	26

## THE SUPERIOR/COST-EFFECTIVE TOROID

AMVECO's state-of-the-art manufacturing processes have made the use of toroids cost-effective across a broad spectrum of applications.

Toroids are routinely replacing laminated frame types in the most demanding industry applications, including: medical, telecommunications, instrumentation, test equipment, lighting and signs, process control, office and computer peripherals, audio and broadcast, as well as many others.

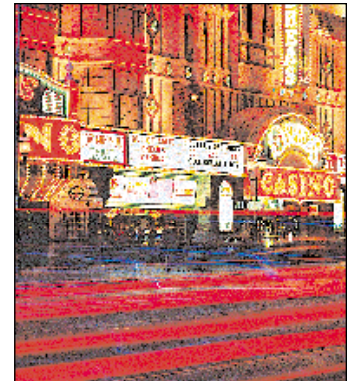
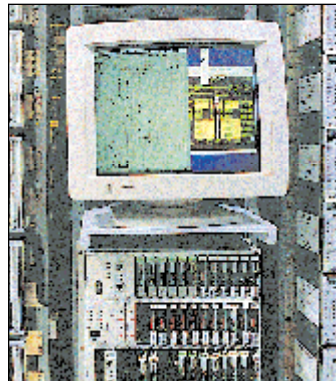
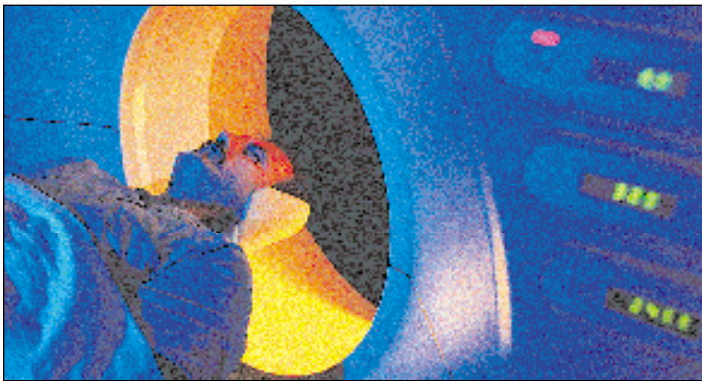

## HIGHER LEVEL ASSEMBLY

AMVECO's higher level assembly services deliver products one step closer to production. This approach can save you time and money while AMVECO's in-house tooling and testing capabilities ensure prompt delivery of high quality products ready for your final assembly.

## COMPLIMENTARY PRODUCTS

AMVECO also designs and produces standard and custom inductors, current transformers and auto transformers. All custom components are designed and manufactured to meet customer specifications and are also subjected to the same demanding manufacturing standards used in the production of our toroidal transformers. These complimentary products have been developed, and will continue to be developed, in response to your needs.



### WE ARE HERE TO SERVE YOU

Our engineers want to be part of your power supply design group. We'll show you how you can optimize your product's appearance and performance and reduce total cost.

Since most of our products are custom designed, our work begins with a customer inquiry. Together with a customer's engineers, we determine the AC line, AC or DC load requirements and other user-specific conditions. With state-of-the-art proprietary CAD programs, our engineers quickly generate preliminary designs. Often in a matter of hours, if needed.

Our tested and proven in-house software programs enable us to simulate optimum performance characteristics from your data. All of our design proposals are accompanied by a price quotation. You can then order a prototype for your evaluation, or select from our extensive inventory of standard toroids. You incur no expense until you place an order.

AMVECO can respond quickly and effectively to meet your needs because we have experienced people to assist you at every step, from the factory to the field. Expert application and product engineers can work with you from initial development through final delivery. Our knowledgeable customer service personnel utilize fully computerized processing systems for prompt, reliable service. Our representative organizations are strategically located to meet your needs nationwide.

### WEB SITE DESIGN SERVICE

To evaluate the feasibility of toroidal power transformers for specific applications, AMVECO has established an interactive web site. You need only type in user-specific transformer modeling data. The interactive program will respond with specific toroid possibilities and prompt you on how to obtain your AMVECO transformer. Our engineers will be glad to validate your design.



## SAFETY STANDARDS

AMVECO proudly holds Certificates from both North American and International Safety Standard Testing Laboratories in addition to having its factory certified to ISO 9001.

Family Approvals (Recognitions) which eliminate the need to send new designs for destructive testing.

- *UL 506 General Purpose Transformers (File # E 122978)*
- *UL 1411, Audio, Radio and Television Products (File # E 115143)*
- *UL 1950 Information Technology Equipment, Electrical Business Equipment (File # E 138299)*
- *UL 544/UL 2601 Medical and Dental Equipment (File # E 138299)*
- *UL 1446, Class B, Class F and Class H Insulation Systems (File # E 123069)*
- *CSA 22.2 No. 66-1988 Specialty Transformers (File # LR 86989)*
- *CSA 22.2 No. 601.1 M90 Medical Standard for Canada (File # E 138299)*
- *IEC 601.1 (Medical Standard for International Installations)*
- *EN 60601 Medical Standard for European Installations*
- *EN 60742/EN 61558 European Safety Standard for General Purpose Transformers*

AMVECO maintains an active policy to invest in family approvals of different domestic and international safety standards in direct response to market needs and to better serve its customer base.

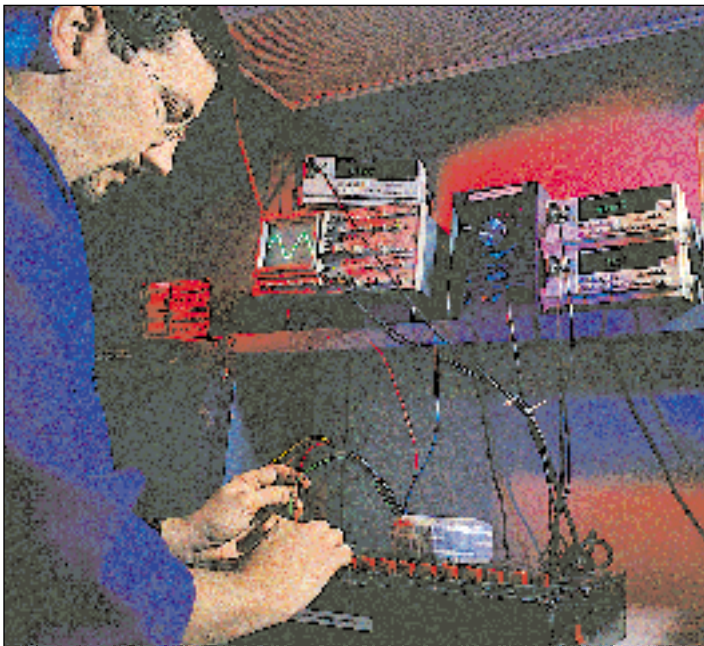

## EXPERT CERTIFICATION GUIDANCE

AMVECO can also provide test data and construction documentation required by regulatory agencies. The major agencies throughout the world have already tested our standard lines and certification for most toroid applications is on hand, including UL, CSA, TUV and CE marking is an available option.

## ISO 9001 CERTIFIED QUALITY SYSTEM

With ISO 9001 Certification as a cornerstone, since 1992, AMVECO's quality policy represents a never-ending process that involves the commitment of every employee. This commitment is proven every day, at every step in the manufacturing process through delivery of our products to you.



## UNMATCHED QUALITY/UNPARALLELED SERVICE

Power system design engineers have come to recognize AMVECO as the leading manufacturer of custom toroidal power transformers and inductors.

Over the years since 1982, we have built a reputation for excellence by focusing on design engineering state-of-the-art production capabilities and customer support services. Our quality management system has been ISO 9001 certified since 1992.

When you select AMVECO for your power transformer needs you acquire a team of experienced professionals that offer assistance from design to delivery and beyond.

One simple fact verifies our quality claims: our customers stay with us year after year and continue to trust us with their new product needs.

*In addition to Class A insulation system, Amveco offers Class B (130 °C), Class E (120 °C), Class F (155 °C) and Class H (180 °C).*

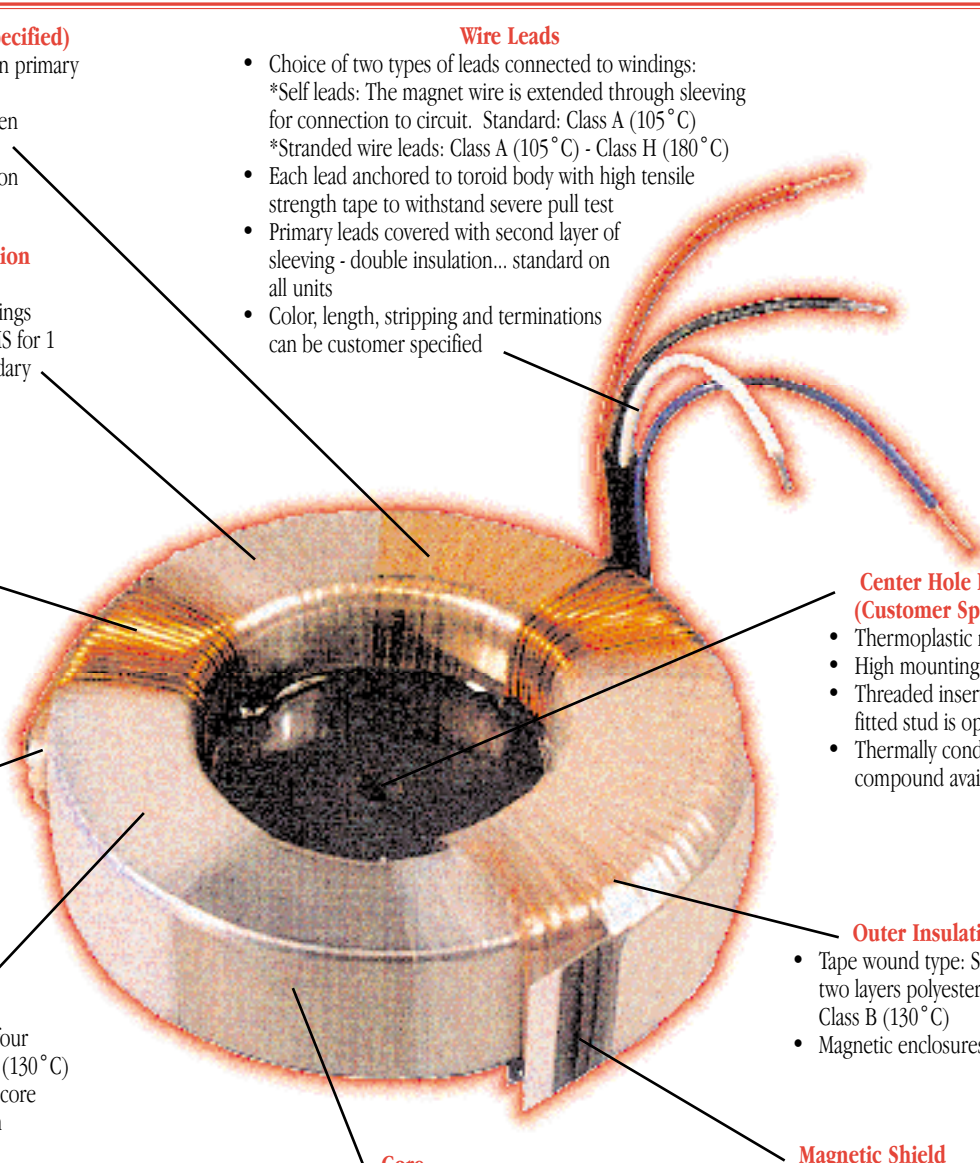

**Electrostatic Shield (Customer Specified)**

- Reduces capacitive coupling between primary and secondary windings
- Copper foil (2 mil) laminated between polyester film and tape
- Tightly wound over primary insulation

**Wire Leads**

- Choice of two types of leads connected to windings:
  - \*Self leads: The magnet wire is extended through sleeving for connection to circuit. Standard: Class A (105 °C)
  - \*Stranded wire leads: Class A (105 °C) - Class H (180 °C)
- Each lead anchored to toroid body with high tensile strength tape to withstand severe pull test
- Primary leads covered with second layer of sleeving - double insulation... standard on all units
- Color, length, stripping and terminations can be customer specified

**Primary to Secondary Insulation**

- Polyester film-Class B (130 °C)
- Four layers minimum between windings
- Meets test requirement of 4000V RMS for 1 minute between primary and secondary

**Windings**

- Base coat of Polyester. Heavy topcoat of amide imide (200 °C)
- Wound uniformly over entire core
- Better heat dissipation
- Windings configured for minimum flux leakage
- Low voltage maintained between adjacent turns

**Center Hole Potting (Customer Specified)**

- Thermoplastic material
- High mounting precision
- Threaded insert or press fitted stud is optional
- Thermally conductive compound available

**Thermal Protection (Customer Specified)**

- Usually in primary circuit
- Normally closed-auto reset opens at high temperature
- One-shot fuse also available
- UL, CSA, VDE listed components

**Outer Insulation**

- Tape wound type: Standard two layers polyester film Class B (130 °C)
- Magnetic enclosures optional

**Core Insulation**

- All cores: 100% surface coverage of four layers of 2 mil polyester film Class B (130 °C)
- Protects, insulates and cushions the core from windings and reduces vibration

**Magnetic Shield (Customer Specified)**

- Multiple layers of grain oriented silicon steel tightly wound around the toroid's circumference
- Fixed in place by outer insulation

**Core**

- Cores are manufactured and annealed in-house, under controlled conditions
- Continuous tightly wound grain oriented silicon steel... no airgaps, no mechanical noise
- Lathed radial corners... compact design, most efficient use of materials
- No core caps necessary

AMVECO's unique method to protect the wire from the sharp corners of the core during the winding operation permits unlimited choice of core size to best meet the customer's available space. Other methods include use of plastic end caps or dipping the core in epoxy. Amveco can offer these methods too, if preferred by the customer.

*The first toroid patent dates back to 1884. However, it's only during the past thirty years, as AMVECO and its predecessors developed practical manufacturing techniques, that large numbers of toroids have been applied in wide varieties of electrical and electronic products. The usage of toroids has grown rapidly because of the many features that permit new and innovative product designs. The following is a discussion of various aspects of toroidal transformer technology that will be useful to design engineers contemplating their application in new or existing equipment.*

## CUSTOM DESIGNS FOR OEM APPLICATIONS

Unlike their E-I counterparts, toroids lend themselves to custom applications because toroidal designs don't require the use of special costly tools, such as stamping dies (required for special lamination forms).

Upwards of 95% of Amveco's volume is consumed by custom products.

## SMALL SIZE THROUGH REDUCED CORE AND COPPER LOSSES

From Faraday's equation for induced voltage in a transformer winding, we derive the following practical equation:

- $E_{rms} = 4.44 \times f \times N \times B \times A \times 10^{-8}$
- $E_{rms}$  = Induced voltage in winding
- $f$  = Frequency (Hz)
- $N$  = Winding turns
- $B$  = Flux density
- $A$  = Core cross section ( $cm^2$ )

Increasing the working flux density will permit a lower number of turns and/or a smaller cross sectional core area. Experience has shown that working flux densities of 16k to 18k Gauss can be used in toroids.

Working flux densities of 12k to 14k Gauss are the practical limits for typical laminated cores with airgaps. Thus, selecting a toroid may directly reduce core material (weight) or winding turns (copper losses).

## FLEXIBLE DIMENSIONS

As long as the cross sectional area of the toroidal core is held constant, the height and diameter may be varied to meet the designer's requirement. The functional optimum diameter-to-height ratio is 2:1. For modern equipment design emphasizing a low profile, a 3:1 ratio, wider diameter and lower height may be more suitable. In cases where a smaller "footprint" is desired, a 1.5:1 ratio should be considered (narrower diameter, higher profile).

The only restrictions are those of the mechanical considerations of insulation and winding machinery. A minimum center hole must be maintained in order to permit the insertion of the winding machine shuttle into the center hole of the core.

## REDUCED SIZE REDUCTION THROUGH DUTY CYCLE

A significant reduction in transformer size and weight may be realized in many cases where the transformer is loaded intermittently. In such cases, the load is energized for a small portion of the period. If the loaded period is much shorter than the overall thermal time constant of the transformer, the following equation applies:

**Duty Cycle Information**

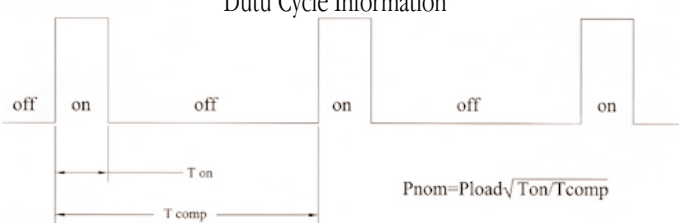

$P_{nom} = P_{load} \sqrt{T_{on} / T_{comp}}$

$P_{nom}$  = Nominal transformer power rating  
 $P_{load}$  = Actual power in load  
 $T_{on}$  = Load on time  
 $T_{comp}$  = Complete cycle time ( $T_{on} + T_{off}$ )

*Example: 750 VA load that is only utilized 15 seconds each minute.*

$P_{nom} = 750 \sqrt{15/60}$   
 $P_{nom} = 750 \sqrt{.25}$   
 $P_{nom} = 750 \times .5$   
 $P_{nom} = 375VA$



## TEMPERATURE RISE CONSIDERATIONS

Total losses for the transformer, including winding losses and core loss at a given flux level, may be calculated from design data and data furnished by steel suppliers.

At AMVECO, our toroids are ordinarily designed to render a 60°C to 65°C temperature rise. The graph below illustrates the rise in transformer temperature as the actual power approaches and then exceeds the transformer's nominal power rating. Careful consideration must be given to the expected load conditions.

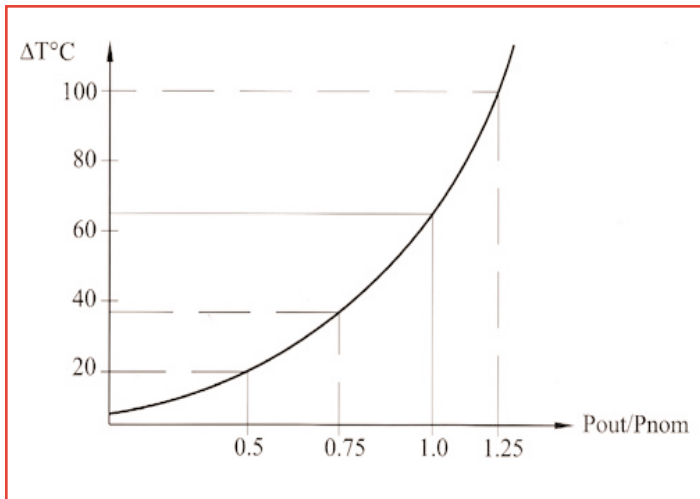

## STRAY FIELD DATA

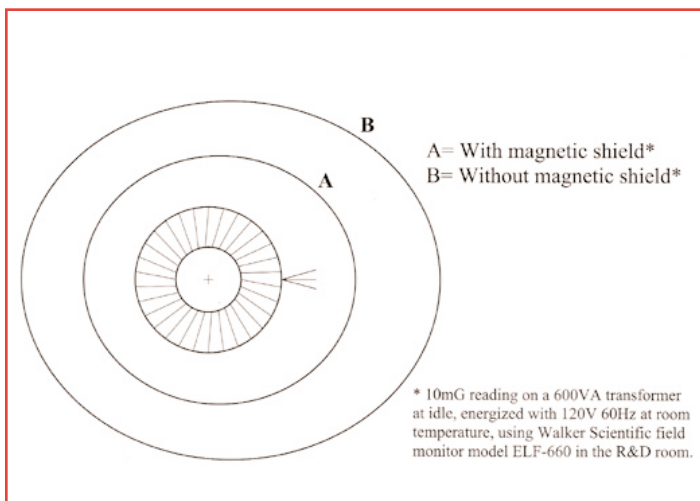

## REGULATION

The load regulation of toroidal power transformers is expressed by the following equation:

$$\%Reg = [(E_{oc} - E_n) / E_{oc}] \times 100$$

$$E_n = \text{Full load voltage}$$

$$E_{oc} = \text{No-Load}$$

Regulation may be improved by using larger diameter wire in the windings or a larger core. This technique is accompanied by a slight increase in size and cost.

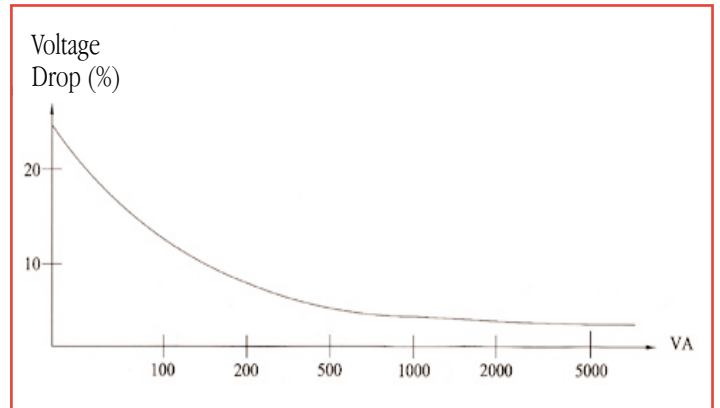

## TOROID EFFICIENCY

The following graph illustrates the effect of increasing load on the efficiency of a toroid for various power ratings.

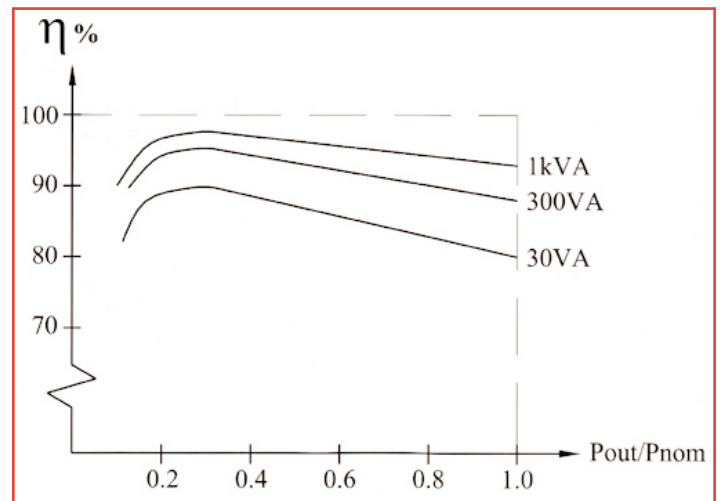

## LINE FREQUENCY

Our standard transformers are designed to operate in 50 or 60Hz circuits. Upon request, we furnish toroids with thinner laminations for operation at frequencies to 2kHz. For even higher frequencies, cores are chosen from such composite materials as ferrite or powdered metal.

## APPLYING TOROIDS TO RECTIFIER POWER SUPPLIES

When used in rectifier circuits, the advantages of toroids may be optimized if consideration is given to how they are applied. AC current in the transformer's secondary is not only influenced by the DC load current, but, just as important, by the circuit configuration. Common circuit configurations are shown as follows:

### Full Wave Bridge (FWB)

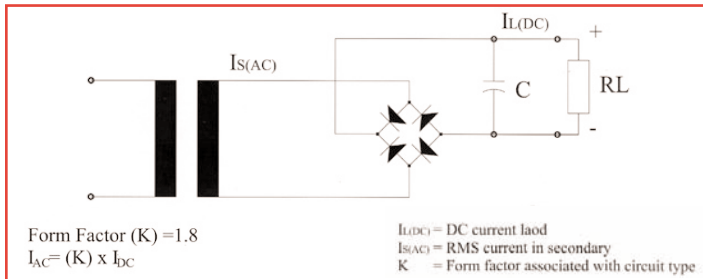

### Full Wave Center Tap (FWCT)

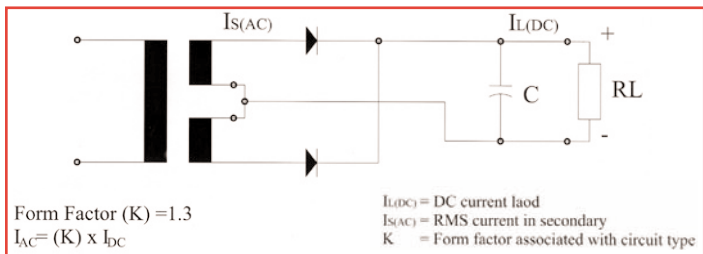

### Full Wave Center Tap (FWCT) With Choke Input

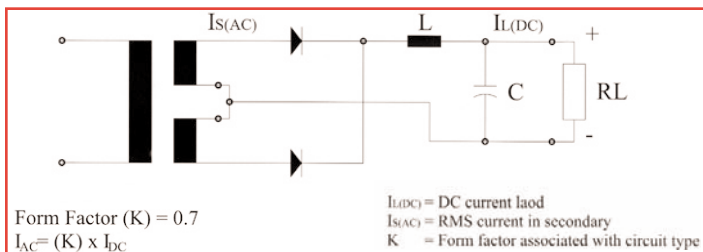

### Full Wave Bridge Tap (FWCT) With Dual Outputs

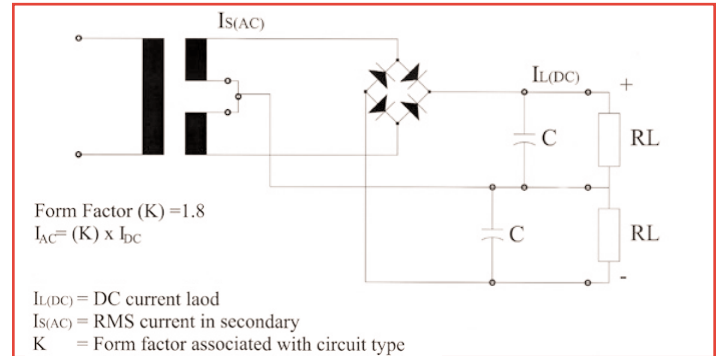

## FORM FACTOR (K)

- $I_{L(DC)}$  = DC current load
- $I_{S(AC)}$  = RMS current in secondary =  $K \times I_{L(DC)}$
- K = Form factor associated with circuit type

The "Form Factor" (K) is related to the rectifier circuit configuration and the wave form of the current in the secondary.

$$I_{AC} = K \times I_{DC}$$

Typical form factor (K) values at capacitor input filter:

Rectifier Type	Form Factor (K)
FWB	1.8
FWCT	1.3
FWCT with choke input	0.7
FWCT with dual outputs	1.8

AMVECO employs computer aided design techniques to optimize the toroidal transformer parameters. Our computer program takes into account the influence of the circuit Form Factor (K) as shown above. When preparing specifications for toroids, it is important that the capacitor value and the voltage drop across the regulator (if any) is furnished.

In some high current applications, a choke input filter will compound savings because inductors yield a lower Form Factor (K). In these circuits, the size of the transformer and the total capacitance are both reduced.

Weight Comparison: Toroid vs. E-I Transformer

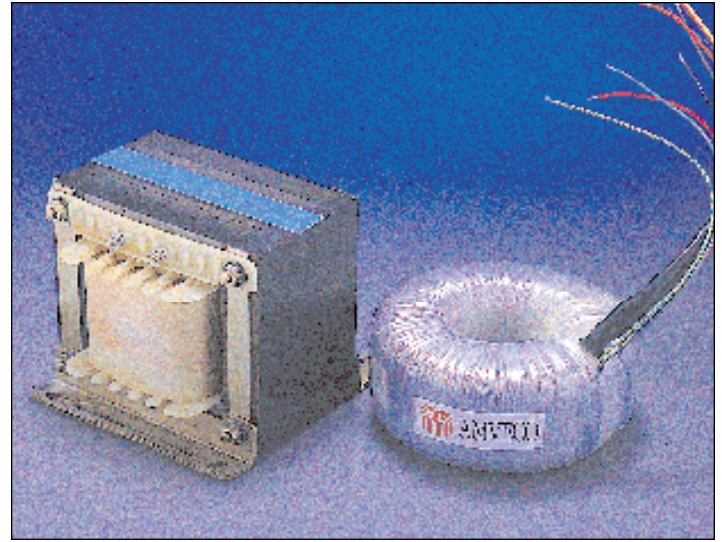
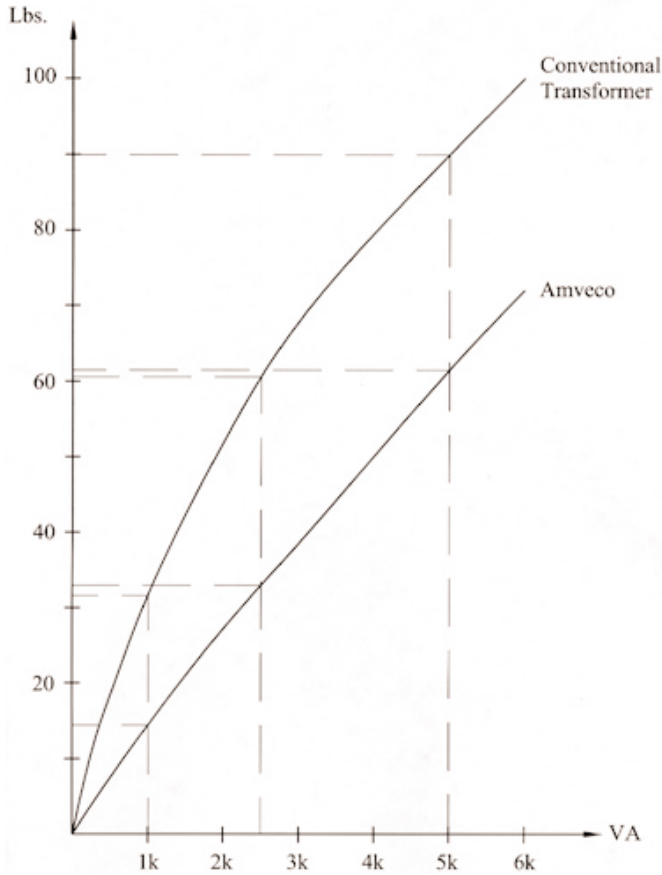

Overall Comparison of 250 VA E/I-Core AMVECO Isolation Transformer vs. 250 VA E-I Core Isolation Transformer

Feature	E-I Core Transformer	AMVECO
Height	4.7" (119 mm)	2.2" (56 mm)
Width	3.9" (99 mm)	4.5" (114 mm)
Depth	4.3" (109 mm)	4.5" (114 mm)
Volume	78.8 sq. in. (508.4 cm <sup>2</sup> )	35.0 sq. in. (225.8 cm <sup>2</sup> )
Dimensional Adaptability	Limited by available dies	All dimensions can be adjusted
Weight	10 lb. (4.5 kg)	5 lb. (2.3 kg)
Mounting Requirements	Four corner bolts	Single bolt through center
Magnetizing Current	10.0 W	1.5 W
No-Load Loss	20.5 mW	0.6 mW
Continuity of Magnetic Path	50% of grain perpendicular	100% parallel grain orientation
Air Gaps	Approximately 180 (60 laminating x 3)	None
Magnetic Properties of Core	Affected by clamping, welding, banding, etc.	Optimized prior to winding and remain stable
Coupling Factor	Limited by bobbin width and layers of windings	Maximized by even winding distribution & close proximity to core
Long-term Reliability	Thermal cycling and vibration steadily degrade performance	Lifetime Warranty



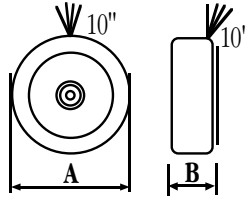

**DISK MOUNTING**

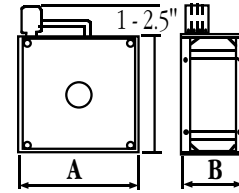

**FLANGE MOUNTING**

Nominal Power (VA)	Copper Losses <sup>(2)</sup> (W)	Core Losses (W)	Dimensions			Dimensions			
			A inch (mm)	B inch (mm)	Weight lb (kg)	A inch (mm)	B inch (mm)	Weight lb (kg)	
50-60 Hz	60Hz								
15	18	3.0	0.20	2.5 (64)	1.3 (33)	0.7 (0.3)	N/A	N/A	
30	36	5.8	0.25	3.0 (76)	1.5 (38)	1.1 (0.5)	N/A	N/A	
50	60	8.6	0.45	3.2 (81)	1.4 (36)	1.6 (0.7)	N/A	N/A	
80	95	12.0	0.60	3.9 (99)	1.5 (38)	2.2 (1.0)	N/A	N/A	
120	145	16.0	0.90	3.9 (99)	1.9 (48)	3.0 (1.4)	N/A	N/A	
160	190	19.0	1.20	4.5 (114)	1.7 (43)	3.8 (1.7)	N/A	N/A	
225	270	20.0	1.40	4.5 (114)	2.0 (51)	4.9 (2.2)	N/A	N/A	
300	360	22.0	1.70	4.6 (117)	2.6 (66)	5.7 (2.6)	N/A	N/A	
400	480	27.0	2.00	5.4 (137)	2.0 (51)	6.5 (3.0)	5.7 (145)	3.3 (84)	8.1 (3.7)
500	600	31.0	2.40	5.4 (137)	2.4 (61)	8.0 (3.6)	5.7 (145)	3.7 (94)	9.6 (4.4)
625	750	36.0	3.10	5.5 (140)	3.2 (81)	9.5 (4.3)	5.7 (145)	4.2 (107)	11.1 (5.0)
800	960	45.0	3.80	6.4 (163)	2.7 (69)	12.3 (5.6)	6.9 (175)	3.9 (99)	14.6 (6.6)
990	1200	45.0	4.70	6.4 (163)	3.0 (76)	16.0 (7.3)	6.9 (175)	4.3 (109)	18.3 (8.3)
1100	1320	45.0	6.50	6.4 (163)	3.3 (84)	17.0 (7.7)	6.9 (175)	4.6 (117)	19.3 (8.8)
1300	1560	60.0	5.70	8.0 (203)	2.6 (66)	20.0 (9.1)	8.3 (211)	3.9 (99)	23.0 (10.4)
1600	1920	62.0	7.10	8.0 (203)	3.0 (76)	23.0 (10.4)	8.3 (211)	4.3 (109)	26.0 (11.8)
1900	2280	65.0	8.50	8.0 (203)	3.4 (86)	26.0 (11.8)	8.3 (211)	4.7 (119)	29.0 (13.2)
2200	2640	73.0	8.10	8.9 (226)	3.3 (84)	29.0 (13.2)	9.3 (236)	5.1 (130)	33.5 (15.2)
2500	3000	79.0	9.70	8.9 (226)	3.5 (89)	33.0 (15.0)	9.3 (236)	5.3 (135)	37.5 (17.0)
2800	3360	89.0	11.00	9.8 (249)	3.1 (79)	35.0 (15.9)	10.2 (259)	4.9 (124)	41.0 (18.6)
3200	3840	91.0	11.00	9.8 (249)	3.5 (89)	42.0 (19.1)	10.2 (259)	5.3 (135)	48.0 (21.8)
3700	4440	93.0	15.00	9.8 (249)	3.9 (99)	46.0 (20.9)	10.2 (259)	5.7 (145)	52.0 (23.6)
4400	5280	112.0	17.00	11.2 (284)	4.3 (109)	53.0 (24.0)	11.6 (295)	6.1 (155)	60.0 (27.2)
5000	6000	112.0	20.00	11.2 (284)	4.7 (119)	62.0 (28.1)	11.6 (295)	6.5 (165)	69.0 (31.3)
6300	7560	130.0	27.00	12.4 (315)	4.7 (119)	76.0 (34.5)	13.8 (351)	6.5 (165)	89.0 (40.4)
8000	9600	140.0	28.00	13.4 (340)	4.7 (119)	88.0 (39.9)	13.8 (351)	6.5 (165)	101.0 (45.8)
10000	12000	140.0	39.00	13.4 (340)	5.9 (150)	120.0 (54.4)	13.8 (351)	7.7 (196)	133.0 (60.3)

The values given are typical values. (2) Copper losses at 25°C ambient temperature and full load.

Over 95% of our sales are custom designs. Because they require no elaborate production tools and are individually wound, toroidal transformers are particularly well suited to custom designs.

Take advantage of our custom design service at no obligation.

Our interactive computer design capabilities enable us to optimize design's for either AC or DC loads.

- **Quick response to Requests for Quotations**
- **Rapid delivery of prototypes**
- **Pre-certified by electrical safety agencies: UL and CSA**
- **Variety of mounting arrangements**
- **Lifetime Warranty**



VISIT OUR WEBSITE FOR INTERACTIVE DESIGN SERVICE.

Company: \_\_\_\_\_ Date: \_\_\_\_\_

Contact Name: \_\_\_\_\_

Address: \_\_\_\_\_ Telephone: \_\_\_\_\_

City: \_\_\_\_\_ State: \_\_\_\_\_ Zip: \_\_\_\_\_ Fax: \_\_\_\_\_

Application: \_\_\_\_\_

Customer P/N: \_\_\_\_\_  New Program  Existing Program

Quote Prices on:  1  10  25  50  100  250  500  1000  2500  5000  10000  25000

ELECTRICAL DATA

- Total Power Rating (VA): \_\_\_\_\_ Duty Cycle \_\_\_\_\_ %
• Input Voltages:  100V  120V  208V  230V  240V  277V  Other: \_\_\_\_\_ V
• Line Frequency:  60Hz  50/60Hz  Other: \_\_\_\_\_ Hz
• Thermal Protection:  Auto Resettable  Non-resettable • Trip Temperature: \_\_\_\_\_ °C
• Maximum Temperature Rise Over Ambient: \_\_\_\_\_ °C • Ambient Temperature: \_\_\_\_\_ °C

PHYSICAL DATA

- Maximum Diameter: \_\_\_\_\_ Maximum Height: \_\_\_\_\_  Not Critical
• Mounting Method:  Standard Steel Washer/Insulating Pads  L-Bracket for Vertical Mounting
 Potted Center Drilled Hole or Threaded Insert  Enclosure
 Clamping Bracket  Flanges  Other \_\_\_\_\_
• Safety Agency Requirements:  UL  CSA  IEC  EN  CE  Medical
• Specify Which Safety Standard: \_\_\_\_\_

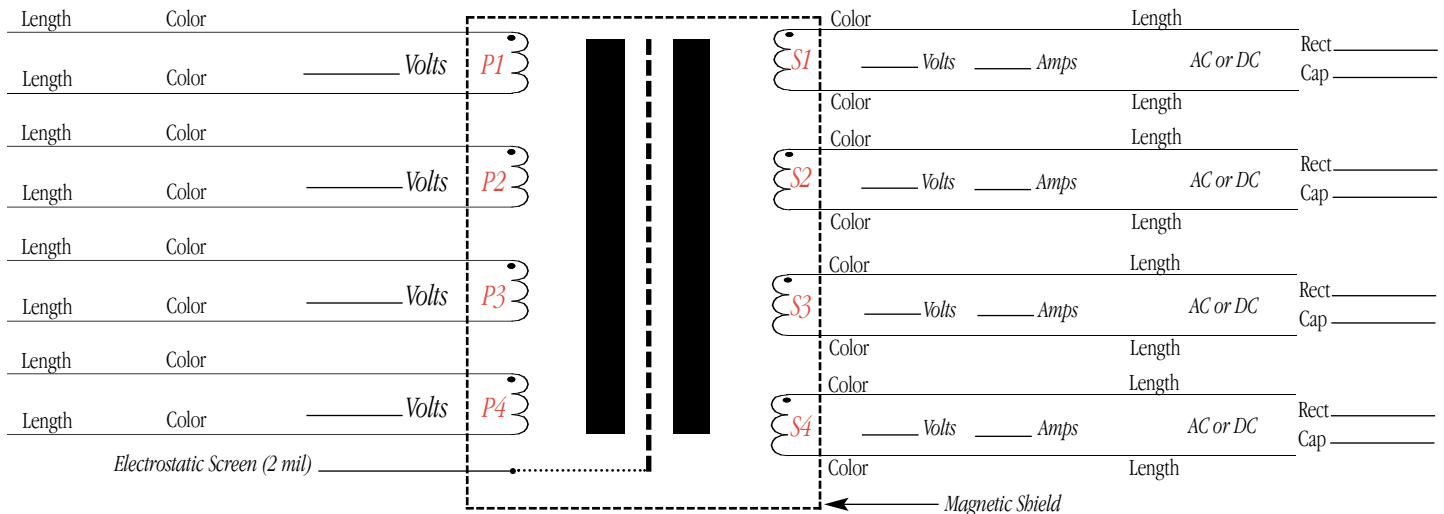

If DC values are listed, please tell us the type of rectifier circuitry and capacitance values.

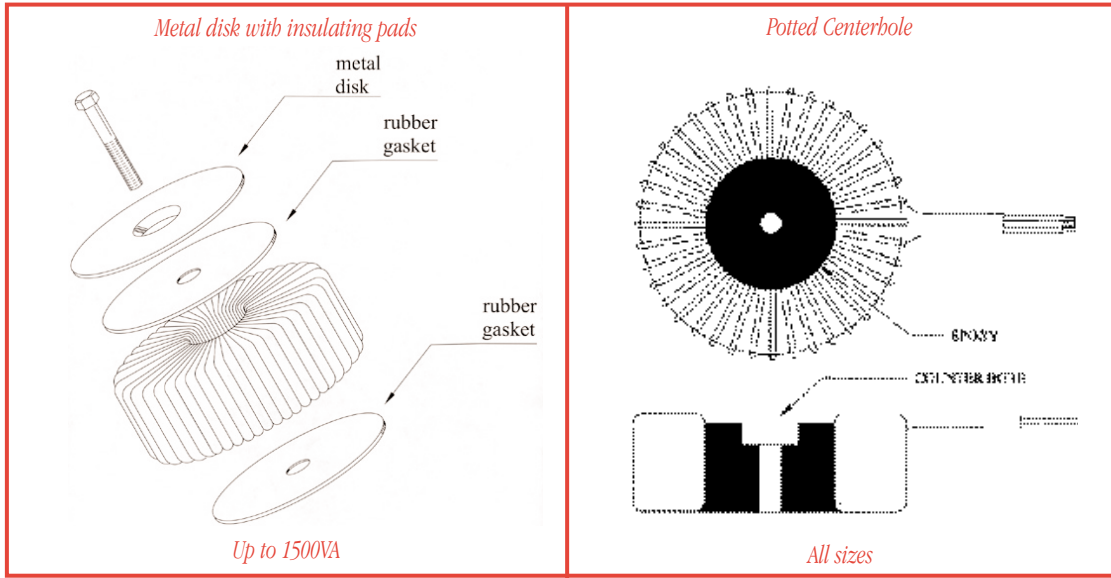

DIMENSIONS OF METAL MOUNTING DISK AND INSULATING PAD				
Power Range VA	OD inch (mm)	Hole inch (mm)	Thickness inch (mm)	Recom. Hardware
20	1.7 (45)	0.18 (4.5)	0.04 (1)	#8
40-60	2.4 (60)	0.20 (5.2)	0.04 (1)	#10
100-150	2.8 (70)	0.26 (6.6)	0.04 (1)	1/4"
200-350	3.5 (90)	0.26 (6.6)	0.05 (1.3)	1/4"
425-800	4.4 (110)	0.26 (6.6)	0.06 (1.5)	1/4"
800-1200	5.2 (130)	0.33 (8.4)	0.07 (1.7)	5/16"
1200-1500	5.6 (145)	0.41 (10.3)	0.07 (1.7)	3/8"

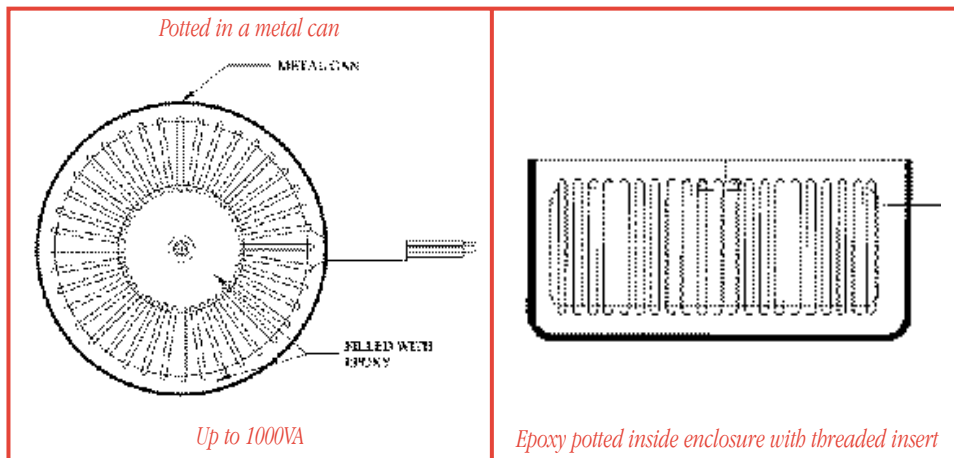

## FLANGE MOUNTS

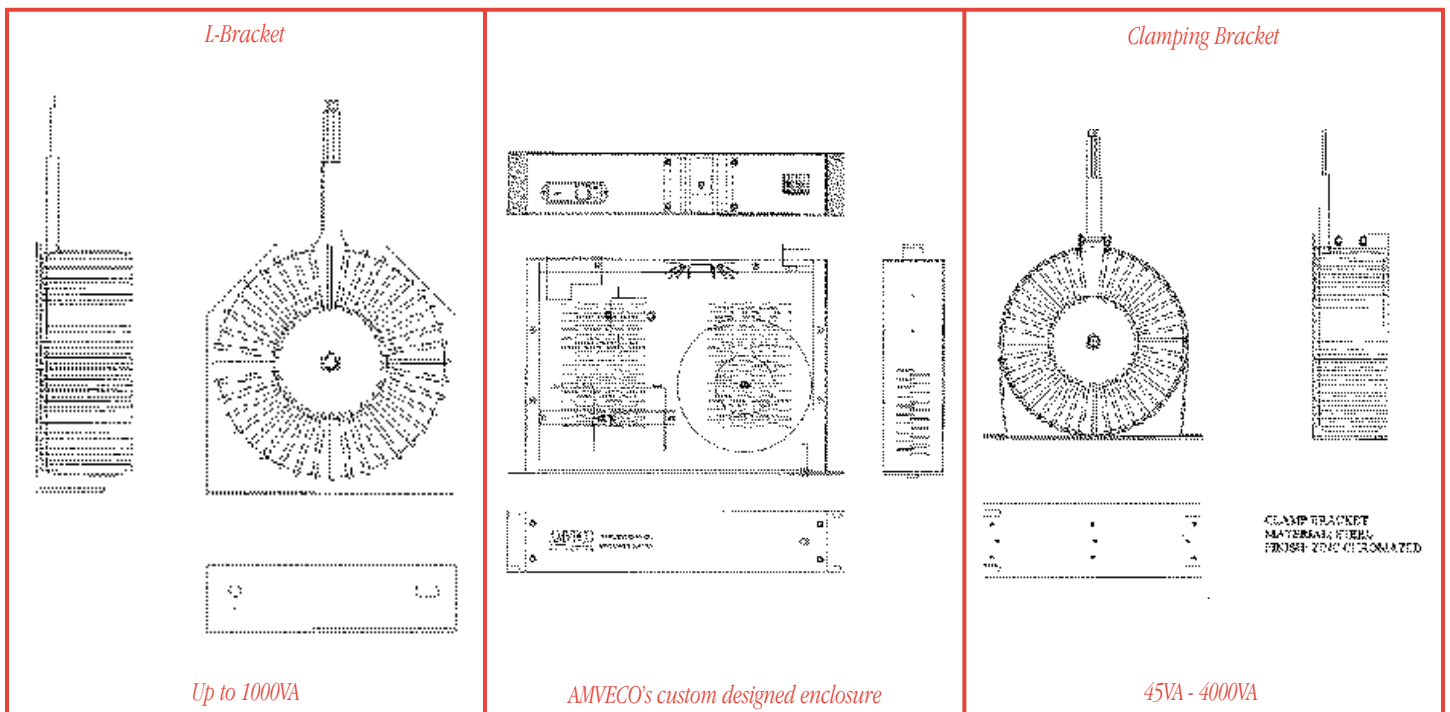
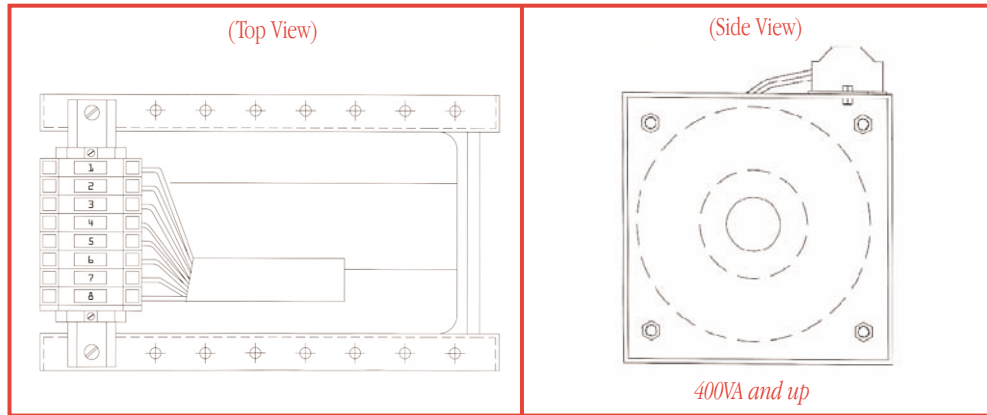

Substantial benefits may be derived from the use of toroids as long as thought is given to their application. The following two considerations are important.

### **A) Shorted Turn Condition**

A completed path by any conductor passing through the center hole of the toroid around the outside constitutes a short circuited turn. As with any short circuit, this condition will result in high circulating currents and, more importantly, high heat.

### **B) Inrush Currents**

The excellent magnetic properties of the toroidal transformer and the high remanence of the grain-oriented silicon steel, under certain circumstances, occasionally leads to high inrush current at turn-on.

To prevent nuisance interruptions due to blown fuses or supply breakers, some simple precautions should be considered. As the power rating of the transformer increases, the potential effect of the inrush current becomes greater. The following table suggests different types of circuit protection according to the toroid's power rating.

<b>TRANSFORMER RATING</b>	<b>SUGGESTED PROTECTION</b>
• 15 to 300VA	None
• 300VA to 1.0kVA	Slow-blow fuse in primary circuit
• 1.0 to 2.0kVA	Small value resistor in series with primary circuit
• 2.0kVA and up	Relay momentarily inserts resistor in primary circuit at start-up, or NTC Thermistors

Our standard mounting options utilize either a single bolt and large washer (disk mount) with no outside structure to act as a conductor, completing the circuit; or two metal flanges (flange mount) which clamp the toroidal like a sandwich with four bolts at the outer periphery, but nothing through the center. The L-Bracket and Clamping Bracket described are both designed to avoid a shorted turn condition.

In addition, in those applications where an even lower in-rush current is desired, AMVECO has developed several proprietary construction techniques. Without added circuitry, both the peak value and the duration of the in-rush current can be reduced. As a matter of fact, AMVECO has manufactured toroidal transformers without any in-rush current at all. In these cases, AMVECO works closely with the customer to meet the specific requirements of the application. A slight increase in the overall size of the transformer is sometimes necessary to facilitate the lower in-rush current.

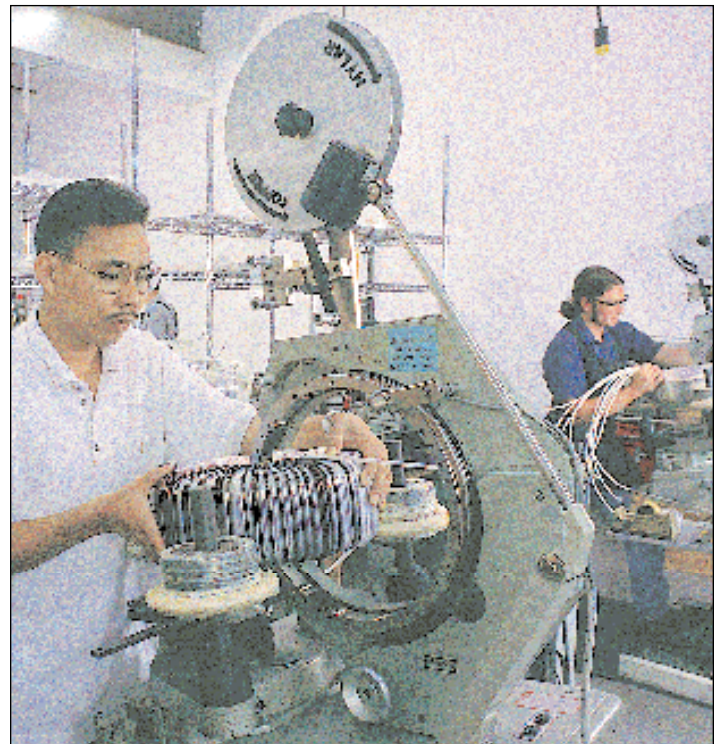



## NORTH AMERICAN 120V/60HZ

- Lifetime warranty
- 120V, 60Hz
- Many popular secondary voltage options
- 18 to 1000VA ratings available
- Listed as recognized/certified components (UL and CSA)
- Class A (105°C)
- Disk mounting hardware included
- 10" color coded self leads

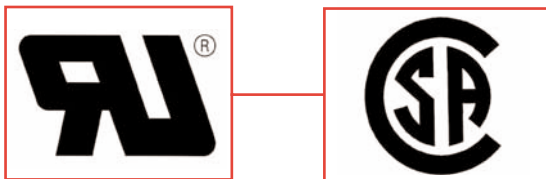

## WINDING CONFIGURATIONS WITH COLOR CODES

**Figure 1**

Single 120V/60Hz Primary w/ Dual Secondaries

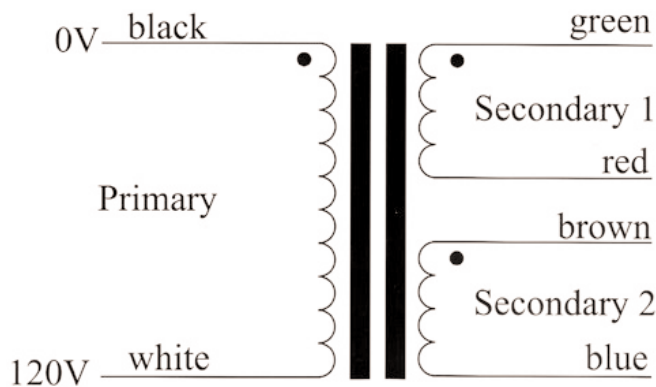

**Figure 2**

Single 120V/60Hz Primary w/ Single Secondary



Nominal Power VA	Secondary Voltage VAC	Secondary Current AAC	AxB <sup>1</sup> in Weight lb Mounting Hardware*	AxB <sup>1</sup> mm Weight kg	Part No.
18	2x9	1.0	2.5x1.3	64x33	AA5018-2009 AA5018-2012 AA5018-2015 AA5018-2018
	2x12	0.7	0.7	0.3	
	2x15	0.6	#8		
	2x18	0.5			
36	2x9	2.0	2.9x1.5	74x38	AA5036-2009 AA5036-2012 AA5036-2015 AA5036-2018
	2x12	1.5	1.1	0.5	
	2x15	1.2	#10		
	2x18	1.0			
60	2x9	3.3	3.3x1.4	84x36	AA5060-2009 AA5060-2012 AA5060-2015 AA5060-2018
	2x12	2.5	1.6	0.7	
	2x15	2.0	#10		
	2x18	1.7			
90	2x12	3.8	3.7x1.5	94x38	AA5090-2012 AA5090-2015 AA5090-2018 AA5090-2022
	2x15	3.0	1.9	0.9	
	2x18	2.5	#10		
	2x22	2.0			
115	2x12	4.8	3.9x1.5	99x38	AA5115-2012 AA5115-2015 AA5115-2018 AA5115-2022
	2x15	3.8	2.2	1.0	
	2x18	3.2	1/4"		
	2x22	2.6			
170	2x12	7.1	3.9x1.9	99x48	AA5170-2012 AA5170-2015 AA5170-2018 AA5170-2022
	2x15	5.7	3.1	1.4	
	2x18	4.7	1/4"		
	2x22	3.9			
220	220	1.0	4.5x1.8	114x46	AA5220-1220 AA5220-2018 AA5220-2022 AA5220-2024
	2x18	6.1	4.0	1.8	
	2x22	5.0	1/4"		
	2x24	4.6			
360	220	1.6	4.5x2.4	114x61	AA5360-1220 AA5360-2024 AA5360-2030 AA5360-2033 AA5360-2038
	2x24	7.5	5.4	2.5	
	2x30	6.0	1/4"		
	2x33	5.5			
450	2x38	4.7			
	220	2.1	5.4x2.0	137x51	AA5450-1220 AA5450-2030 AA5450-2033 AA5450-2038
	2x30	7.5	6.5	3.0	
	2x33	6.8	1/4"		
2x38	5.9				
550	220	2.5	5.4x2.6	137x66	AA5550-1220 AA5550-2030 AA5550-2033 AA5550-2038
	2x30	9.2	8.5	3.7	
	2x33	8.3	1/4"		
	2x38	7.2			
650	120	5.4	5.4x2.8	137x71	AA5650-1120 AA5650-2024 AA5650-2030 AA5650-2042
	2x24	13.5	9.5	4.3	
	2x30	10.8	5/16"		
	2x42	7.7			
790	120	6.6	5.8x2.8	147x71	AA5790-1120 AA5790-2024 AA5790-2030 AA5790-2042
	2x24	16.5	11.5	5.2	
	2x30	13.2	5/16"		
	2x42	9.4			
1000	120	8.3	6.5x2.6	165x66	AA5000-1120 AA5000-2024 AA5000-2030 AA5000-2042
	2x24	20.8	12.4	5.6	
	2x30	16.7	5/16"		
	2x42	11.9			

*The values given are typical values.*

*\*Recommended sizes*

*¹See picture on pages 11 and 13(Disk Mounting).*

*For information about core and copper losses, see page 11.*

*Technical data subject to change without prior notice.*

## INTERNATIONAL PRIMARIES 2X117V, 50/60HZ

- Lifetime warranty
- 2x117V, 50/60Hz primaries
- Many popular secondary voltage options
- 15 to 990VA ratings available
- Listed as recognized/certified components (UL and CSA)
- Class A (105°C)
- Disk mounting hardware included
- 10" color coded self leads



## WINDING CONFIGURATIONS WITH COLOR CODES

Dual 117V 50/60Hz Primaries w/ Dual Secondaries

Multiple primaries must be connected in series or parallel.

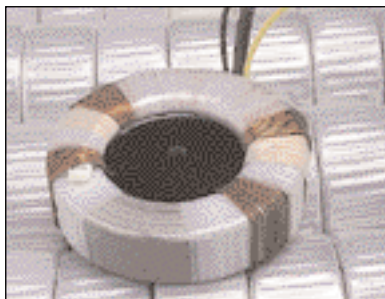
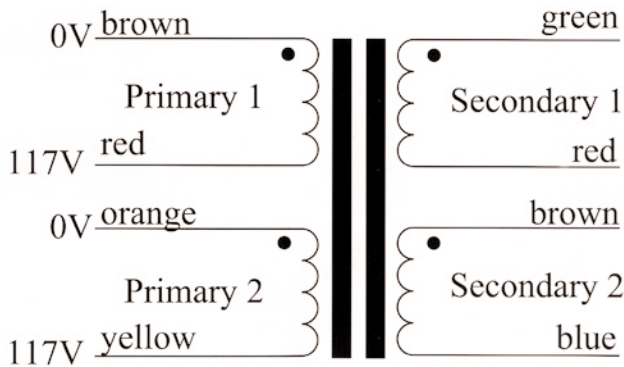

The values given are typical values.

\*Recommended sizes

<sup>1</sup>See picture on pages 11 and 13(Disk Mounting).

For information about core and copper losses, see page 11.

Technical data subject to change without prior notice.

Nominal Power VA	Secondary Voltage VAC	Secondary Current AAC	AxB <sup>1</sup> in Weight lb Mounting Hardware*	AxB <sup>1</sup> mm Weight kg	Part No.
15	2x6	1.25	2.5x1.3 0.7 #8	64x33 0.3	AA50152-006
	2x9	0.83			AA50152-009
	2x12	0.62			AA50152-012
	2x15	0.50			AA50152-015
	2x18	0.42			AA50152-018
	2x22	0.34			AA50152-022
30	2x6	2.50	3.0x1.5 1.1 #10	76x38 0.5	AA50302-006
	2x9	1.67			AA50302-009
	2x12	1.25			AA50302-012
	2x15	1.00			AA50302-015
	2x18	.88			AA50302-018
	2x22	0.68			AA50302-022
50	2x6	4.2	3.2x1.4 1.6 #10	81x36 0.7	AA50502-006
	2x9	2.8			AA50502-009
	2x12	2.1			AA50502-012
	2x15	1.7			AA50502-015
	2x18	1.4			AA50502-018
	2x22	1.1			AA50502-022
95	2x6	7.0	3.9x1.5 2.2 1/4"	99x38 1.0	AA50952-006
	2x9	4.7			AA50952-009
	2x12	3.5			AA50952-012
	2x15	2.8			AA50952-015
	2x18	2.3			AA50952-018
	2x22	1.8			AA50952-022
140	2x6	11.7	3.9x1.9 3.0 1/4"	99x48 1.4	AA51402-006
	2x9	7.8			AA51402-009
	2x12	5.8			AA51402-012
	2x15	4.7			AA51402-015
	2x18	3.9			AA51402-018
	2x22	3.2			AA51402-022
185	2x6	19.2	4.5x1.9 4.0 1/4"	114x48 1.8	AA51852-006
	2x9	12.8			AA51852-009
	2x12	9.6			AA51852-012
	2x15	7.7			AA51852-015
	2x18	6.2			AA51852-018
	2x22	4.9			AA51852-022
240	2x6	28.0	4.5x2.1 4.8 1/4"	114x53 2.2	AA52402-006
	2x9	18.8			AA52402-009
	2x12	14.0			AA52402-012
	2x15	11.2			AA52402-015
	2x18	9.3			AA52402-018
	2x22	7.4			AA52402-022
300	2x6	42.0	4.6x2.6 5.7 1/4"	117x66 2.6	AA53002-006
	2x9	28.0			AA53002-009
	2x12	21.0			AA53002-012
	2x15	16.8			AA53002-015
	2x18	14.0			AA53002-018
	2x22	11.2			AA53002-022
375	2x6	50.0	5.4x2.0 6.7 1/4"	137x51 3.0	AA53752-006
	2x9	33.3			AA53752-009
	2x12	25.0			AA53752-012
	2x15	18.8			AA53752-015
	2x18	15.0			AA53752-018
	2x22	11.7			AA53752-022
460	2x6	66.7	5.4x2.6 7.9 1/4"	137x66 3.6	AA54602-006
	2x9	44.4			AA54602-009
	2x12	33.3			AA54602-012
	2x15	25.0			AA54602-015
	2x18	20.0			AA54602-018
	2x22	15.0			AA54602-022
625	2x6	104.2	5.5x3.2 9.5 1/4"	140x81 4.3	AA56252-006
	2x9	69.5			AA56252-009
	2x12	51.7			AA56252-012
	2x15	39.5			AA56252-015
	2x18	31.2			AA56252-018
	2x22	23.8			AA56252-022
800	2x6	133.3	6.4x2.7 12.3 5/16"	163x69 5.6	AA58002-006
	2x9	88.9			AA58002-009
	2x12	66.7			AA58002-012
	2x15	51.7			AA58002-015
	2x18	41.5			AA58002-018
	2x22	31.2			AA58002-022
990	2x6	165.0	6.5x3.0 15.2 5/16"	165x76 6.9	AA59902-006
	2x9	110.0			AA59902-009
	2x12	82.5			AA59902-012
	2x15	63.0			AA59902-015
	2x18	50.0			AA59902-018
	2x22	37.5			AA59902-022



# MEDICAL GRADE HIGH ISOLATION TOROIDAL TRANSFORMERS



## QUAD PRIMARIES - 100V, 120V, 220V, 240V - 50/60HZ

Medical Power & Isolation Transformers 50/60Hz

Multiple primaries must be connected in series or parallel.

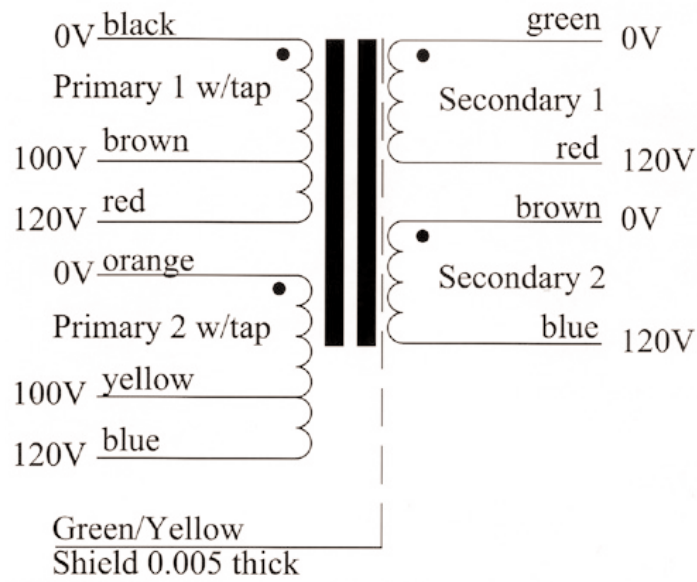

NOTE: (suffix) SS=(Single Secondary) Secondary 1 only  
 (suffix) DS=(Dual Secondary) Secondary 1 & 2

- Units rated below 1000VA come with metal disk and insulating pads.
- Units rated 1000VA and larger are center potted.



Our part numbers - MT100 through MT5000 carry full TUV BAUARTMARK

## (UL 544, UL 2601, IEC 601, CSA 22.2 NO. 601.1) RECOGNIZED MEDICAL POWER/ISOLATION TRANSFORMERS

Nominal Power VA	Secondary Current at 120 V	Secondary Current at 240 V	AxB' in Weight lb	AxB' mm Weight kg	Part No.
100	.83A		4.0x2.0 2.7	102x51 1.2	MT0100SS
100	.83A	.42A	4.0x2.0 2.7	102x51 1.2	MT0100DS
230	1.92A		4.6x2.4 5.2	117x61 2.4	MT0230SS
230	1.92A	.96A	4.6x2.4 5.2	117x61 2.4	MT0230DS
400	3.33A		5.5x2.5 8.0	140x64 3.6	MT0400SS
400	3.33A	1.67A	5.5x2.5 8.0	140x64 3.6	MT0400DS
600	5.00A		6.2x3.1 13.0	157x79 5.9	MT0600SS
600	5.00A	2.5A	6.2x3.1 13.0	157x79 5.9	MT0600DS
750	6.25A		6.6x3.0 14.0	168x79 6.4	MT0750SS
750	6.25A	3.12A	6.6x3.1 14.0	168x76 6.4	MT0750DS
1000	8.33A	4.16A	6.9x3.5 20.0	175x89 9.1	MT1000DS
1500	12.5A	6.25A	8.2x4.0 28	208x102 12.7	MT1500DS
2000	16.6A	8.33A	9.1x4.4 35	231x112 15.9	MT2000DS
2500	20.8A	10.4A	9.4x4.5 39	239x114 17.7	MT2500DS
3000	25.0A	12.5A	10.0x4.3 47	254x109 21.3	MT3000DS
3750	31.2A	15.6A	10.5x4.9 65	267x124 29.5	MT3750DS
5000	41.6A	20.8A	11.6x5.4 78	295x137 35.4	MT5000DS
6250	52.0A	26.0A	12.0x5.6 90	305x143 40.8	MT6250DS
7500	62.5A	31.2A	12.0x5.5 100	305x140 45.4	MT7500DS
8750	72.9A	36.4A	12.5x5.5 110	318x140 49.9	MT8750DS
10000	83.3A	41.6A	13.0x5.2 120	330x132 54.4	MT10000DS

The values given are typical values.  
 Technical data subject to change without prior notice.

For mounting information see diagrams on page 13.

## AUTOTRANSFORMERS YIELD REDUCED SIZE AND COSTS

Frequently, in applications calling for simple voltage step-up or step-down, and where there is no requirement for electrical isolation, applying an autotransformer will result in significant size and weight reductions as well as cost. The power rating of an autotransformer is given by the expression:

$$P_{\text{rated}} = P_{\text{out}} \times (V_{\text{hi}} - V_{\text{low}}) / V_{\text{hi}}$$

$V_{\text{low}}$  = voltage from lower voltage tap (input or output)

$V_{\text{hi}}$  = voltage across higher voltage tap (output or input)

### STEP UP AUTOTRANSFORMER

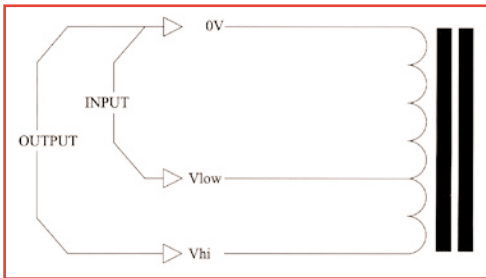

### STEP DOWN AUTOTRANSFORMER

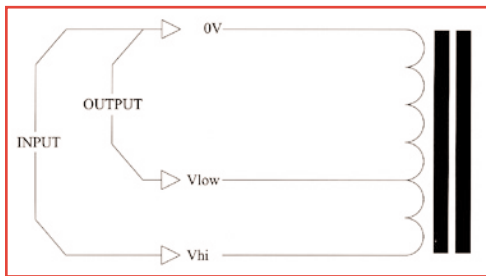

A rule of thumb to apply when considering an autotransformer is that the voltage across the entire winding should be less than or equal to two times (2x) the value of the lowest voltage tap ( $V_{\text{hi}} < 2V_{\text{low}}$ ).

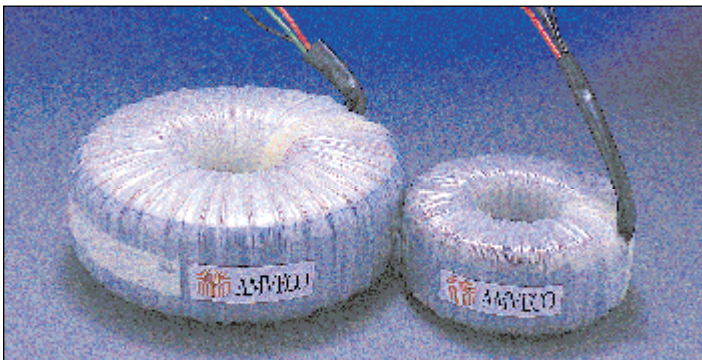

1500VA Isolation Transformer and 1500VA Autotransformer



### THREE-PHASE TRANSFORMERS

3-Phase toroidal transformers are simply three separate single phase units. When convenient, they may be mounted as individual units, adding flexibility to the design of the housing or, in many cases, stacked together side by side or stacked on top of each other. For higher powered units, the relative assembly labor is less using toroids where each phase may be handled separately (usually by one person). Compare this to E-I transformer installations where a large single unit must be moved (requiring several workers and a hoist).

## CURRENT SENSING TRANSFORMERS

for low voltage (up to 1.1kV) and medium voltage (up to 25kV) applications

In response to the increasing demand for current sensing transformers, AMVECO has entered into cooperative relationships with well established Far East manufacturers to offer high quality custom designed Current Transformers at very competitive prices. In addition to existing product line of standard designs as shown in our separate product brochure, we will gladly help you with designs to your exact specifications.

### TYPICAL APPLICATIONS

- Control Panels, Relay Panels, Metering Panels
- Energy Meters and Power Monitors
- Switch Gear, Control Gears, Switch Boards
- Circuit Breakers, Electricity Protection Systems
- Electronics and Instrumentation Measurements
- Power (Mega VA) Transformer Protections
- Trivector Meter, Watt/Var Meter
- Current Recorders, Sensors
- Laboratory Standards

### PRODUCT RANGE

- Miniature CT's For Use Inside Energy Meter, Instrumentation
- Metering, Measuring CT's
- Relay Class, Protection CT's
- Interposing CT's
- Summation CT's

### TECHNICAL SPECIFICATIONS

- Primary Current Range: 5 Amp. to 5000 Amp.
- Secondary Current: 0.1 A, 0.5 A, 1 A, 5 A or Customer Specified
- Primary Style Options: Window Type (Bushing Type)  
Wound Type with Primary Terminals  
Primary Projection with Copper Bus Bar
- Burden Value: B 0.1 to B 1.8, B1 to B8 or 2.5VA to 200VA
- Cont. Rating Factor (RF): 1.33 Times Rated Primary Current at 30°C or as Customer Specified
- Short Time Thermal Current: 50kA, for 1 sec. or as Customer Specified
- Rated Dynamic Peak Current: 2.5 Times Rated Short Time Thermal Current
- Accuracy Class: As Per Customer Specification and Relevant Standards

### CONSTRUCTION OPTIONS

- Encapsulation: Resin Casting, Resin Dipping, Plastic Casting, Tape Insulated
- Window Shape: Round, Rectangle, Composite
- Secondary Termination: Flexible Lead Wire with Crimped on Terminals  
PC Board Terminal Pins (Small CT's), Male Terminals, Female Terminal Bush

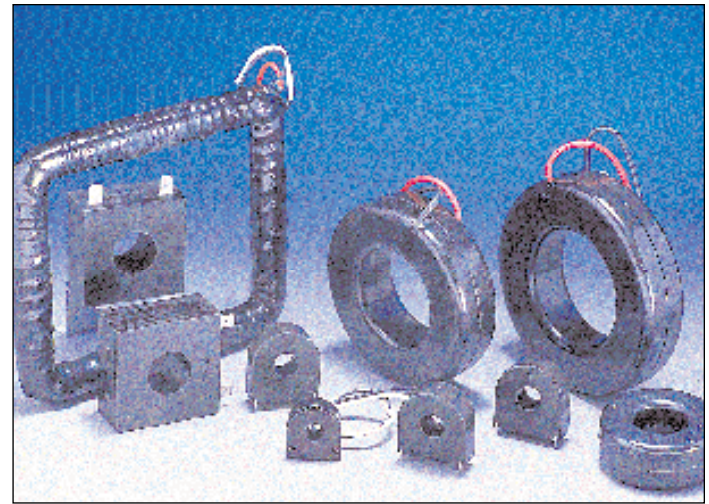

### STANDARD PRODUCT TESTING

- All products are manufactured and tested in compliance with IEC 185, UL 1244, BS 3938, ANSI 57.13
- Type tests performed at certified testing laboratories
- All test data carries traceability

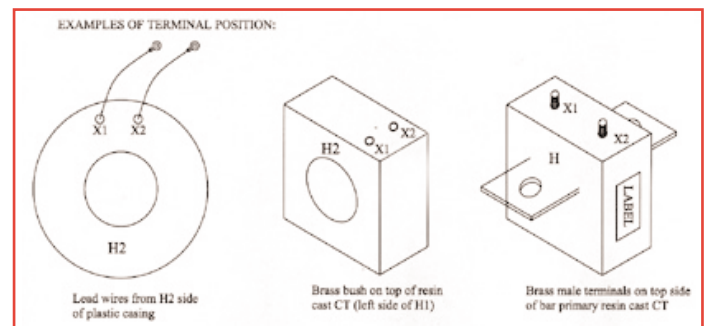
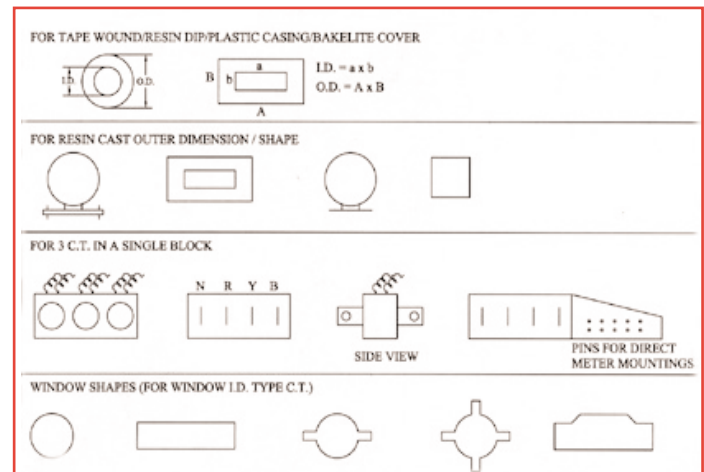

For more information on our CTS, request our full line CT brochure.

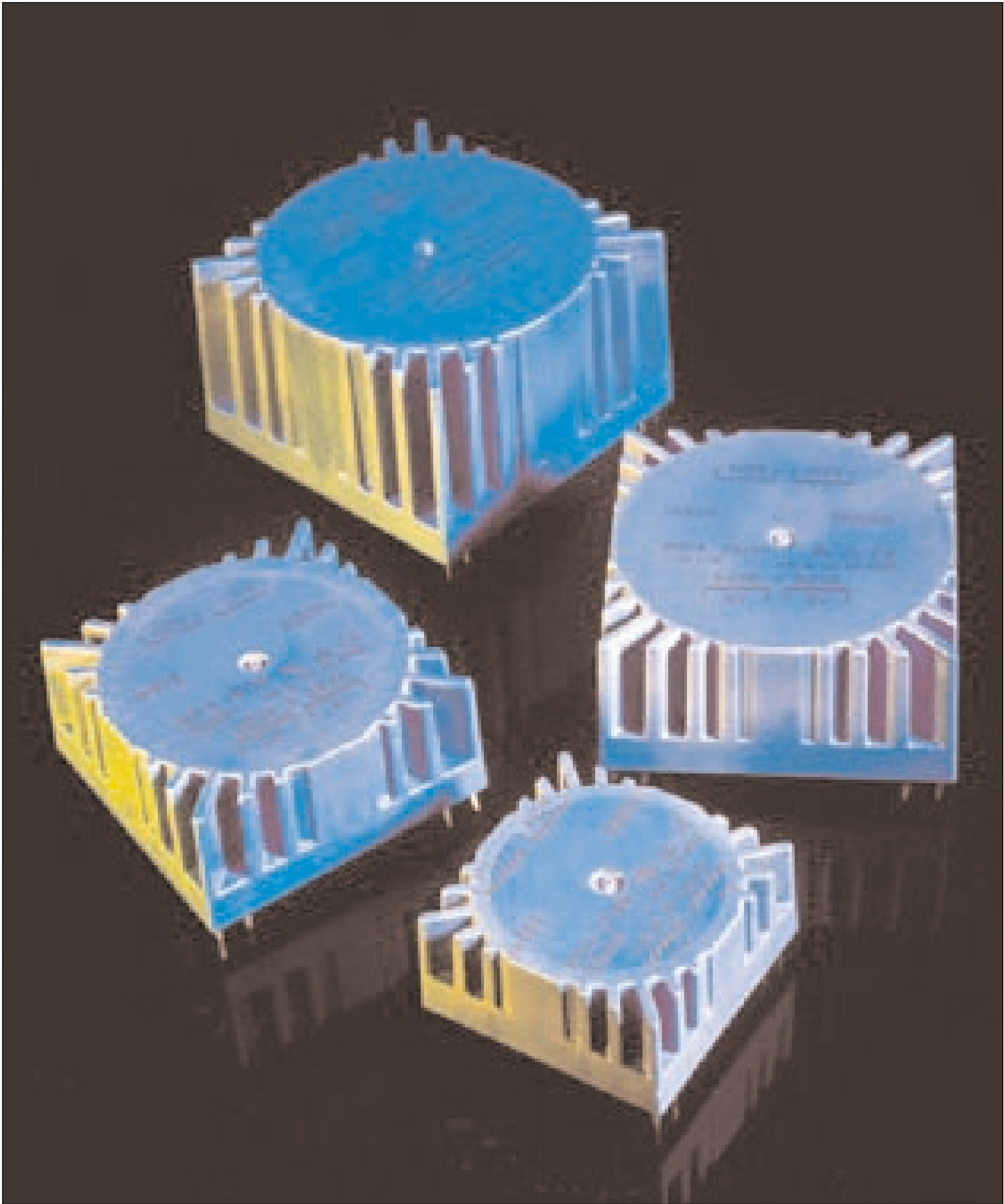

Power VA	Part Number	Sec-Full Load V	Current mA	No Load Voltage	I No-Load	Reg. %	Δt °C	Eff %	Dim. LxWxH mm	Pin Layout	
										XY mm	Pin Size mm
1.6	70000	2x7	114	2x8.9	1.0 (mA)	29	10	77	39.6x39.6x18.5 82 grams	35.56	1.0x0.5
	70001	2x9	89	2x11.6							
	70002	2x12	67	2x15.4							
	70003	2x15	53	2x19.3							
	70004	2x18	44	2x23.4							
70005	2x22	36	2x28.2								
3.2	70010	2x7	229	2x10.2	1.5 (mA)	43	20	70	44.7x44.7x19.5 110 grams	40.64	1.0x0.5
	70011	2x9	178	2x13.0							
	70012	2x12	133	2x17.3							
	70013	2x15	107	2x21.4							
	70014	2x18	89	2x25.7							
70015	2x22	73	2x31.3								
5.0	70020	2x7	357	2x9.7	2.0 (mA)	40	29	68	49.7x49.7x19.5 144 grams	45.72	1.0x0.5
	70021	2x9	278	2x12.4							
	70022	2x12	208	2x17.0							
	70023	2x15	167	2x21.3							
	70024	2x18	139	2x25.5							
70025	2x22	114	2x30.5								
7.0	70030	2x7	500	2x9.5	3.0 (mA)	34	25	74	49.7x49.7x23.1 174 grams	45.72	1.0x0.5
	70031	2x9	389	2x12.2							
	70032	2x12	292	2x16.2							
	70033	2x15	233	2x20.3							
	70034	2x18	194	2x24.3							
70035	2x22	159	2x29.7								
10.0	70040	2x7	714	2x8.3	3.0 (mA)	20	24	82	55.0x55.0x26.0 252 grams	50.80	1.0x0.5
	70041	2x9	556	12x10.8							
	70042	2x12	417	2x14.4							
	70043	2x15	333	2x18.0							
	70044	2x18	278	2x21.7							
70045	2x22	227	2x26.3								
15.0	70050	2x7	1071	2x8.9	4.0 (mA)	23	27	80	60.0x60.0x26.3 304 grams	55.88	1.0x0.5
	70051	2x9	833	2x11.1							
	70052	2x12	625	2x14.8							
	70053	2x15	500	2x18.5							
	70054	2x18	417	2x22.2							
70055	2x22	341	2x27.2								
25.0	70060	2x7	1785	2x8.3	5.0 (mA)	19	28	83	60.0x60.0x37.5 435 grams	55.88	1.0x0.5
	70061	2x9	1377	2x10.7							
	70062	2x12	1041	2x14.3							
	70063	2x15	832	2x17.8							
	70064	2x18	694	2x21.4							
70065	2x22	568	2x26.2								
35.0	70070	2x7	2500	2x8.0	7.0 (mA)	17.7	31	81	72.0x72.0x37.5 525 grams	66.04	1.0x1.0
	70071	2x9	1944	2x10.6							
	70072	2x12	1458	2x14.0							
	70073	2x15	1167	2x17.6							
	70074	2x18	972	2x20.9							
70075	2x22	795	2x25.7								
50.0	70080	2x7	3571	2x8.1	8.0 (mA)	15.5	30	86	82.4x82.4x37.5 685 grams	76.20	1.0x1.0
	70081	2x9	2777	2x10.4							
	70082	2x12	2083	2x13.9							
	70083	2x15	1666	2x17.3							
	70084	2x18	1388	2x20.8							
70085	2x22	1136	2x25.4								

Dimensions in mm. Electrical measurements @ 20°C ambient temperature.  
All data subject to change without prior notice.

The attractive 70000-series PC Mount toroidal step-down transformers offers the design engineer the same features as our non-encapsulated toroidal power transformers, namely, very low EMR (magnetic stray-fields), quiet operation, low temperature rise, low profile, low no-load current and very low no-load losses.

## STANDARD FEATURES

- Primary voltage of 115V or 230V at 50 / 60Hz.
- Safety standard certifications (UL 506, UL 1950 (UL File #E145880), VDE 0805, IEC 950, EN 60950.
- UL File #122978 recognized for insulation Class A (105C). Meets all requirements of Class E (125C)
- UL and VDE certifications to +40°C (1.6VA-25VA)
- Hipot testing at 4000V between primary and secondary. (VDE0550)
- Maximum ambient temperature of +60°C for 1.6VA- 25VA, +40°C for 35VA and 50VA models

## CUSTOM DESIGN OPTIONS

With minimum order of 1000 pieces custom specified primary and secondary voltages are available.

Please contact the Houston factory or your local Amveco sales representative for details.

## WIRE DIAGRAM AND TERMINAL PIN LAYOUT

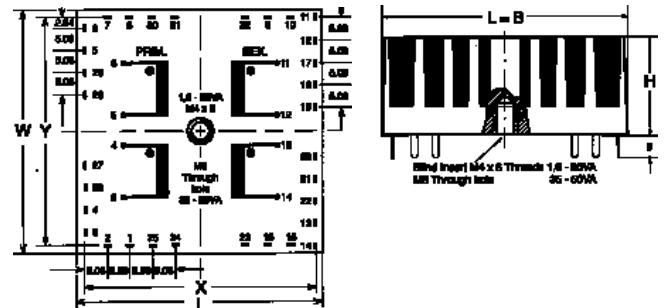

## NOTES

For 230 volt operation, connect primaries in series by connecting pins 5 & 4 together and apply 230 volts across pins 6 & 3.

For 115 volt operation, connect primaries in parallel by connecting pins 6 & 4 together and pins 5 & 3 together; apply 115 volts across pins 6 & 5.

To parallel the secondaries, connect pins 14 to 12 and 13 to 11; take the output across pins 14 and 13.

To place the secondaries in series, connect pins 13 to 12 and take the output across pins 14 and 11.

Minimum order quantity is 500 pieces per part number. For less than 500 pieces, please contact our distributor Digi-Key Corporation at 800-344-4539 or order on line at [www.digikey.com](http://www.digikey.com).

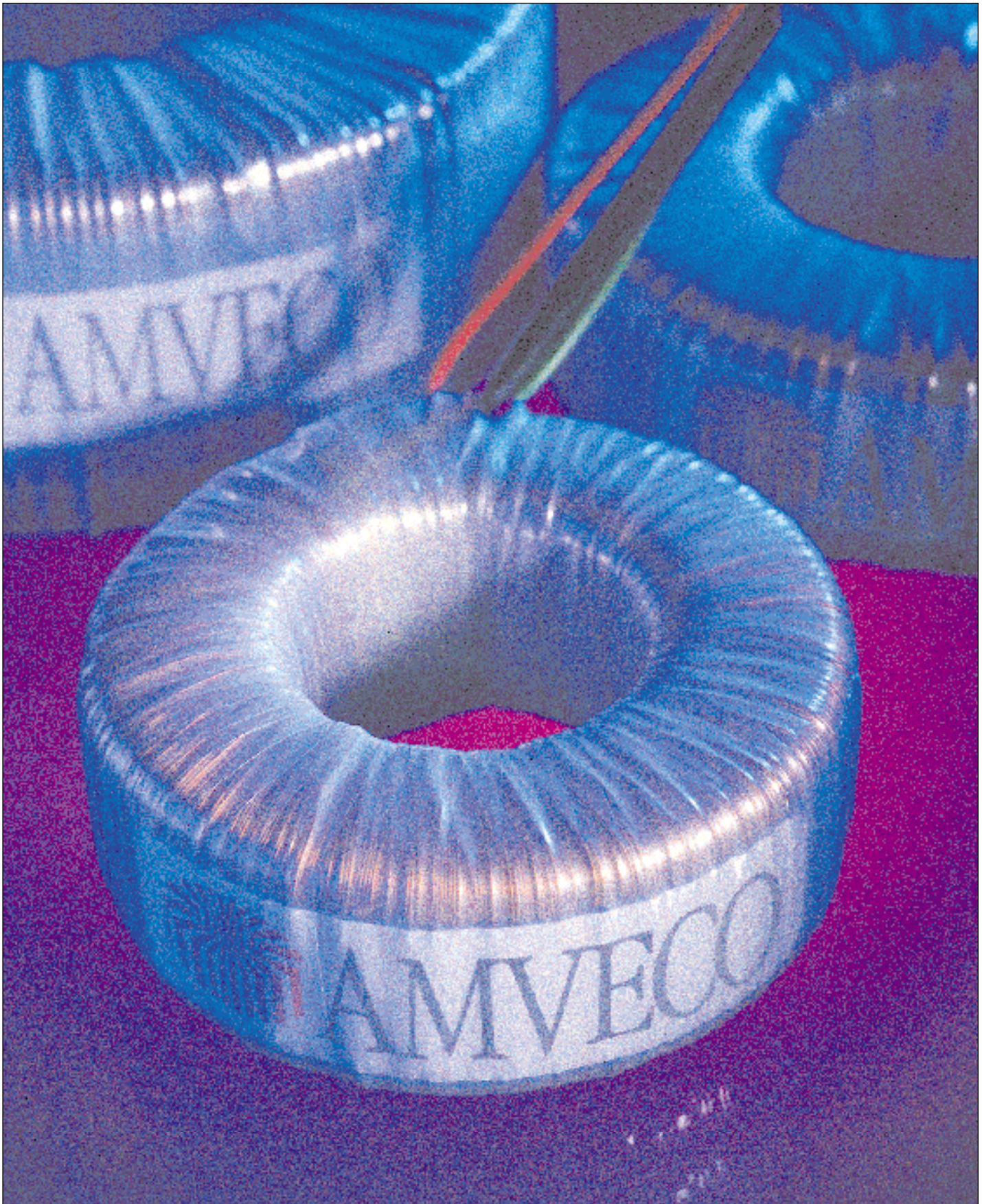



Power VA	Part Number	Sec-Full Load V	Current mA	No Load Voltage	I No-Load	Reg. %	Δt °C	Eff %	Dim. ODXxDxHT mm
1.6	62000	2x7	114	2x8.94	1.0 (mA)	29	10	77	57.5x7.0x17.0 71 (grams)
	62001	2x9	89	2x11.63					
	62002	2x12	67	2x15.43					
	62003	2x15	53	2x19.30					
	62004	2x18	44	2x23.41					
3.2	62005	2x22	36	2x28.19	1.5 (mA)	41	20	70	42.0x7.0x17.5 89 (grams)
	62010	2x7	229	2x10.2					
	62011	2x9	178	2x13.0					
	62012	2x12	133	2x17.3					
	62013	2x15	107	2x21.4					
5.0	62014	2x18	89	2x25.7	2.0 (mA)	45	29	70	47.0x6.0x18.0 115 (grams)
	62015	2x22	73	2x31.3					
	62020	2x7	357	2x9.7					
	62021	2x9	278	2x12.4					
	62022	2x12	208	2x17.0					
7.0	62023	2x15	167	2x21.3	3.0 (mA)	34	25	74	47.0x6.0x21.5 145 (grams)
	62024	2x18	139	2x25.5					
	62025	2x22	114	2x30.5					
	62030	2x7	500	2x9.5					
	62031	2x9	389	2x12.2					
10.0	62032	2x12	292	2x16.2	3.0 (mA)	20	24	82	53.5x6.8x23.5 216 (grams)
	62033	2x15	233	2x20.3					
	62034	2x18	194	2x24.3					
	62035	2x22	159	2x29.7					
	62040	2x7	714	2x8.3					
15.0	62041	2x9	556	12x10.8	4.0 (mA)	23	27	81	57.5x7.0x24.0 262 (grams)
	62042	2x12	417	2x14.4					
	62043	2x15	333	2x18.0					
	62044	2x18	278	2x21.7					
	62045	2x22	227	2x26.3					
25.0	62050	2x7	1071	2x8.9	5.0 (mA)	19	28	84	58.0x13.8x34.5 388 (grams)
	62051	2x9	833	2x11.1					
	62052	2x12	625	2x14.8					
	62053	2x15	500	2x18.5					
	62054	2x18	417	2x22.2					
35.0	62055	2x22	341	2x27.2	7.0 (mA)	17.7	31	85	72.0x17.0x33.5 453 (grams)
	62060	2x7	1785	2x8.3					
	62061	2x9	1377	2x10.7					
	62062	2x12	1041	2x14.2					
	62063	2x15	832	2x17.8					
50.0	62064	2x18	694	2x21.4	8.0 (mA)	15.5	30	86	78.0x22.5x35.0 670 (grams)
	62065	2x22	568	2x26.2					
	62070	2x7	2500	2x8.4					
	62071	2x9	1944	2x10.6					
	62072	2x12	1458	2x14.0					
62073	2x15	1166	2x17.6	8.0 (mA)	15.5	30	86	78.0x22.5x35.0 670 (grams)	
	62074	2x18	972						2x20.9
	62075	2x22	795						2x25.7
	62080	2x7	3571						2x8.1
	62081	2x9	2777						2x10.4
62082	2x12	2083	2x13.8	8.0 (mA)	15.5	30	86	78.0x22.5x35.0 670 (grams)	
	62083	2x15	1666						2x17.3
	62084	2x18	1388						2x20.7
	62085	2x22	1136						2x25.4

(Electrical measurements @ 20°C ambient temperature)  
All data subject to change without prior notice.

The 62000-series Miniature toroidal step-down transformers offers the design engineer the same features as our larger toroidal power transformers, namely, very low EMR (magnetic strayfields), quiet operation, low temperature rise, low profile, low no-load current and very low no-load losses.

## STANDARD FEATURES

- Primary voltage of 115V or 230V at 50 / 60Hz.
- Safety standard certification (UL 506), design construction meet UL 1950, VDE 0805, IEC 950, EN 60950.
- UL recognized for insulation Class A (105C). Meets all requirements of Class E (125C)
- UL certifications to +40 °C (1.6VA-25VA)
- Hipot testing at 4000V between primary and secondary. (VDE0550)
- Maximum ambient temperature of +60 °C
- Epoxy potted center with through hole for M4 bolt

## CUSTOM DESIGN OPTIONS

With minimum order of 1000 pieces custom specified primary and secondary voltages are available. Please contact the Houston factory or your local Amveco sales representative for details.

## WIRE DIAGRAM AND SCHEMATICS

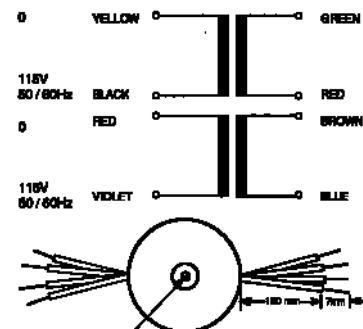

For 230V operation, connect primaries in series by connecting black and red lead wires together and apply 230V across yellow and violet leads wires.

For 115V operation, connect primaries in parallel by connecting yellow and red lead wires together and black and violet leads wires.

To parallel the secondaries, connect green and brown wires and red and blue together. To connect the secondaries in series, the red and brown wires are connected together. Take the output across the green and blue wires.

Minimum order quantity is 500 pieces per part number. For less than 500 pieces of part number 62060 through 62085, please contact our distributor Digikey Corporation at 800-344-4539 or order on line at [www.digikey.com](http://www.digikey.com)

In addition to toroidal transformers, Amveco designs and manufactures toroidal chokes for DC-filtering and AC-circuits. As with transformers, toroidal chokes also offer significant savings in both size and weight compared to a laminated core. Presently, we manufacture chokes from 0.2 Ws to 25 Ws. AMVECO has developed its own design software which allows us to design and manufacture to your specific needs. With in-house capabilities for both core-making and core-cutting, we can offer fast turn-around for both prototypes and production units.

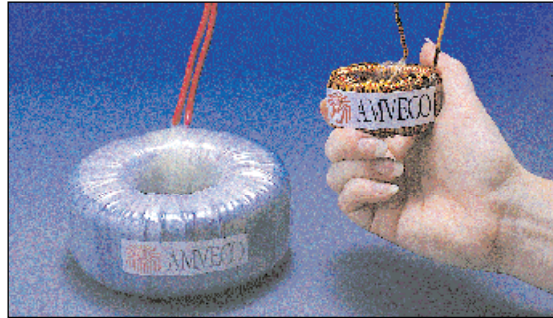

Part Number	Current I DC (A)	Current RMS	L (mH)	Power (WS)	Losses Core-Copper	OD x HT (Inches)	OD x HT (mm)	WT (lbs.)	WT (kg)
L0540	5	3.5	40	0.5	1.5 - 12.8	3.8 x 1.9	97 x 48	2.5	1.1
L0560	5	3.5	60	0.75	3 - 13.8	4.6 x 2.0	117 x 51	4	1.8
L1020	10	7	20	1	4 - 16.7	5.5 x 2.0	140 x 51	6	2.7
L1040	10	7	40	2	5 - 23.4	5.5 x 2.4	140 x 61	8	3.6
L1060	10	7	60	3	7 - 28.6	5.9 x 2.8	150 x 71	11.5	5.2
L1510	15	10.6	10	1.13	4 - 18.7	5.5 x 2.0	140 x 51	6	2.7
L1515	15	10.6	15	1.69	5 - 22.7	5.5 x 2.4	140 x 61	7.5	3.4
L1520	15	10.6	20	2.25	5 - 26.3	5.5 x 2.4	140 x 61	8	3.6
L1540	15	10.6	40	4.5	8 - 37.8	6.5 x 2.8	165 x 71	15	6.8
L2010	20	14.1	10	2	5 - 23.2	5.5 x 2.4	140 x 61	8	3.6
L2015	20	14.1	15	3	7 - 28.4	5.9 x 2.8	150 x 71	11.5	5.2
L2020	20	14.1	20	4	8 - 32.8	6.5 x 2.8	165 x 71	14	6.4
L2040	20	14.1	40	8	12 - 42.8	8.0 x 3.5	203 x 89	27	12.3
L3005	30	21.2	5	2.25	5 - 26.1	5.5 x 2.4	140 x 61	8.5	3.9
L3010	30	21.2	10	4.5	8 - 37.8	6.5 x 2.8	165 x 71	15	6.8
L3015	30	21.2	15	6.75	11 - 45.9	8.0 x 3.0	203 x 76	22	10.0
L3020	30	21.2	20	9	13 - 43.2	8.0 x 3.5	203 x 89	28	12.7
L4005	40	28.3	5	4	8 - 32	6.5 x 2.8	165 x 71	14	6.4
L4010	40	28.3	10	8	13 - 43.2	8.0 x 3.5	203 x 89	27	12.3
L4015	40	28.3	15	12	20 - 56	10 x 3.4	254 x 86	39	17.7
L5005	50	35.3	5	6.25	11 - 35	8.0 x 3.0	203 x 76	23	10.4
L5010	50	35.3	10	12.5	20 - 57.5	10.0 x 3.4	254 x 86	39	17.7
L6005	60	42.4	5	9	12 - 43.2	8.0 x 3.5	203 x 89	29	13.2



DNV Certification, Inc.

---

# DET NORSKE VERITAS QUALITY SYSTEM CERTIFICATE

---

Certificate No. 98-HOU-AQ-9211 Rev. 2

This is to certify that the Quality System  
of

## AMVECO MAGNETICS, INC.

at

10401 Westoffice Drive, Houston, TX 77042 USA

and

Libramiento Lopez Portillo No. 216, Nave 7, Saltillo, Coahuila, Mexico C.P. 25310

Has been found to conform to Quality Standard:

### ISO 9001, 1994

This Certificate is valid for the following products/service ranges:

**DESIGN AND MANUFACTURE OF TOROIDAL TRANSFORMERS,  
CHOKES, RELATED COMPONENTS AND ASSEMBLIES**

Place and date:

Houston, Texas; 29 March 1999

For the Accredited Unit:  
Det Norske Veritas Certification, Inc.  
Houston, Texas, USA  
DNV Management System Certification  
The Netherlands

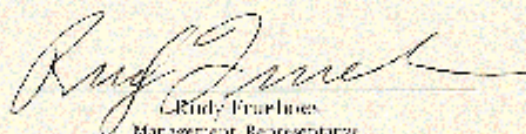

Rudy Franchini  
Management Representative  
DNV Certification, Inc.



Accredited by  
the RAB

This certificate is valid until:

27 January 2001

Issue Certification Date:

07 January 1999

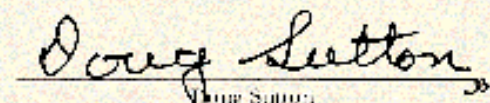

Doug Sutton  
Lead Auditor

Users of this Certificate are notified that should the Applicant be unable to comply with the conditions of this Certificate, the Applicant may render its system non-compliant.

DET NORSKE VERITAS CERTIFICATION, INC., 10500 Park Ten Place, Suite 200, Houston, TX 77036, USA TEL: (281) 721-1600 FAX: (281) 521-0500



*Corporate headquarters and main plant, Houston, TX*

