

## Features

- ◆ Glass passivated junction chip.
- ◆ For surface mounted application
- ◆ Low forward voltage drop
- ◆ Low profile package
- ◆ Built-in stain relief, ideal for automatic placement
- ◆ Fast switching for high efficiency
- ◆ High temperature soldering:  
250°C/10 seconds at terminals
- ◆ Plastic material used carries Underwriters Laboratory  
Classification 94V-O

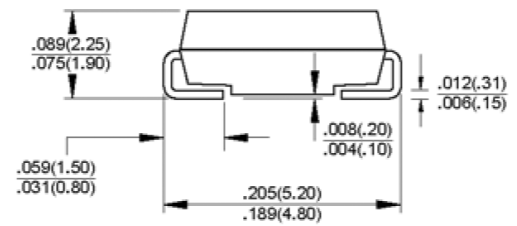

**DO-214AC (SMA)**

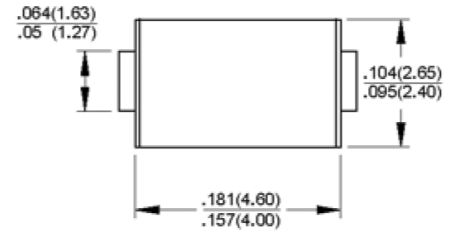

**Dimensions in inches and (millimeters)**

## Mechanical Data

- ◆ Cases: Molded plastic
- ◆ Terminals: Solder plated
- ◆ Polarity: Indicated by cathode band
- ◆ Weight: 0.002 ounce, 0.064 gram

## Maximum Ratings and Electrical Characteristics

Ratings at 25°C ambient temperature unless otherwise specified.

Single phase, half wave, 60Hz, resistive or inductive load.

For capacitive load, derate current by 20%

Parameter	Symbols	HS1A	HS1B	HS1D	HS1F	HS1G	HS1J	HS1K	HS1M	Units
Maximum repetitive peak reverse voltage	$V_{RRM}$	50	100	200	300	400	600	800	1000	Volts
Maximum RMS voltage	$V_{RMS}$	35	70	140	210	280	420	560	700	Volts
Maximum DC blocking voltage	$V_{DC}$	50	100	200	300	400	600	800	1000	Volts
Maximum average forward rectified current See Fig.2	$I_{(AV)}$	1.0								Amp
Peak forward surge current, 8.3ms single half sine-wave superimposed on rated load (JEDEC Method)	$I_{FSM}$	30.0								Amps
Maximum instantaneous forward voltage @ 1.0A	$V_F$	1.0				1.3		1.7		Volts
Maximum DC reverse current @ $T_A=25^\circ\text{C}$ at rated DC blocking voltage @ $T_A=100^\circ\text{C}$	$I_R$					5.0		100		$\mu\text{A}$ $\mu\text{A}$
Maximum reverse recovery time (Note 1)	$t_{rr}$	50						75		nS
Typical junction capacitance (Note 2)	$C_J$	20						15		pF
Operating junction temperature range	$T_J$	-55 to +150								$^\circ\text{C}$
Storage temperature range	$T_{STG}$	-55 to +150								$^\circ\text{C}$

**Notes:** 1. Reverse Recovery Test Conditions:  $I_F=0.5\text{A}$ ,  $I_R=1.0\text{A}$ ,  $I_{RR}=0.25\text{A}$   
2. Measured at 1 MHz and Applied Reverse Voltage of 4.0 V D.C.

## RATINGS AND CHARACTERISTIC CURVES

FIG.1- REVERSE RECOVERY TIME CHARACTERISTIC AND TEST CIRCUIT DIAGRAM

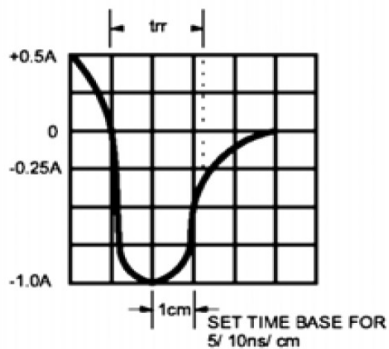
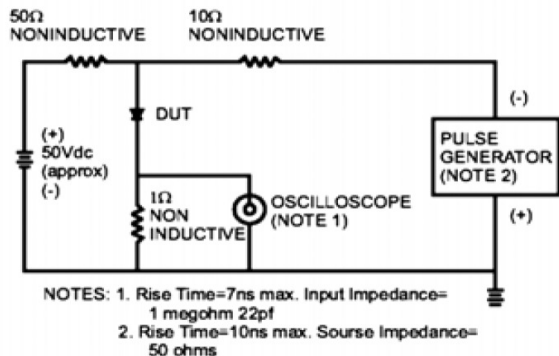

FIG.2- MAXIMUM AVERAGE FORWARD CURRENT DERATING

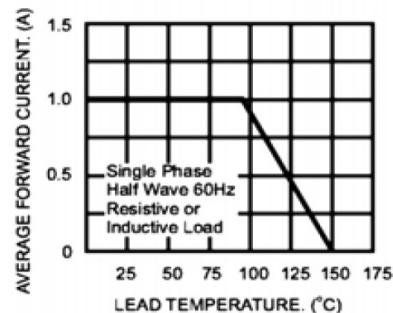

FIG.3- TYPICAL REVERSE CHARACTERISTICS

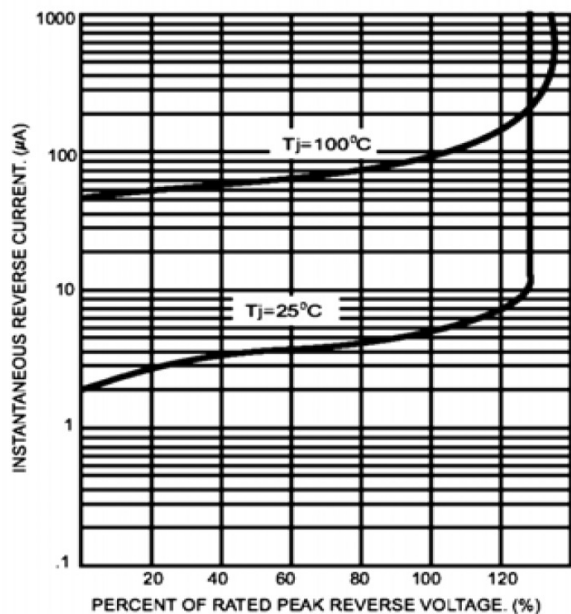

FIG.4- TYPICAL INSTANTANEOUS FORWARD CHARACTERISTICS

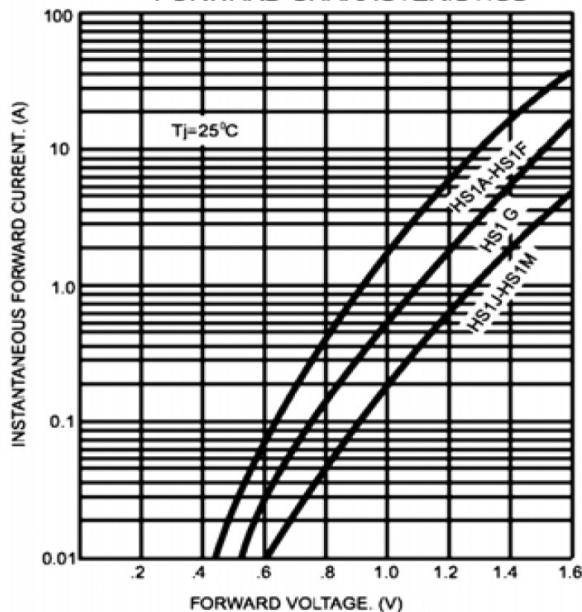

FIG.5- MAXIMUM NON-REPETITIVE FORWARD SURGE CURRENT

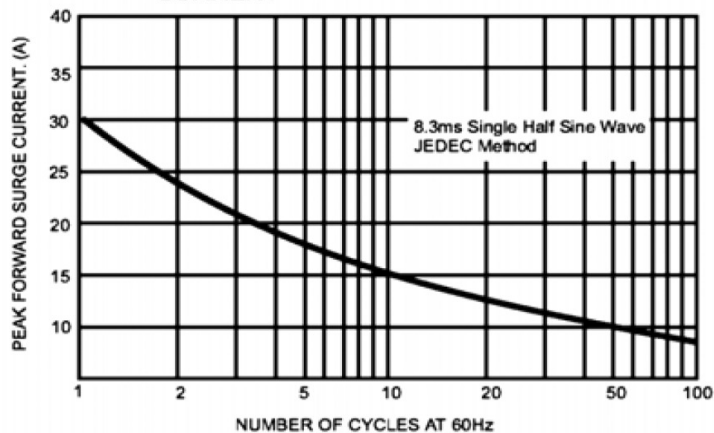

FIG.6- TYPICAL JUNCTION CAPACITANCE

