

DKSV271

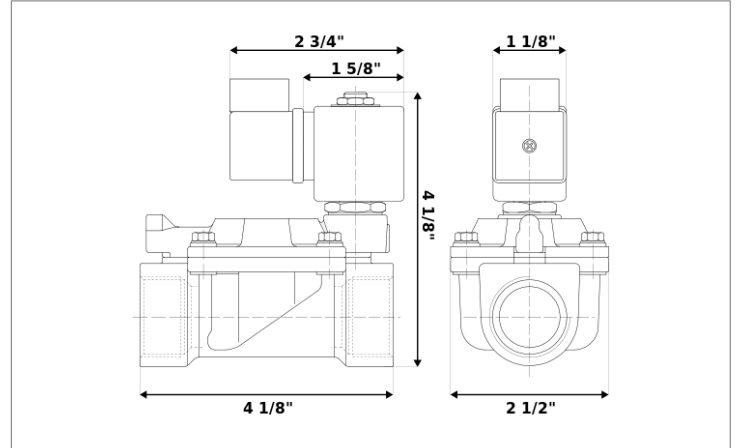

Normally closed, pilot operated, 2-way solenoid valve with low lead brass body and 3/4" connections



Valve	
Pipe size:	3/4" NPT
Pressure:	3-230 psi
Flow coefficient:	9.8 Cv
Media temperature:	15-280 °F
Ambient temperature:	15-105 °F
Suggested usage:	Potable water
Operation:	2-way, normally closed solenoid valve
Mechanism:	Pilot operated
Manual override:	No
Pipe gender:	Female
Orifice size:	3/4"

Electrical	
Power:	12 V dc
Coil wattage:	8 W
Wire connection:	Conduit connector
Cable entry:	1/2" NPT
Consumption:	0.67 A
Tolerances:	+10% -5%
Coil inner diameter:	1/2"
Coil molding:	Polyamide (PA)
Coil rating:	15-310 °F (Class F)
Duty cycle:	Continuous, 100% ED
Enclosure:	NEMA 4, IP65

Materials	
Body:	Low lead brass
Seal:	EPDM rubber (EPDM)
Orifice:	Low lead brass
Armature tube:	Stainless steel 300
Fixed core:	Stainless steel 400
Plunger:	Stainless steel 400
Spring:	Stainless steel 300
Shading ring:	Copper

Spare parts		
ARMATURE TUBE	REPAIR KIT	COIL/CONNECTOR
AT-N0E1	RK-W0E2-02	C-D41
		
<ul style="list-style-type: none"> • Armature tube • Plunger • O-ring 	<ul style="list-style-type: none"> • Diaphragm • O-rings (2) • Plunger 	<ul style="list-style-type: none"> • 12 V dc electrical coil • 1/2" conduit connector