



NT1191GEAE3S

GNSS Wideband Low Noise Amplifier

FEATURES

- Frequency range: 1164 MHz to 1610 MHz
- Supply voltage: 1.5 V to 5.5 V (3.3 V typ.)
- Current consumption: 5.5 mA typ.
- Gain: 17.5 dB typ. @ L1/2/5/6 band
- NF: 0.75 dB typ. @ L1/2/5/6 band
- P-1dB(IN): -10 dBm typ. @ L1/2/5/6 band
- IIP3: 0 dBm typ. @ L1/2/5/6 band
- With stand-by function
- Package size: 1.6 x 1.6 x 0.78 mm typ.
- RoHS compliant and Halogen Free, MSL1

APPLICATIONS

- GNSS (GPS, GLONASS, Galileo, BeiDou, etc.) receiver application
- Multi-GNSS application for high-precision positioning
- Active antenna, car navigation, dashboard camera, GNSS tracker, drone

GENERAL DESCRIPTION

The NT1191 is a GNSS wideband low noise amplifier (LNA) designed for multi-GNSS receiver applications.

This LNA features good gain flatness and low noise figure (NF) in the entire GNSS band from 1164 MHz to 1610 MHz. It supports a wide range of supply voltage from 1.5 V to 5.5 V. The stand-by function contributes to reduce current consumption. Integrated ESD protection device on each port is achieved excellent ESD robustness. The wide operating temperature range from -40 to +105 °C.

Only one external input matching inductor is required. The package is 1.6 x 1.6 mm in size with wettable flank, and corresponds to automated optical inspection (AOI).



DFN1616-6-GE
1.6 x 1.6 x 0.78 (mm)

BLOCK DIAGRAM

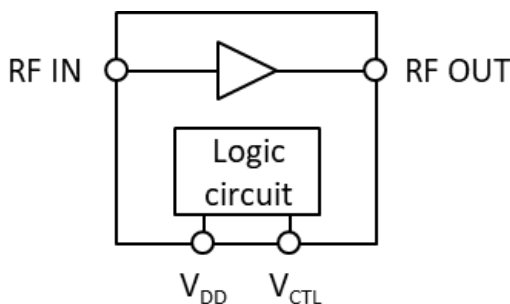

■ PRODUCT NAME INFORMATION

NT1191 GE A E3 S

Description of configuration

Suffix	Item	Description
GE	Package code	Indicates the package. Refer to the order information.
A	Version	Indicates the product version. "A" is initial version.
E3	Packing	Refer to the packing specifications.
S	Grade	Indicates the quality grade. "S" means general-purpose and consumer application. Operating temperature range: -40°C to +105°C, Test temperature: +25°C

■ ORDER INFORMATION

PRODUCT NAME	PACKAGE	RoHS	HALOGEN-FREE	PLATING COMPOSITION	MARKING	WEIGHT (mg)	Quantity per Reel (pcs)
NT1191GEAE3S	DFN1616-6-GE	Yes	Yes	SnBi	1191	5.4	3000

■ PIN DESCRIPTIONS

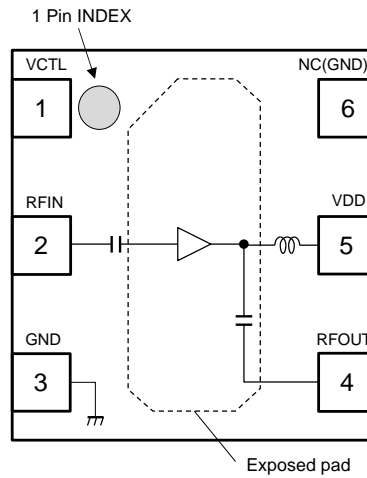

DFN1616-6-GE Pin Configuration

Pin No.	Pin Name	Description
1	VCTL	Control signal input terminal
2	RFIN	RF input terminal
3	GND	Ground terminal
4	RFOUT	RF output terminal
5	VDD	Operating voltage supply terminal
6	NC(GND)	No connected terminal (connect to ground)
-	Exposed pad	Ground terminal

Please refer to "APPLICATION CIRCUIT" for details.

■ TRUTH TABLE

"H"= $V_{CTL}(H)$, "L"= $V_{CTL}(L)$

V_{CTL}	Mode
H	Active mode
L	Stand-by mode

■ ABSOLUTE MAXIMUM RATINGS

General conditions: $T_a = +25^{\circ}\text{C}$, $Z_s = Z_l = 50\Omega$

Parameter	Symbol	Ratings	Unit
Supply Voltage	V_{DD}	6.0	V
Control Voltage	V_{CTL}	6.0	V
Input Power	P_{IN}^{*1}	+15	dBm
Power Dissipation	P_D^{*2}	1100	mW
Operating Temperature Range	T_{opr}	-40 to +105	$^{\circ}\text{C}$
Storage Temperature Range	T_{stg}	-55 to +150	$^{\circ}\text{C}$

*1 $V_{DD} = 3.3\text{ V}$

*2 4-layer FR4 PCB with through-hole (101.5 x 114.5 mm), $T_j = 150^{\circ}\text{C}$

ABSOLUTE MAXIMUM RATINGS

Electronic and mechanical stress momentarily exceeded absolute maximum ratings may cause permanent damage and may degrade the lifetime and safety for both device and system using the device in the field. The functional operation at or over these absolute maximum ratings is not assured.

■ THERMAL CHARACTERISTICS

Parameter	Value
Thermal Resistance (θ_{ja})	$\theta_{ja} = 116^{\circ}\text{C/W}$
Thermal Characterization Parameter (ψ_{jt})	$\psi_{jt} = 43^{\circ}\text{C/W}$

θ_{ja} : Junction-to-Ambient Thermal Resistance

ψ_{jt} : Junction-to-Top Thermal Characterization Parameter

■ ELECTROSTATIC DISCHARGE (ESD) PROTECTION VOLTAGE

Symbol	Conditions	Protection Voltage
HBM	$C = 100\text{ pF}$, $R = 1.5\text{ k}\Omega$	$\pm 2000\text{ V}$
CDM	Direct CDM	$\pm 1000\text{ V}$

ESD PROTECTION VOLTAGE

The electrostatic discharge test is done based on JEITA ED-4701.
In the HBM method, ESD is applied using the GND pin as reference pins.

■ RECOMMENDED OPERATING CONDITIONS

Parameter	Symbol	Value	Unit
Supply Voltage	V_{DD}	1.5 to 5.5	V
Control Voltage	V_{CTL}	1.5 to 5.5	V
Operating Temperature Range	T_a	-40 to +105	°C

RECOMMENDED OPERATING CONDITIONS

All of electronic equipment should be designed that the mounted semiconductor devices operate within the recommended operating conditions. The semiconductor devices cannot operate normally over the recommended operating conditions, even if when they are used over such conditions by momentary electronic noise or surge. And the semiconductor devices may receive serious damage when they continue to operate over the recommended operating conditions.

■ ELECTRICAL CHARACTERISTICS 1 (DC)

General conditions: $T_a = +25^{\circ}\text{C}$, $Z_s = Z_l = 50\Omega$

Parameter	Symbol	Conditions	MIN	TYP	MAX	Unit
Supply Voltage	V_{DD}		1.5	3.3	5.5	V
Control Voltage (High)	$V_{CTL(H)}$		1.5	1.8	5.5	V
Control Voltage (Low)	$V_{CTL(L)}$		0	0	0.3	V
Operating Current	I_{DD}	RF OFF, $V_{DD} = 3.3\text{ V}$, $V_{CTL} = 1.8\text{ V}$	-	5.5	8.0	mA
		RF OFF, $V_{DD} = 1.8\text{ V}$, $V_{CTL} = 1.8\text{ V}$	-	3.5	-	
		RF OFF, $V_{DD} = 3.3\text{ V}$, $V_{CTL} = 0\text{ V}$	-	0.1	3.0	μA
		RF OFF, $V_{DD} = 1.8\text{ V}$, $V_{CTL} = 0\text{ V}$	-	0.1	-	
Control Current	I_{CTL}	RF OFF, $V_{CTL} = 1.8\text{ V}$	-	5	20	μA

■ ELECTRICAL CHARACTERISTICS 2 (RF)

General conditions: $V_{DD} = 3.3\text{ V}$, $V_{CTL} = 1.8\text{ V}$, $f = 1164\text{ MHz to }1610\text{ MHz}$, $T_a = +25^\circ\text{C}$, $Z_s = Z_l = 50\Omega$, with application circuit

Parameter	Symbol	Conditions	MIN	TYP	MAX	Unit
Small Signal Gain	Gain	f = 1176 MHz (L5 band), Exclude PCB, connector loss ^{*3}	15.0	17.5	19.0	dB
		f = 1227 MHz (L2 band), Exclude PCB, connector loss ^{*3}				
		f = 1278 MHz (L6 band), Exclude PCB, connector loss ^{*3}				
		f = 1575 MHz (L1 band), Exclude PCB, connector loss ^{*3}				
Noise Figure	NF	f = 1176 MHz (L5 band), Exclude PCB, connector loss ^{*4}	-	0.75	1.1	dB
		f = 1227 MHz (L2 band), Exclude PCB, connector loss ^{*4}				
		f = 1278 MHz (L6 band), Exclude PCB, connector loss ^{*4}				
		f = 1575 MHz (L1 band), Exclude PCB, connector loss ^{*4}				
Isolation	ISL	f = 1176 MHz (L5 band)	32	35	-	dB
		f = 1227 MHz (L2 band)				
		f = 1278 MHz (L6 band)				
		f = 1575 MHz (L1 band)				
Input Power at 1 dB Gain Compression Point	P-1dB(IN)	f = 1176 MHz (L5 band)	-15.0	-10.0	-	dBm
		f = 1227 MHz (L2 band)				
		f = 1278 MHz (L6 band)				
		f = 1575 MHz (L1 band)				
Input 3rd Order Intercept Point	IIP3	f1 = 1176 MHz, f2 = f1 + 1 MHz, Pin = -30 dBm	-5.0	0	-	dBm
		f1 = 1227 MHz, f2 = f1 + 1 MHz, Pin = -30 dBm				
		f1 = 1278 MHz, f2 = f1 + 1 MHz, Pin = -30 dBm				
		f1 = 1575 MHz, f2 = f1 + 1 MHz, Pin = -30 dBm				
RF IN Return Loss	RLi	f = 1176 MHz (L5 band)	6.0	12.0	-	dB
		f = 1227 MHz (L2 band)				
		f = 1278 MHz (L6 band)				
		f = 1575 MHz (L1 band)				
RF OUT Return Loss	RLo	f = 1176 MHz (L5 band)	10.0	18.0	-	dB
		f = 1227 MHz (L2 band)				
		f = 1278 MHz (L6 band)				
		f = 1575 MHz (L1 band)				
k factor	k	f = 50 MHz to 10 GHz	1.0	-	-	-

^{*3} PCB and connector losses of input and output: 0.09 dB (1176 MHz), 0.10 dB (1227 MHz), 0.11 dB (1278 MHz), 0.14 dB (1575 MHz)

^{*4} PCB and connector losses of input: 0.04 dB (1176 MHz, 1227 MHz), 0.05 dB (1278 MHz), 0.06 dB (1575 MHz)

■ ELECTRICAL CHARACTERISTICS 3 (RF)

General conditions: $V_{DD} = 1.8\text{ V}$, $V_{CTL} = 1.8\text{ V}$, $f = 1164\text{ MHz to }1610\text{ MHz}$, $T_a = +25^\circ\text{C}$, $Z_s = Z_l = 50\Omega$, with application circuit

Parameter	Symbol	Conditions	MIN	TYP	MAX	Unit
Small Signal Gain	Gain	f = 1176 MHz (L5 band), Exclude PCB, connector loss ^{*3}	-	16.0	-	dB
		f = 1227 MHz (L2 band), Exclude PCB, connector loss ^{*3}				
		f = 1278 MHz (L6 band), Exclude PCB, connector loss ^{*3}				
		f = 1575 MHz (L1 band), Exclude PCB, connector loss ^{*3}				
Noise Figure	NF	f = 1176 MHz (L5 band), Exclude PCB, connector loss ^{*4}	-	0.85	-	dB
		f = 1227 MHz (L2 band), Exclude PCB, connector loss ^{*4}				
		f = 1278 MHz (L6 band), Exclude PCB, connector loss ^{*4}				
		f = 1575 MHz (L1 band), Exclude PCB, connector loss ^{*4}				
Isolation	ISL	f = 1176 MHz (L5 band)	-	34	-	dB
		f = 1227 MHz (L2 band)				
		f = 1278 MHz (L6 band)				
		f = 1575 MHz (L1 band)				
Input Power at 1 dB Gain Compression Point	P-1dB(IN)	f = 1176 MHz (L5 band)	-	-16.0	-	dBm
		f = 1227 MHz (L2 band)				
		f = 1278 MHz (L6 band)				
		f = 1575 MHz (L1 band)				
Input 3rd Order Intercept Point	IIP3	f1 = 1176 MHz, f2 = f1 + 1 MHz, Pin = -30 dBm	-	-6.0	-	dBm
		f1 = 1227 MHz, f2 = f1 + 1 MHz, Pin = -30 dBm				
		f1 = 1278 MHz, f2 = f1 + 1 MHz, Pin = -30 dBm				
		f1 = 1575 MHz, f2 = f1 + 1 MHz, Pin = -30 dBm				
RF IN Return Loss	RLi	f = 1176 MHz (L5 band)	-	10.0	-	dB
		f = 1227 MHz (L2 band)				
		f = 1278 MHz (L6 band)				
		f = 1575 MHz (L1 band)				
RF OUT Return Loss	RLo	f = 1176 MHz (L5 band)	-	15.0	-	dB
		f = 1227 MHz (L2 band)				
		f = 1278 MHz (L6 band)				
		f = 1575 MHz (L1 band)				
k factor	k	f = 50 MHz to 10 GHz	1.0	-	-	-

^{*3} PCB and connector losses of input and output: 0.09 dB (1176 MHz), 0.10 dB (1227 MHz), 0.11 dB (1278 MHz), 0.14 dB (1575 MHz)

^{*4} PCB and connector losses of input: 0.04 dB (1176 MHz, 1227 MHz), 0.05 dB (1278 MHz), 0.06 dB (1575 MHz)

■ TYPICAL CHARACTERISTICS

Conditions: $V_{DD} = 3.3\text{ V}$, $V_{CTL} = 1.8\text{ V}$, $T_a = +25^\circ\text{C}$, $Z_s = Z_l = 50\Omega$, with application circuit
(Typical characteristics are intended to be used as reference data, they are not guaranteed.)

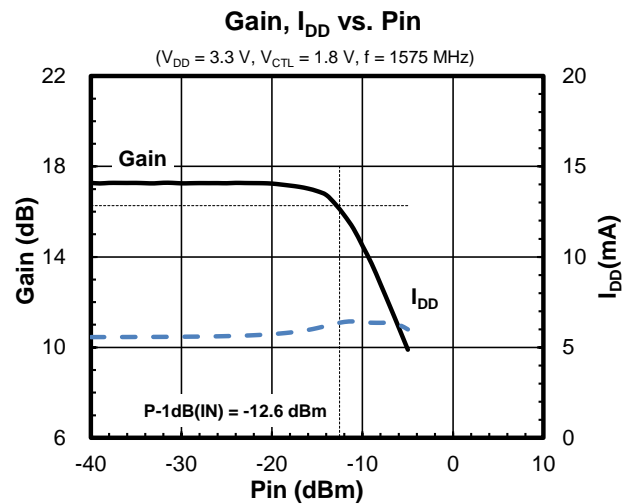
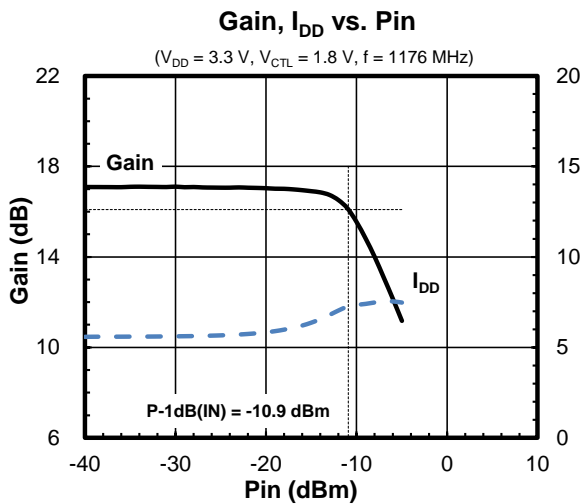
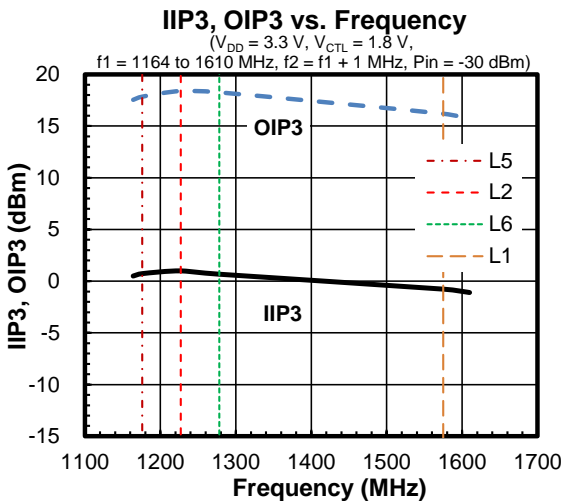
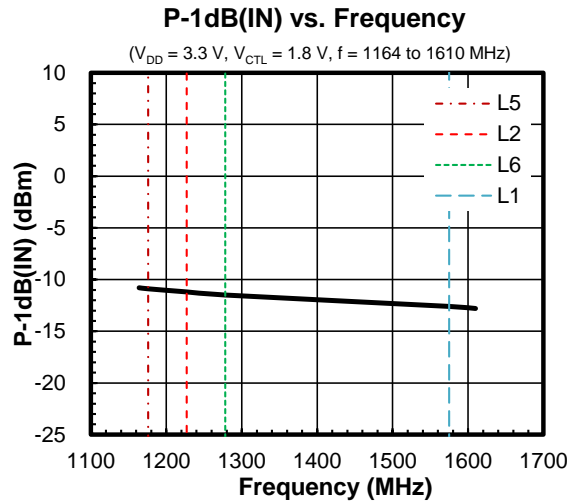
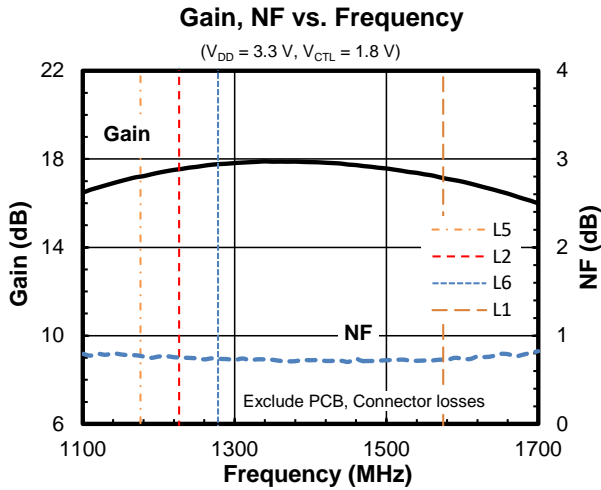

■ TYPICAL CHARACTERISTICS

Conditions: $V_{DD} = 3.3\text{ V}$, $V_{CTL} = 1.8\text{ V}$, $T_a = +25^\circ\text{C}$, $Z_s = Z_l = 50\Omega$, with application circuit
(Typical characteristics are intended to be used as reference data, they are not guaranteed.)

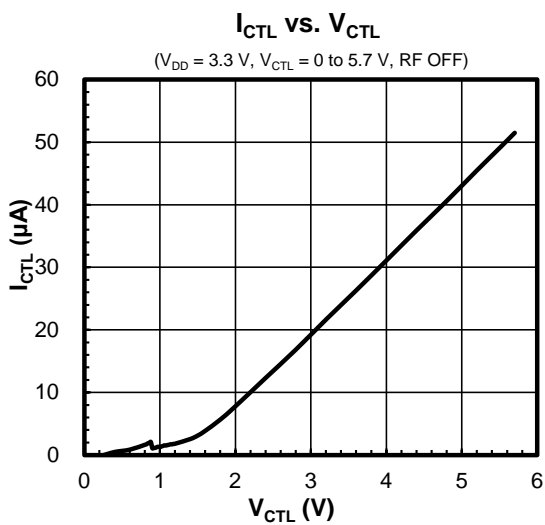
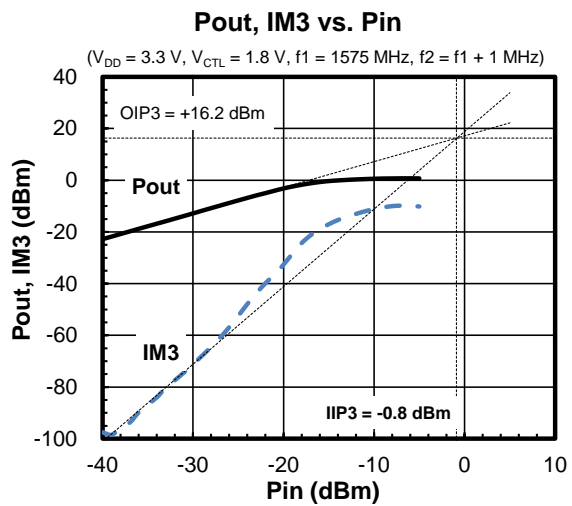
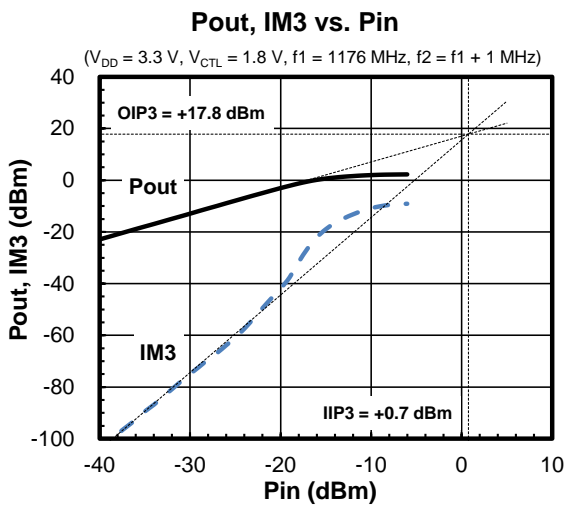
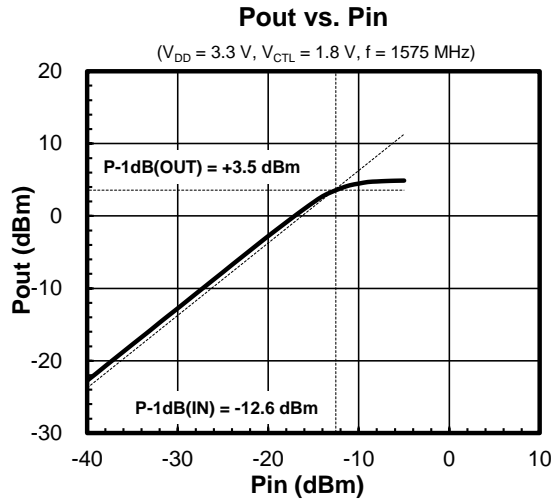
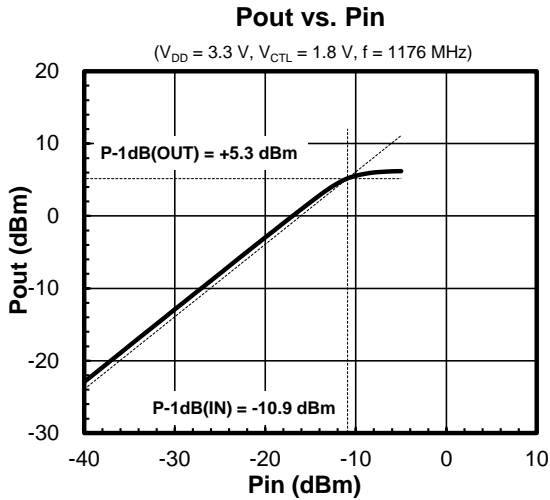

■ TYPICAL CHARACTERISTICS

Conditions: $V_{DD} = 3.3\text{ V}$, $V_{CTL} = 1.8\text{ V}$, $f = 50\text{ MHz to }3\text{ GHz}$, $T_a = +25^\circ\text{C}$, $Z_s = Z_l = 50\Omega$, with application circuit
 (Typical characteristics are intended to be used as reference data, they are not guaranteed.)

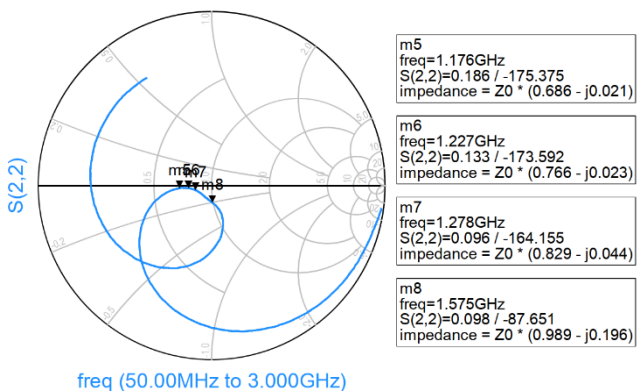
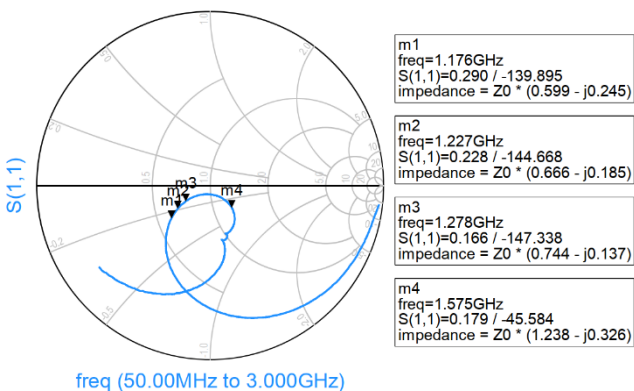
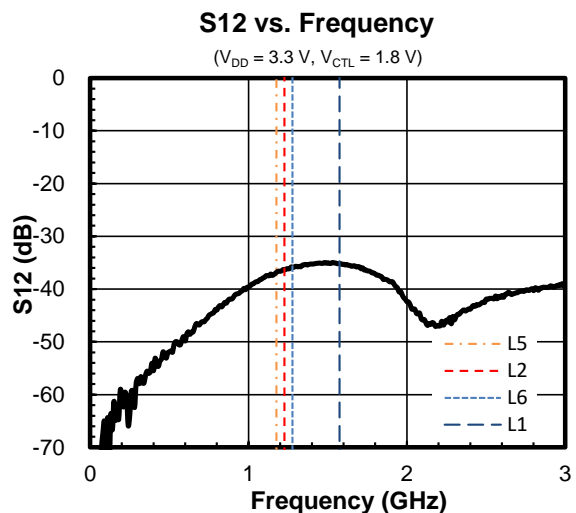
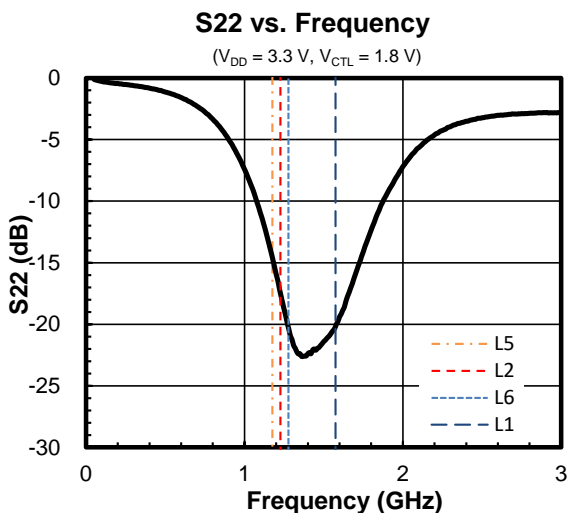
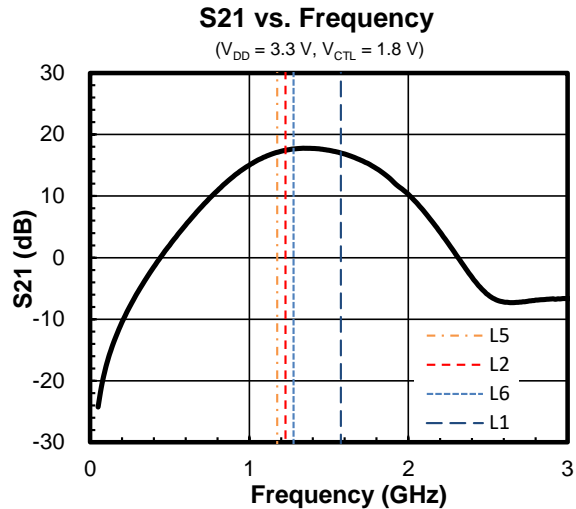
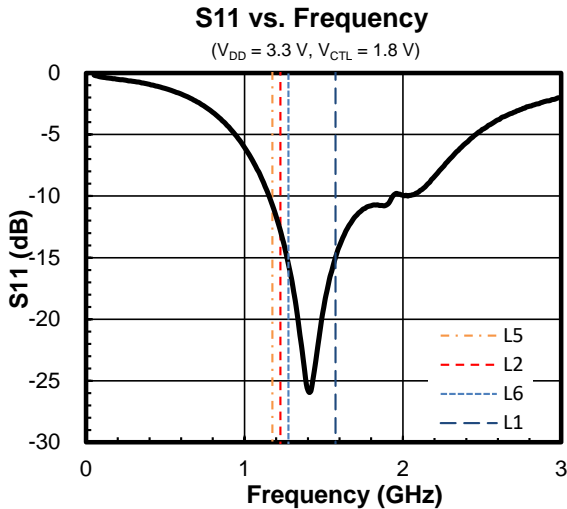

■ TYPICAL CHARACTERISTICS

Conditions: $V_{DD} = 3.3\text{ V}$, $V_{CTL} = 1.8\text{ V}$, $f = 50\text{ MHz}$ to 20 GHz , $T_a = +25^\circ\text{C}$, $Z_s = Z_l = 50\Omega$, with application circuit
 (Typical characteristics are intended to be used as reference data, they are not guaranteed.)

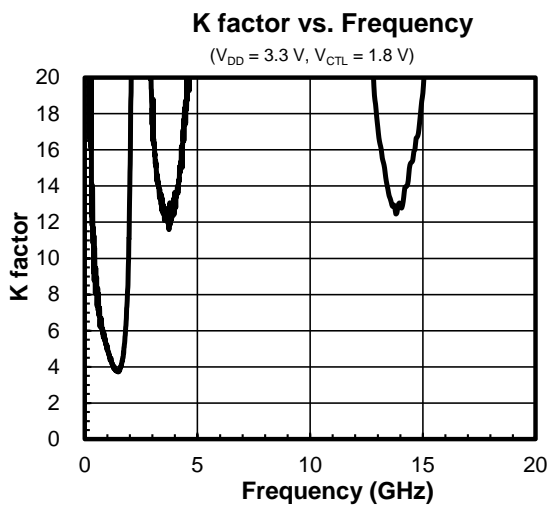
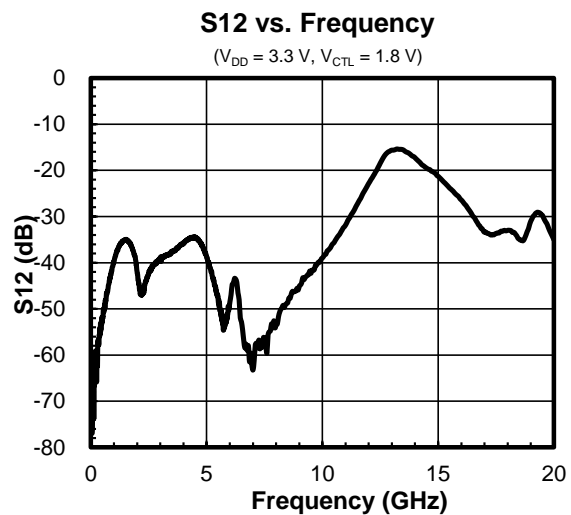
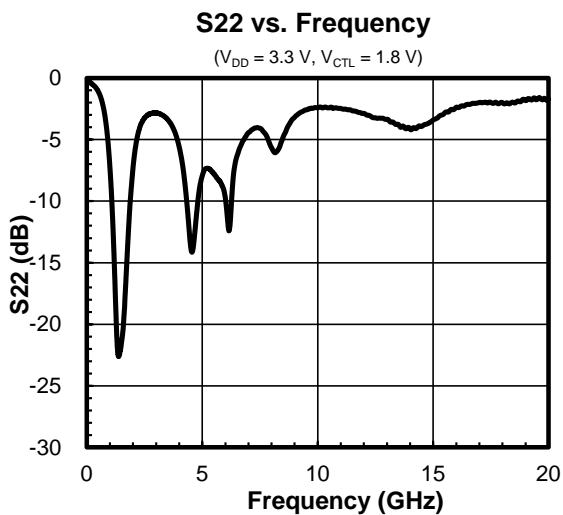
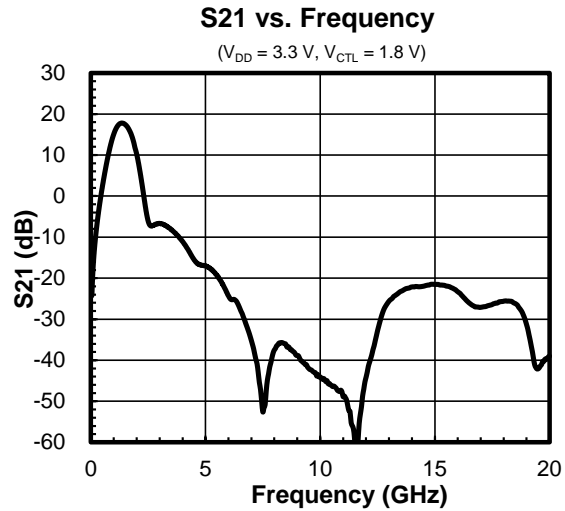
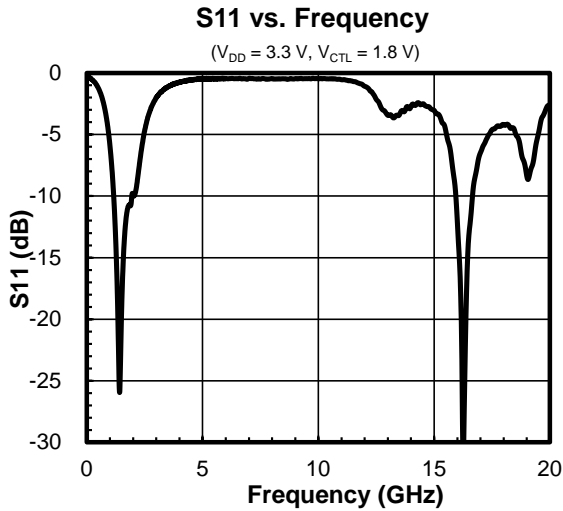

■ TYPICAL CHARACTERISTICS

Conditions: $V_{DD} = 1.8\text{ V}$, $V_{CTL} = 1.8\text{ V}$, $T_a = +25^\circ\text{C}$, $Z_s = Z_l = 50\Omega$, with application circuit
(Typical characteristics are intended to be used as reference data, they are not guaranteed.)

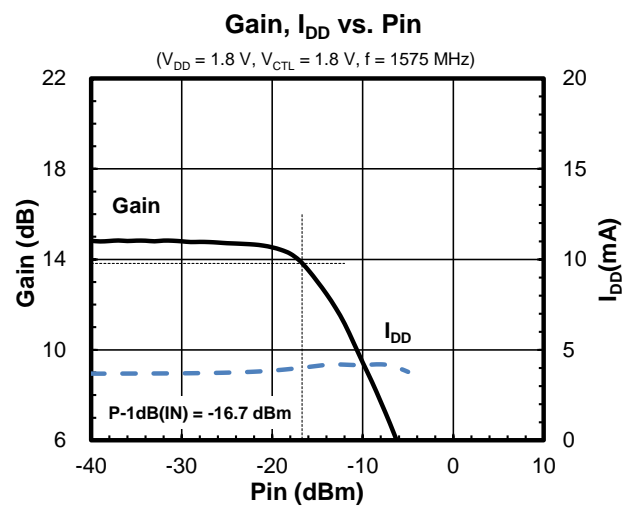
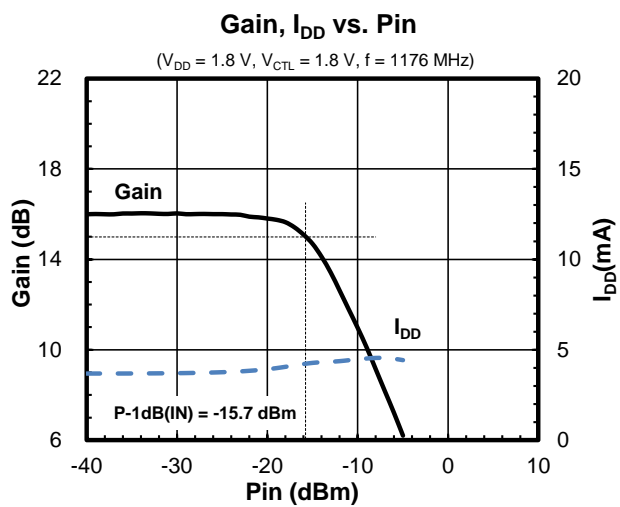
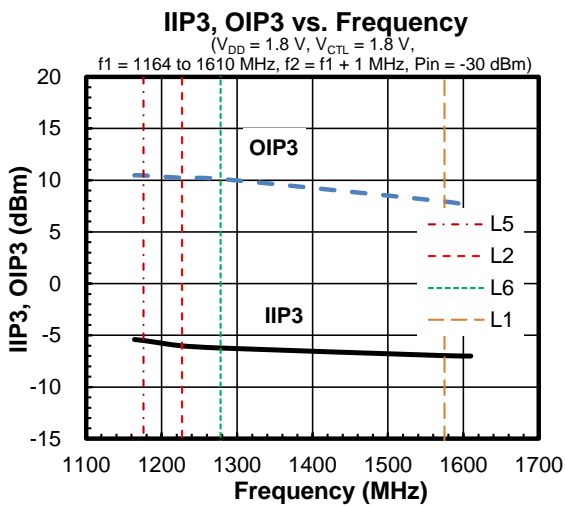
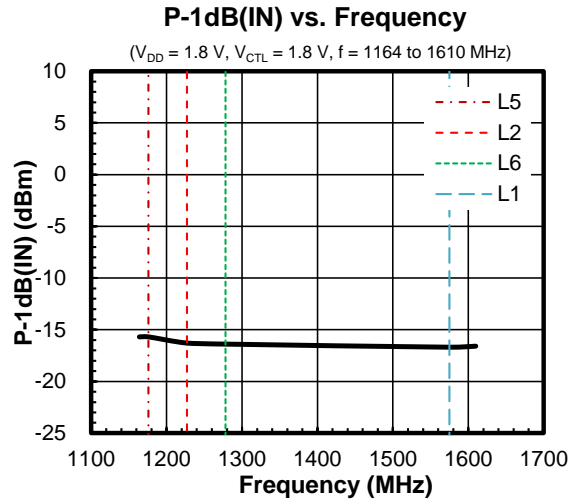
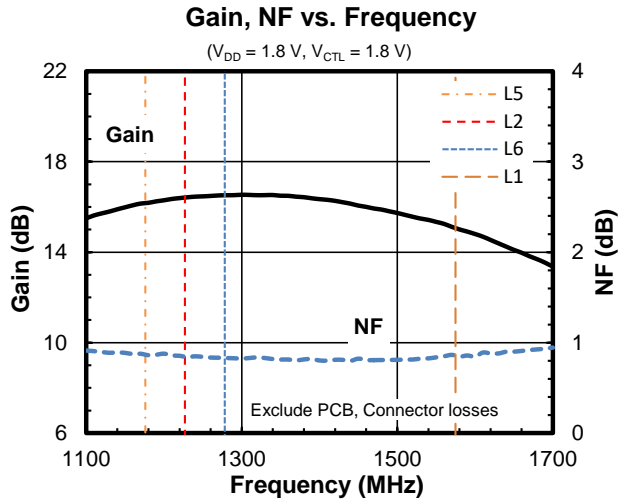

■ TYPICAL CHARACTERISTICS

Conditions: $V_{DD} = 1.8\text{ V}$, $V_{CTL} = 1.8\text{ V}$, $T_a = +25^\circ\text{C}$, $Z_s = Z_l = 50\Omega$, with application circuit
(Typical characteristics are intended to be used as reference data, they are not guaranteed.)

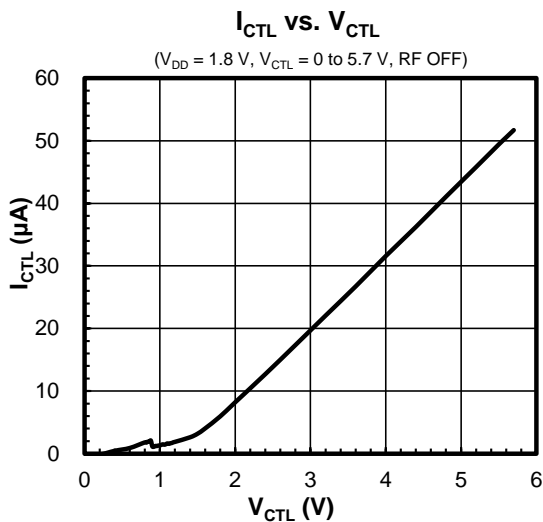
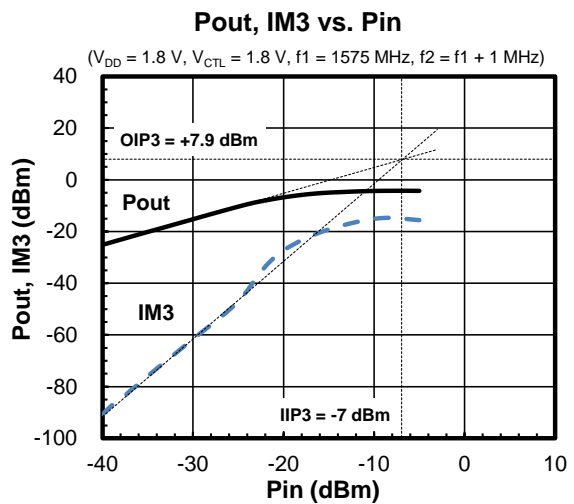
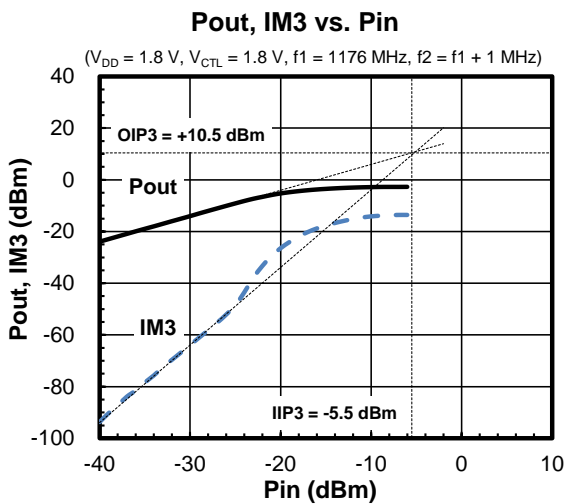
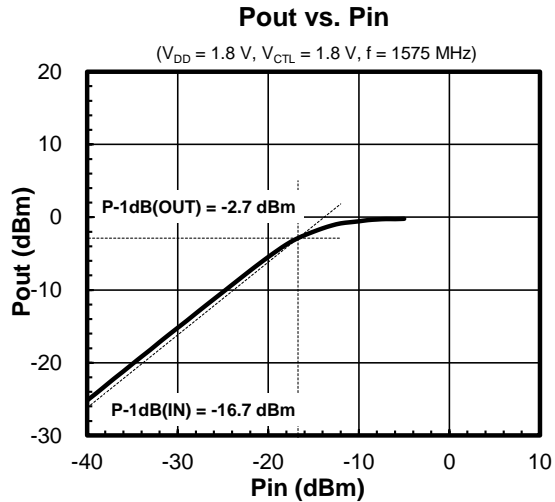
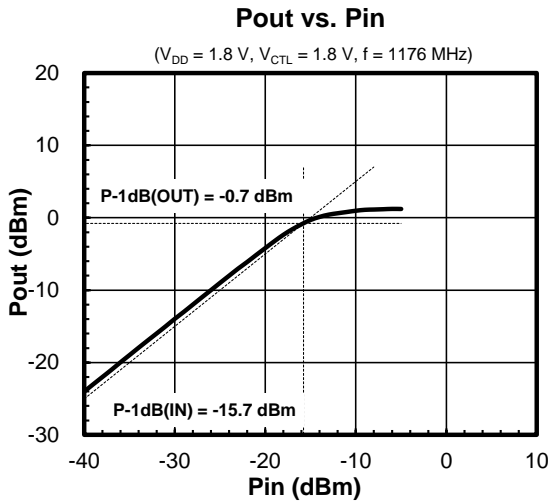

■ TYPICAL CHARACTERISTICS

Conditions: $V_{DD} = 1.8\text{ V}$, $V_{CTL} = 1.8\text{ V}$, $f = 50\text{ MHz to }3\text{ GHz}$, $T_a = +25^\circ\text{C}$, $Z_s = Z_l = 50\Omega$, with application circuit
 (Typical characteristics are intended to be used as reference data, they are not guaranteed.)

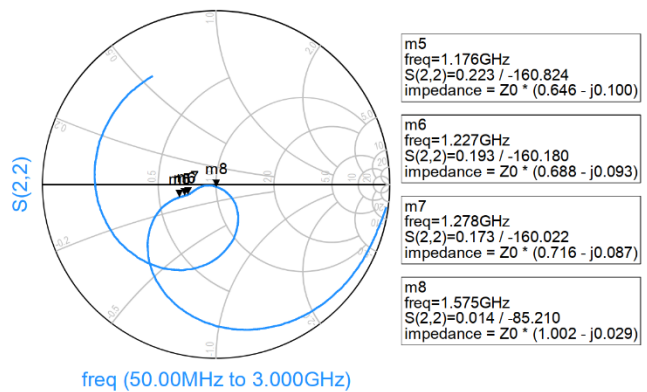
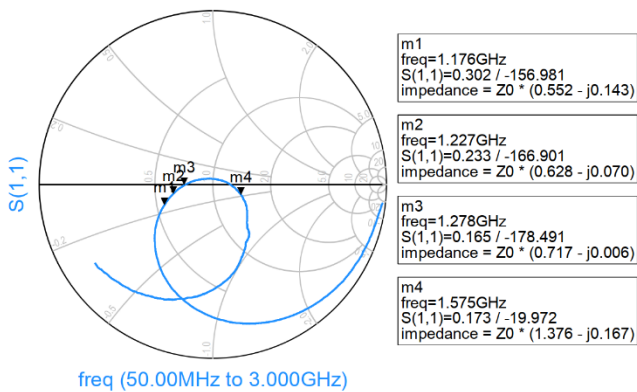
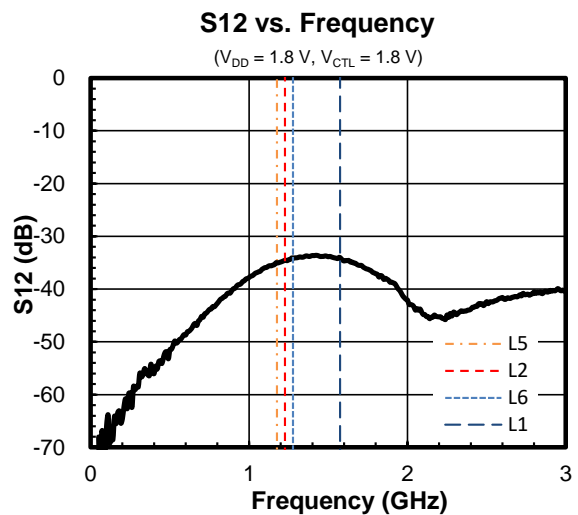
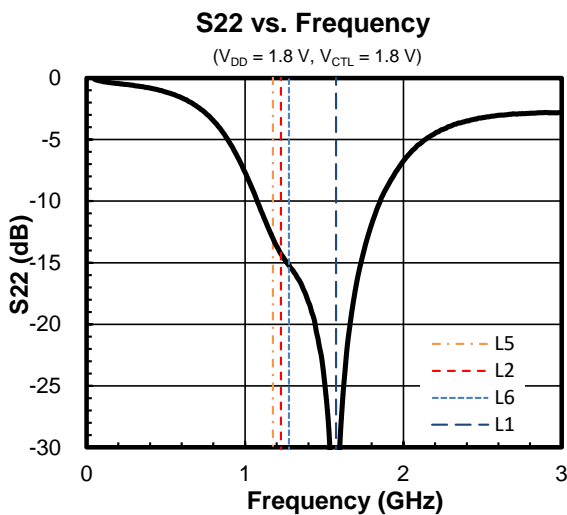
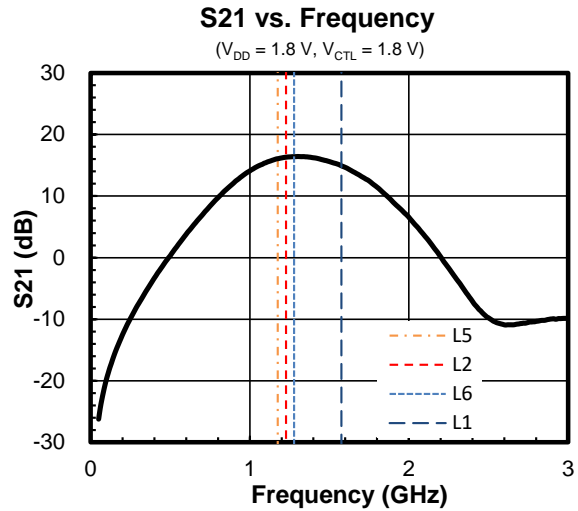
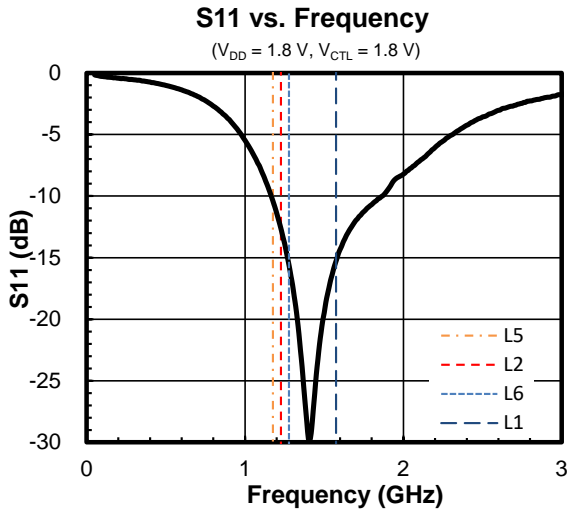

■ TYPICAL CHARACTERISTICS

Conditions: $V_{DD} = 1.8\text{ V}$, $V_{CTL} = 1.8\text{ V}$, $f = 50\text{ MHz}$ to 20 GHz , $T_a = +25^\circ\text{C}$, $Z_s = Z_l = 50\Omega$, with application circuit
(Typical characteristics are intended to be used as reference data, they are not guaranteed.)

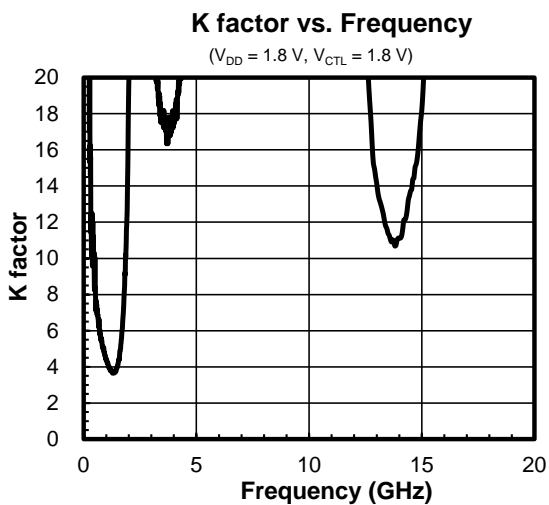
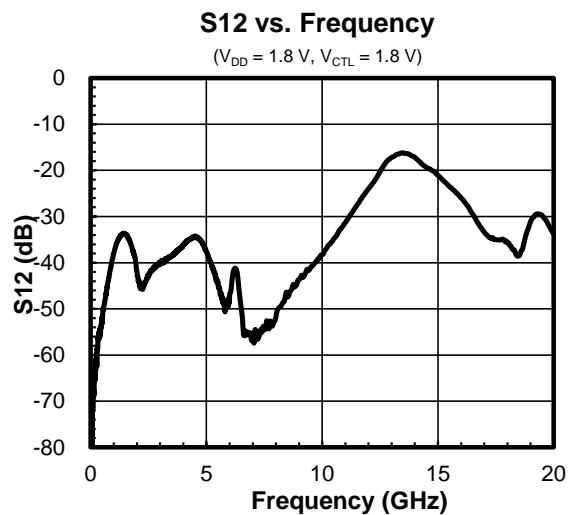
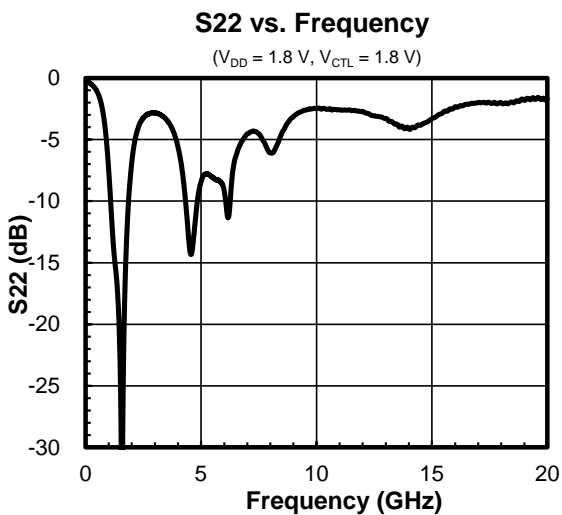
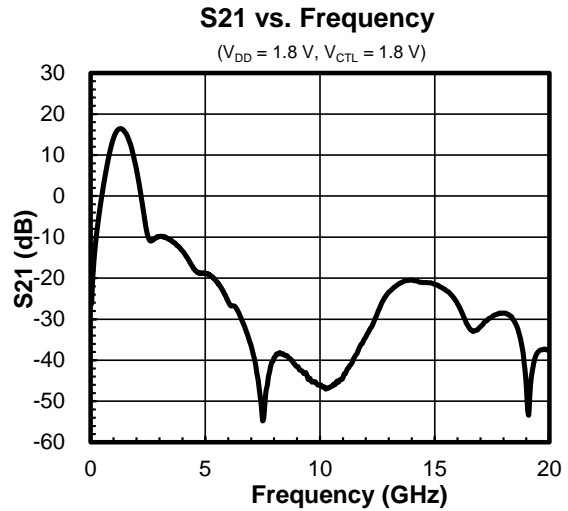
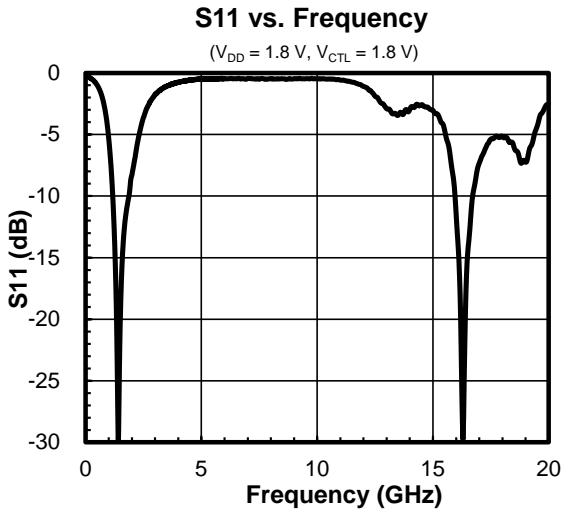

■ TYPICAL CHARACTERISTICS

Conditions: $V_{CTL} = 1.8\text{ V}$, $T_a = +25^\circ\text{C}$, $Z_s = Z_l = 50\Omega$, with application circuit
 (Typical characteristics are intended to be used as reference data, they are not guaranteed.)

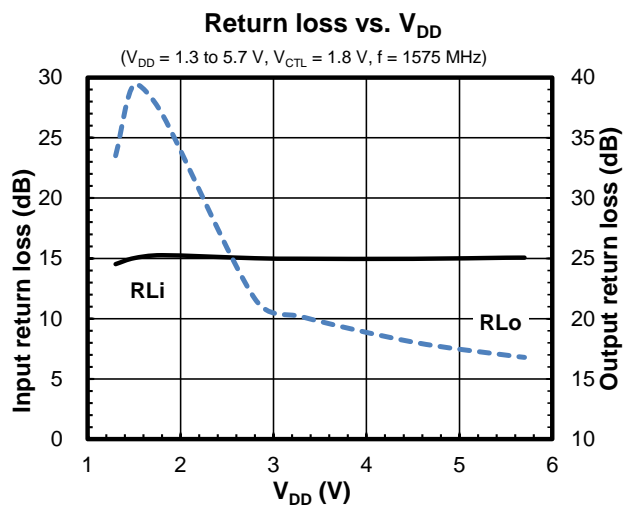
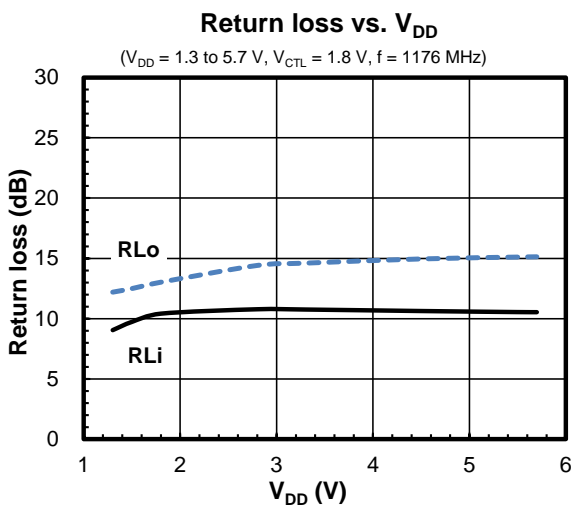
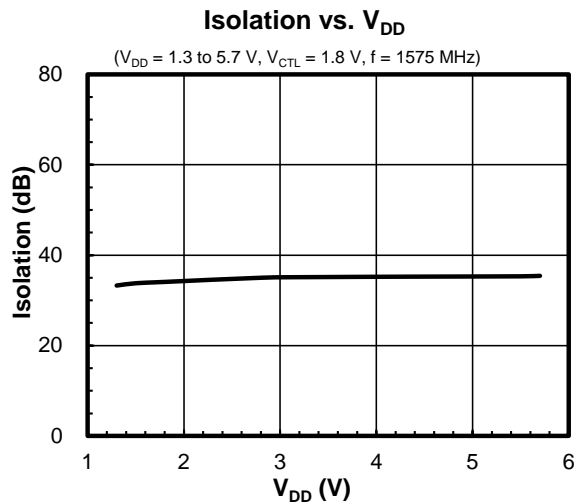
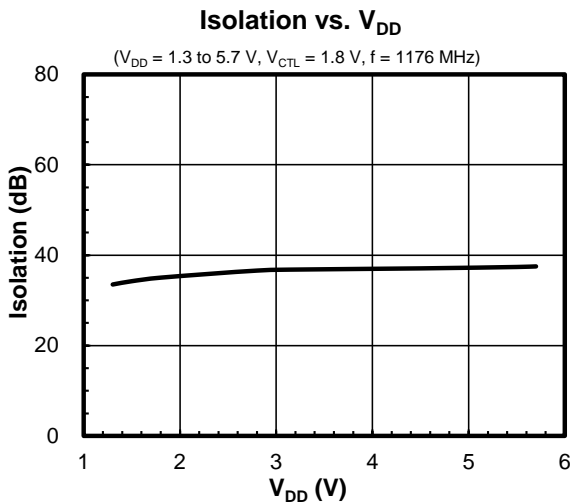
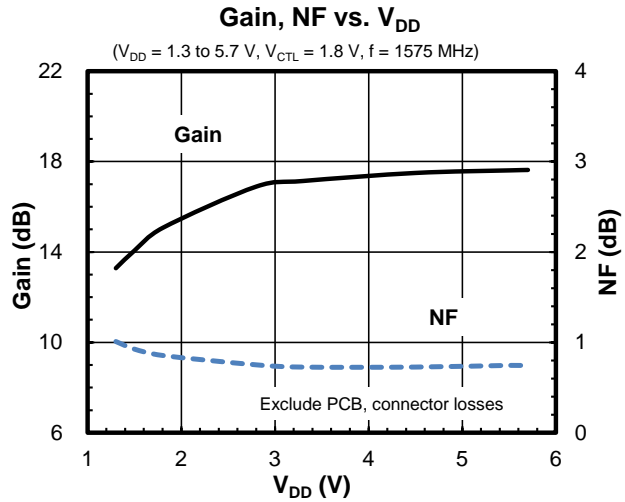
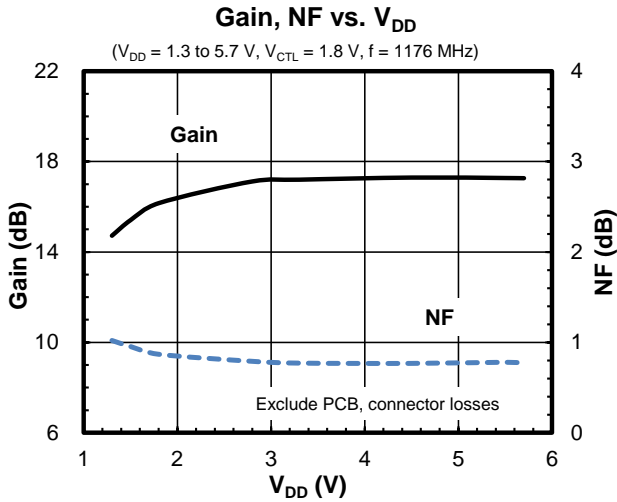

■ TYPICAL CHARACTERISTICS

Conditions: $V_{CTL} = 1.8\text{ V}$, $T_a = +25^\circ\text{C}$, $Z_s = Z_l = 50\Omega$, with application circuit
 (Typical characteristics are intended to be used as reference data, they are not guaranteed.)

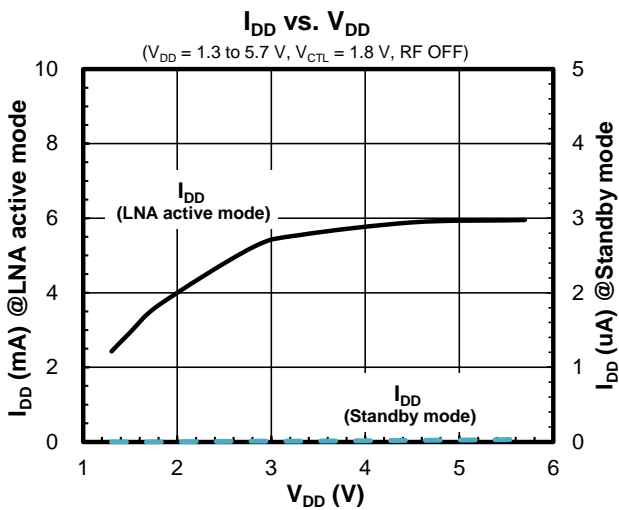
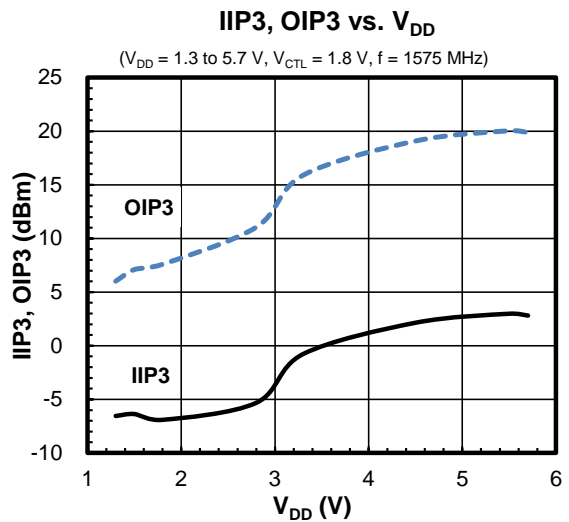
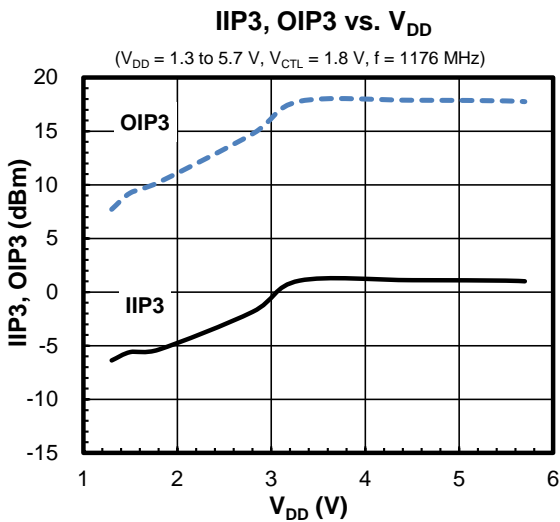
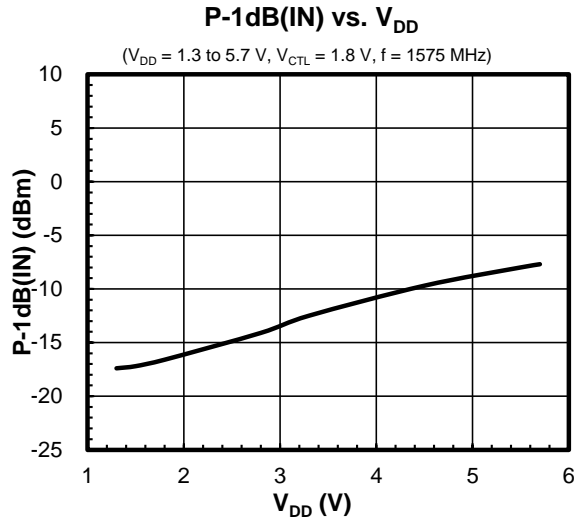
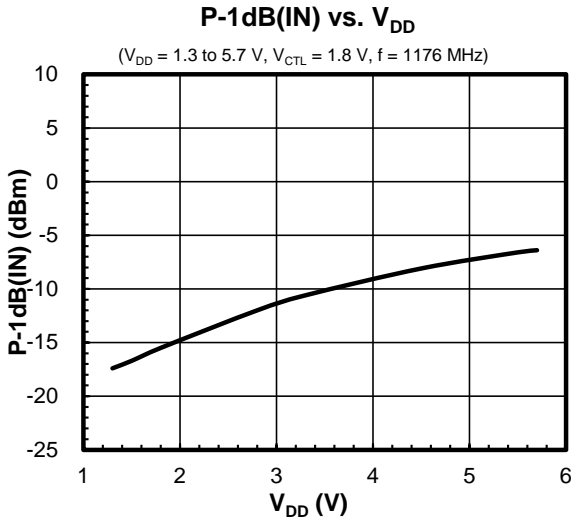

■ TYPICAL CHARACTERISTICS

Conditions: $V_{DD} = 3.3\text{ V}$, $V_{CTL} = 1.8\text{ V}$, $Z_s = Z_l = 50\Omega$, with application circuit
 (Typical characteristics are intended to be used as reference data, they are not guaranteed.)

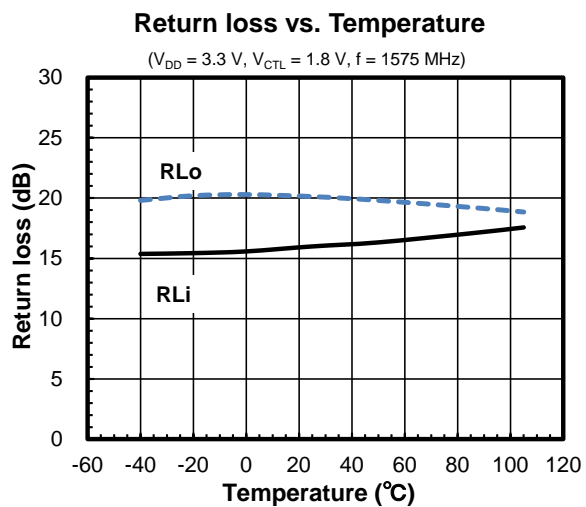
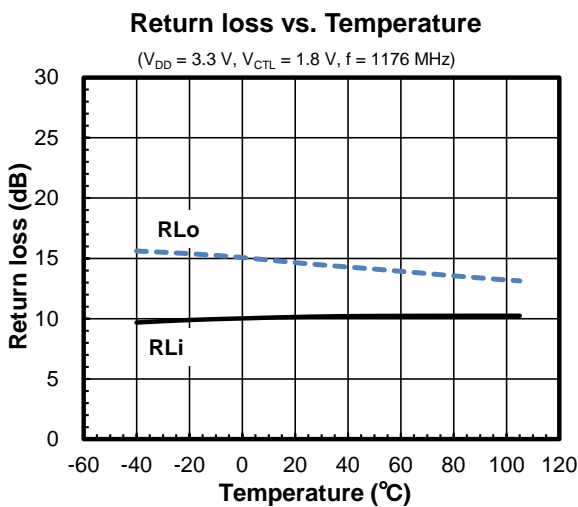
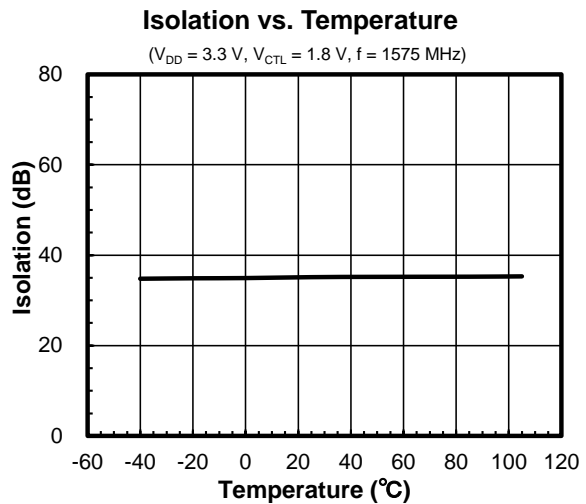
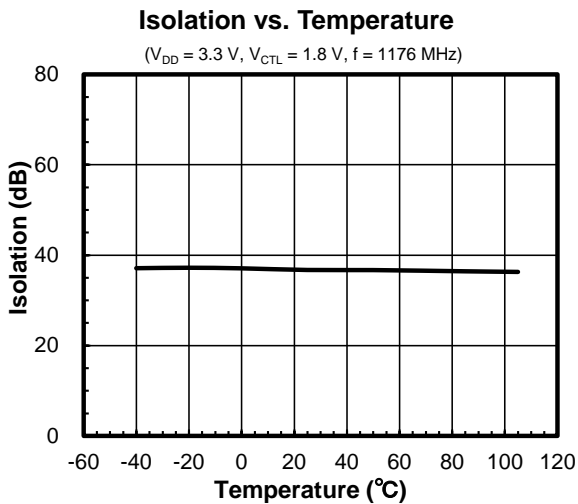
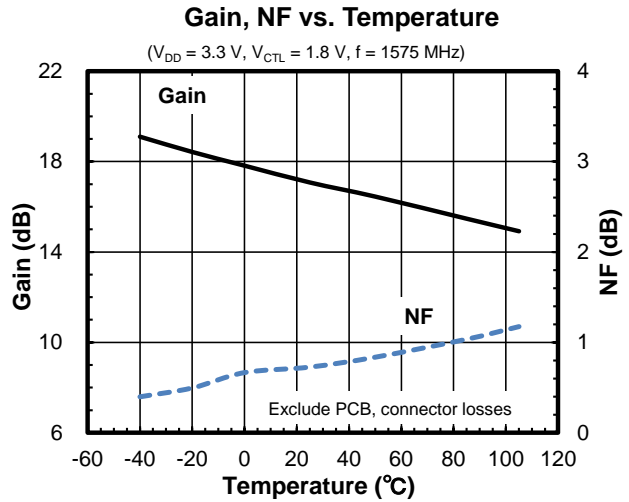
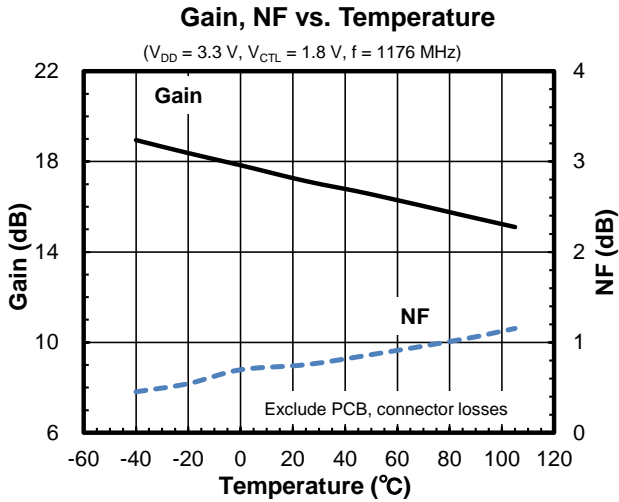

■ TYPICAL CHARACTERISTICS

Conditions: $V_{DD} = 3.3\text{ V}$, $V_{CTL} = 1.8\text{ V}$, $Z_s = Z_l = 50\Omega$, with application circuit
 (Typical characteristics are intended to be used as reference data, they are not guaranteed.)

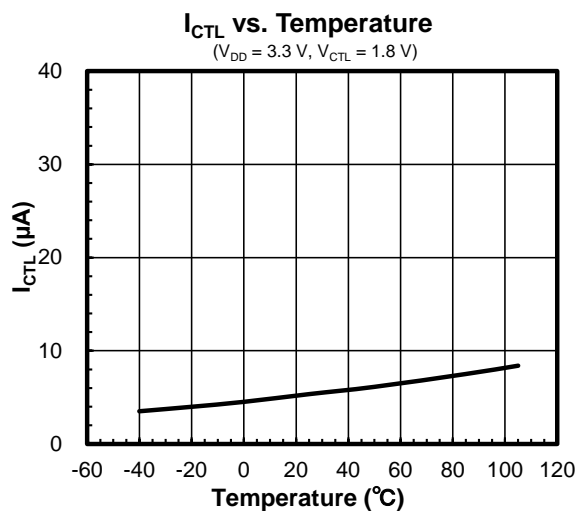
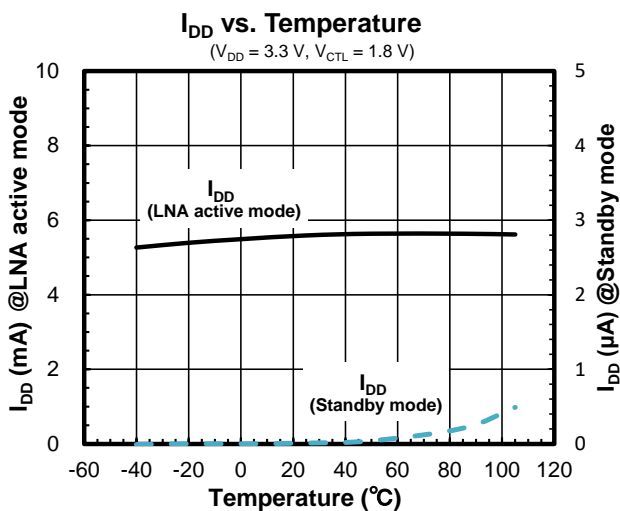
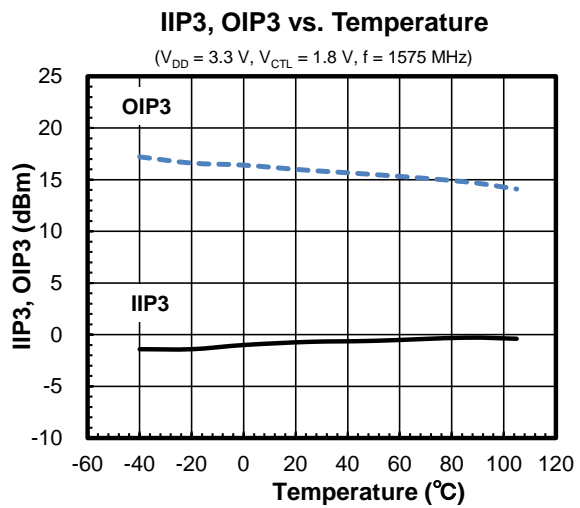
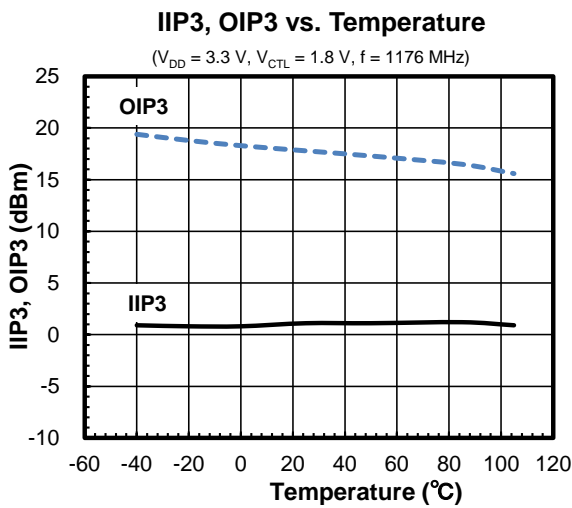
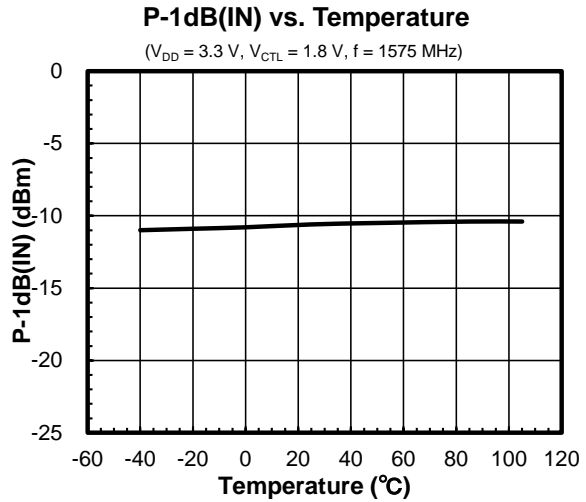
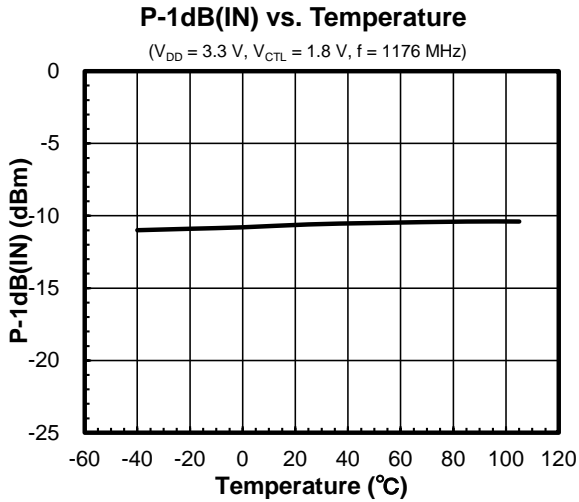

■ TYPICAL CHARACTERISTICS

Conditions: $V_{DD} = 1.8\text{ V}$, $V_{CTL} = 1.8\text{ V}$, $Z_s = Z_l = 50\Omega$, with application circuit
 (Typical characteristics are intended to be used as reference data, they are not guaranteed.)

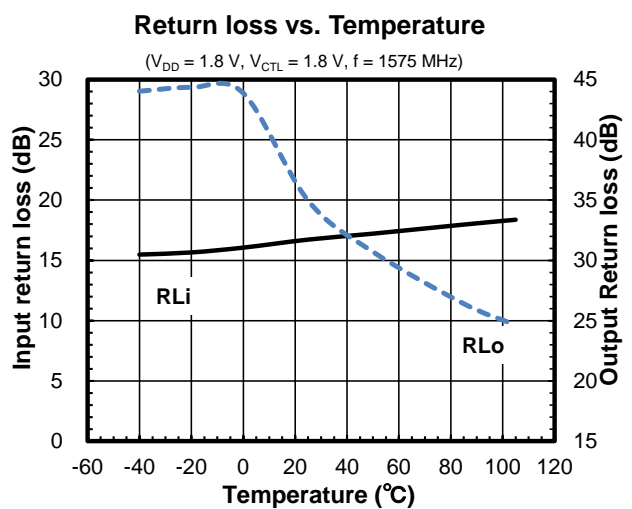
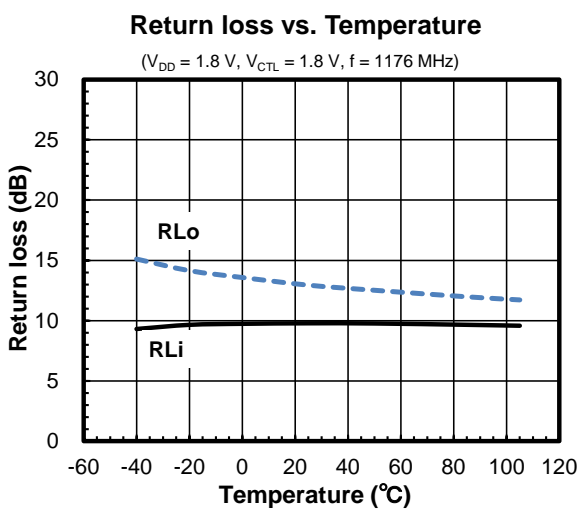
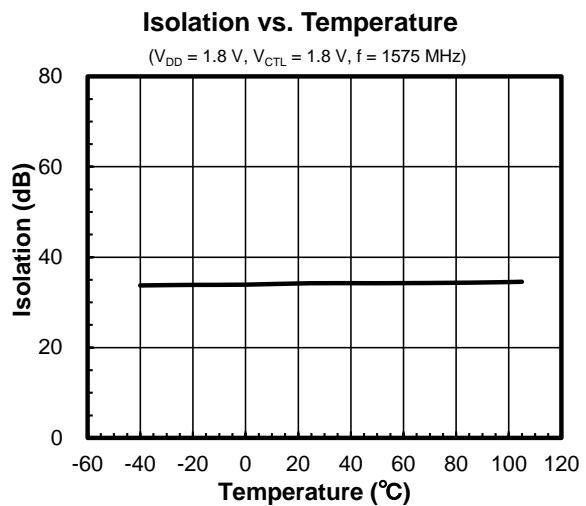
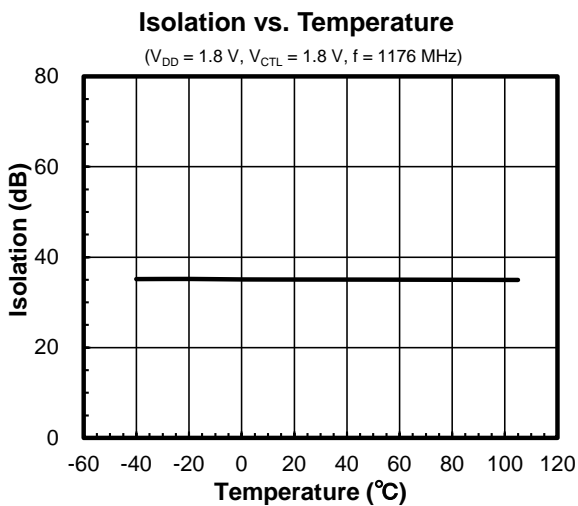
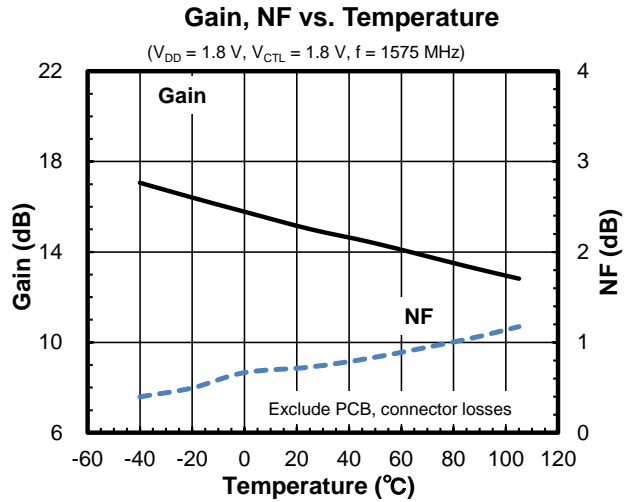
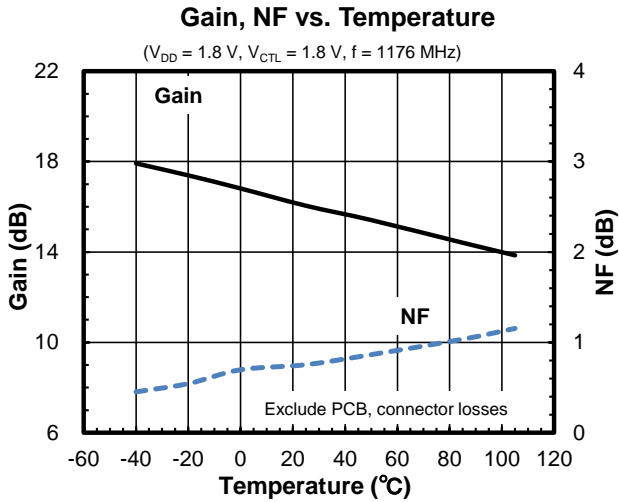

■ TYPICAL CHARACTERISTICS

Conditions: $V_{DD} = 1.8\text{ V}$, $V_{CTL} = 1.8\text{ V}$, $Z_s = Z_l = 50\Omega$, with application circuit
 (Typical characteristics are intended to be used as reference data, they are not guaranteed.)

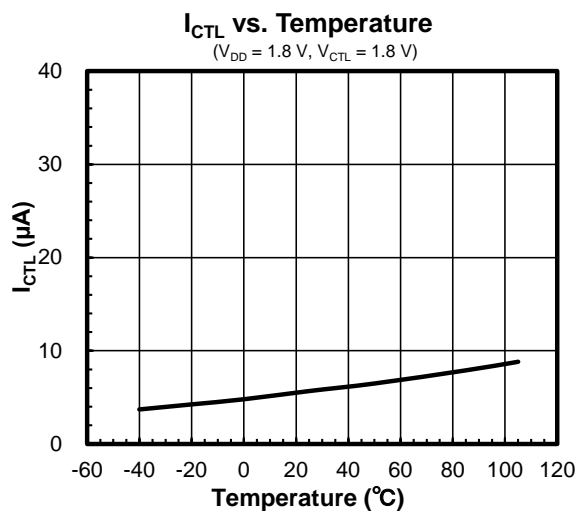
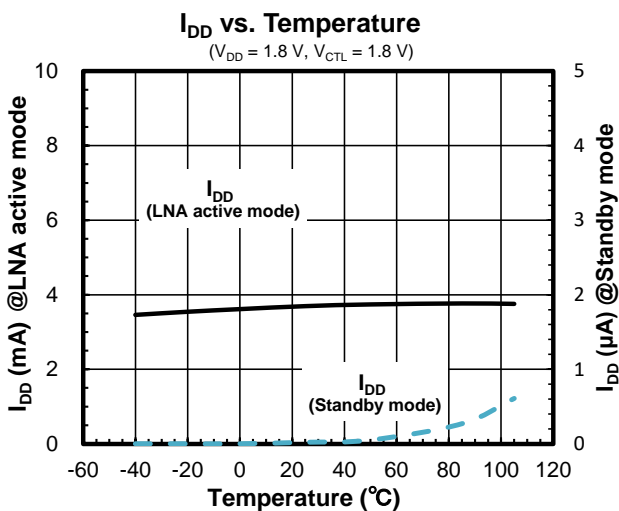
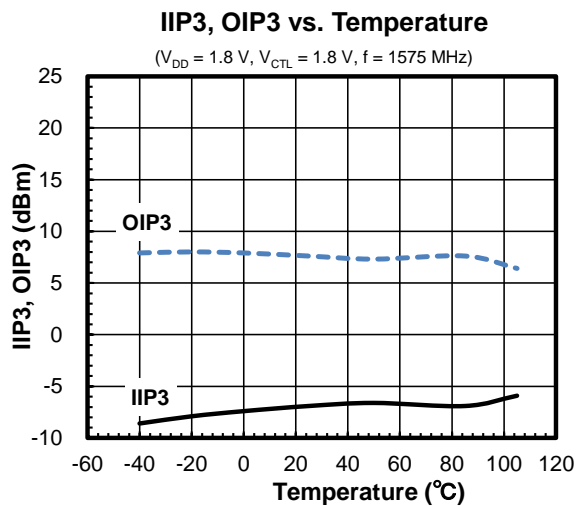
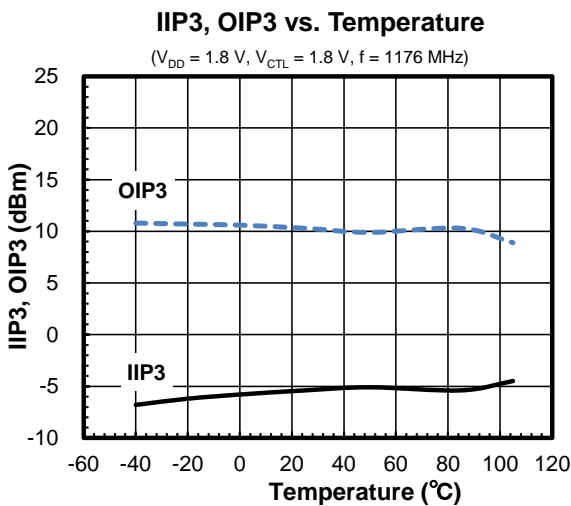
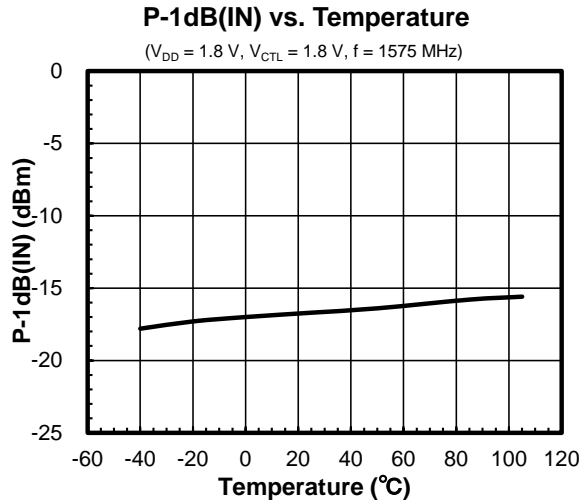
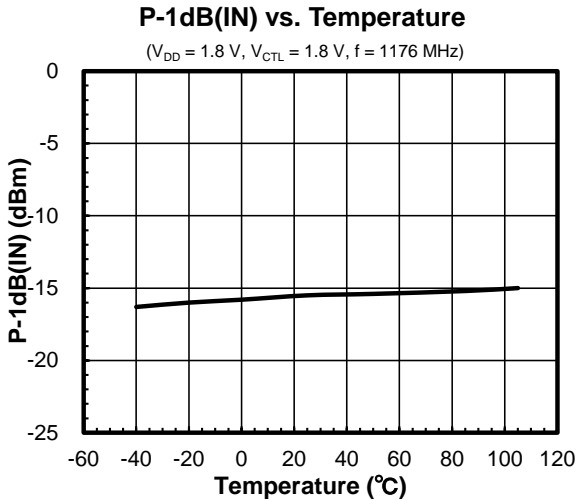

■ APPLICATION CIRCUIT

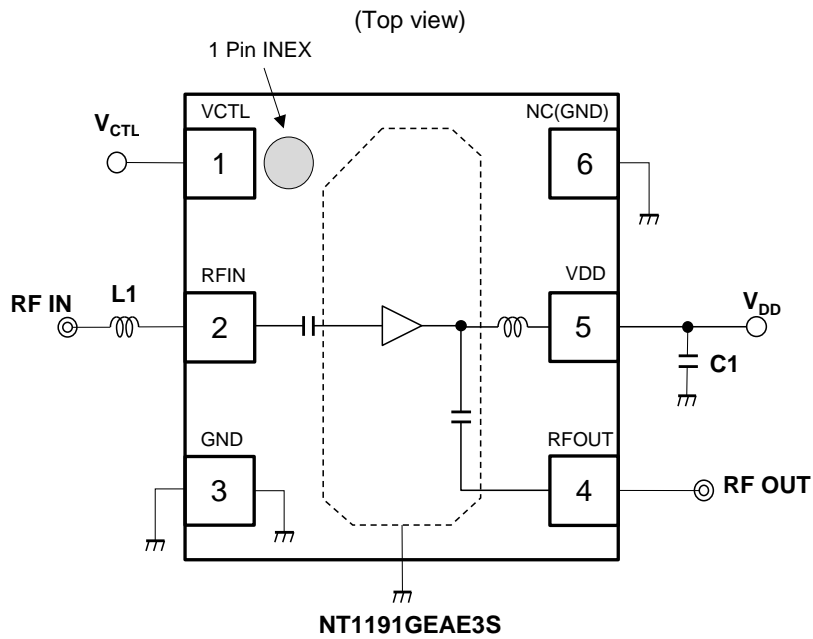

<Parts list>

Part ID	Value	Notes
L1	9.5 nH	LQW15AN_00 series (MURATA)
C1	1000 pF	GRM03 series (MURATA)

■ APPLICATION NOTES



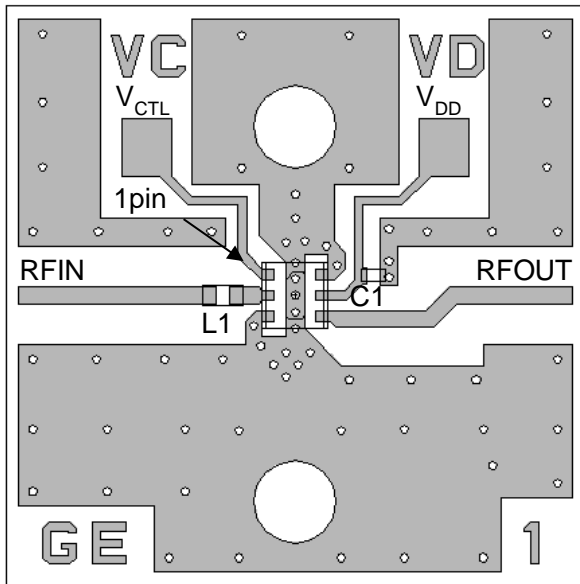

● Evaluation Board / PCB layout

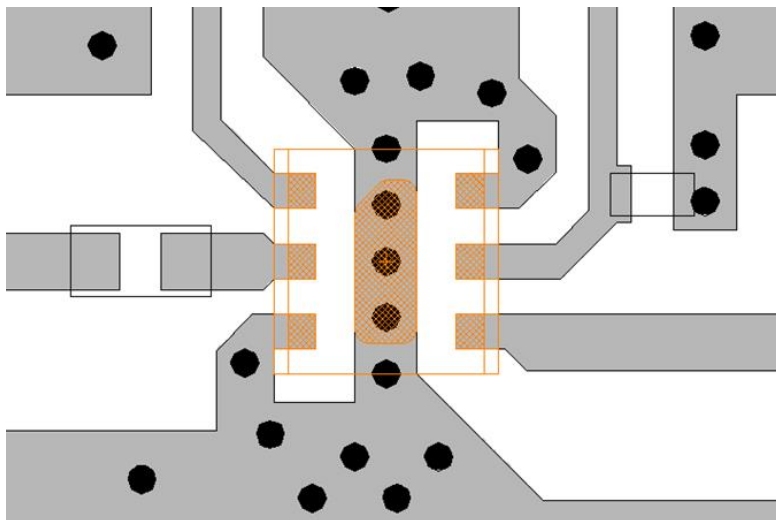

PCB
 Substrate: FR-4
 Thickness: 0.2 mm
 Microstrip line width: 0.4 mm ($Z_0 = 50\Omega$)
 Size: 14.0 x 14.0 mm

<PCB layout guideline>



-  PCB
-  PKG Terminal
-  PKG Outline
-  GND Via Hole
Diameter $\phi = 0.2$ mm

PRECAUTIONS

- All external parts should be placed as close as possible to the LNA.
- For good RF performance, all GND terminals must be connected to PCB ground plane of substrate, and via-holes for GND should be placed near the LNA.

● NF Measurement Block Diagram

Measuring instruments

NF Analyzer : Keysight N8973A

Noise Source : Keysight N4000A

Setting the NF analyzer

Measurement mode form

Device under test : Amplifier

System downconverter : off

Mode setup form

Sideband : LSB

Averages : 8

Average mode : Point

Bandwidth : 4 MHz

Loss comp : off

Tcold : setting the temperature of noise source (Auto)

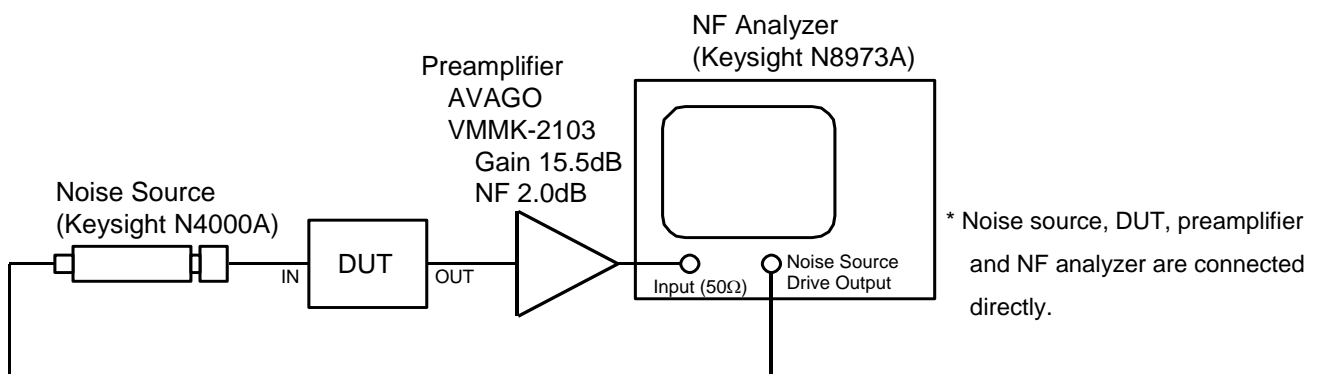
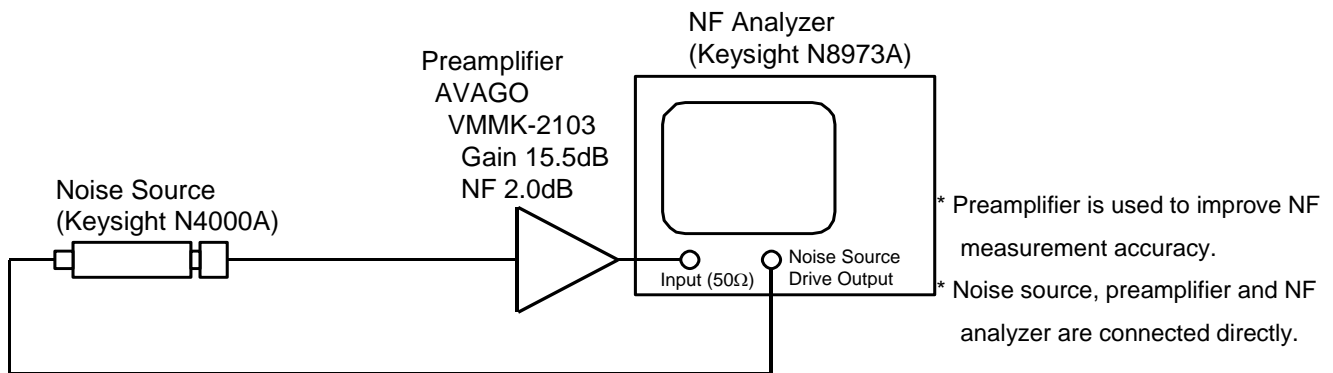

■ PACKAGE DIMENSIONS

UNIT: mm

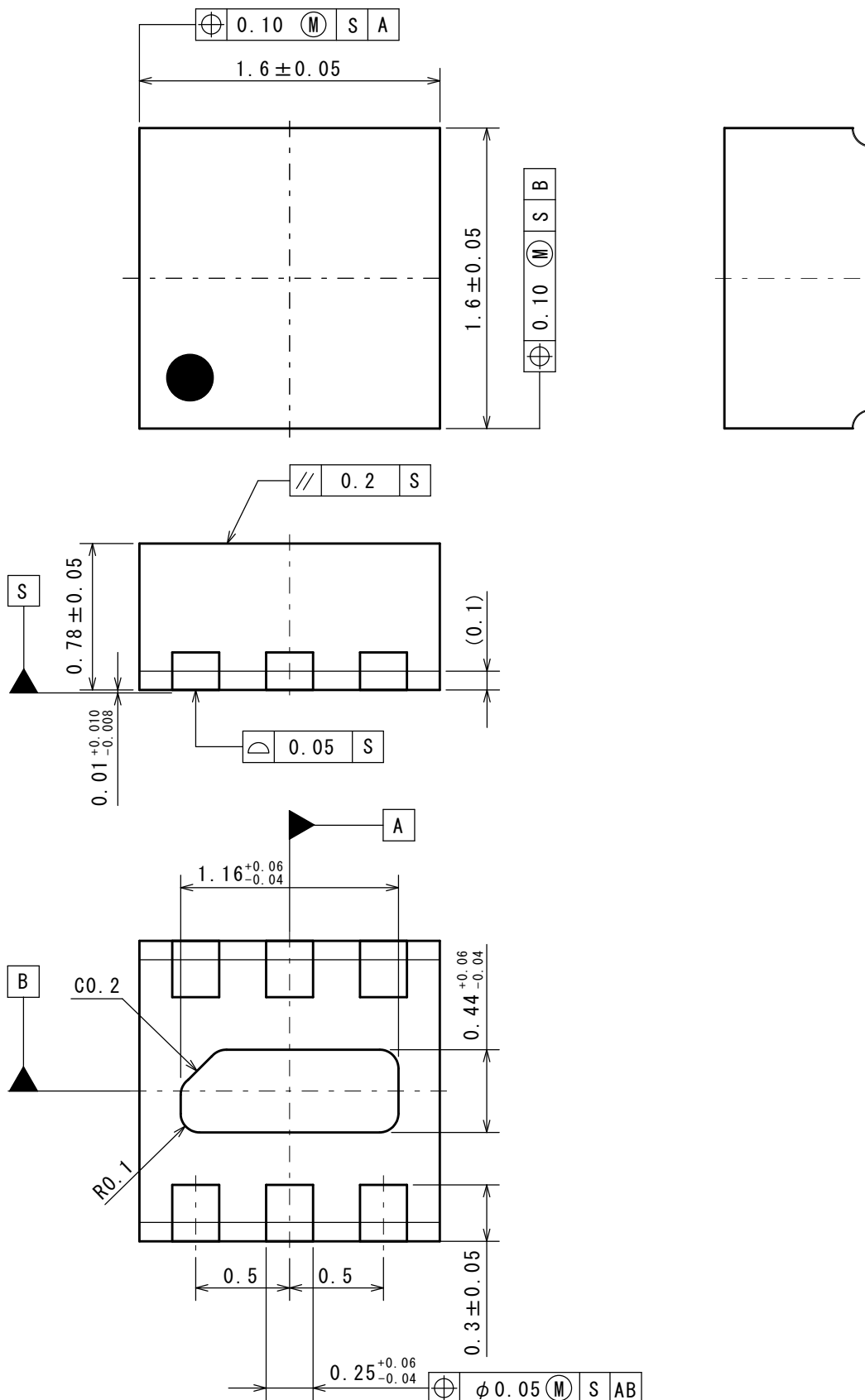

■ EXAMPLE OF SOLDER PADS DIMENSIONS

UNIT: mm

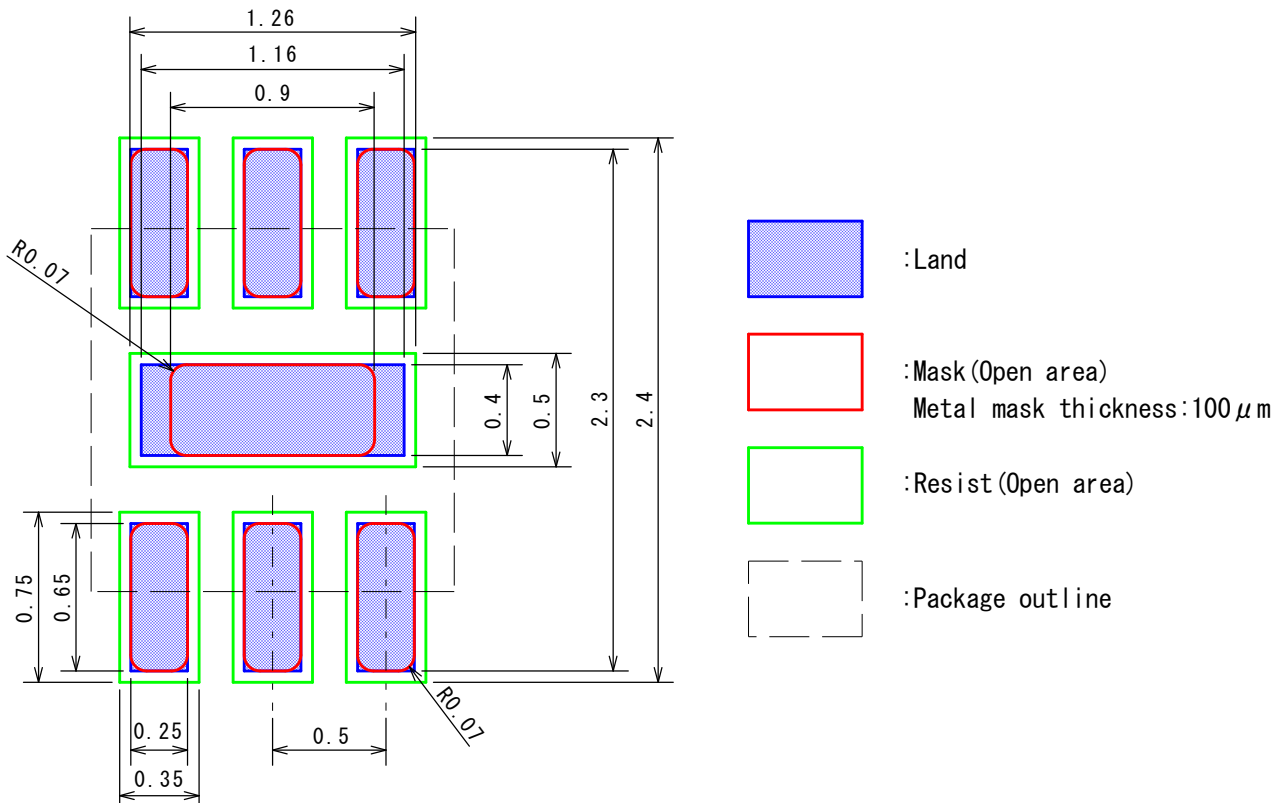

Nisshinbo Micro Devices Inc.

DFN1616-6-GE

Ver. PI-DFN1616-6-GE-E-A

■ PACKING SPEC

UNIT: mm

(1) Taping dimensions / Insert direction

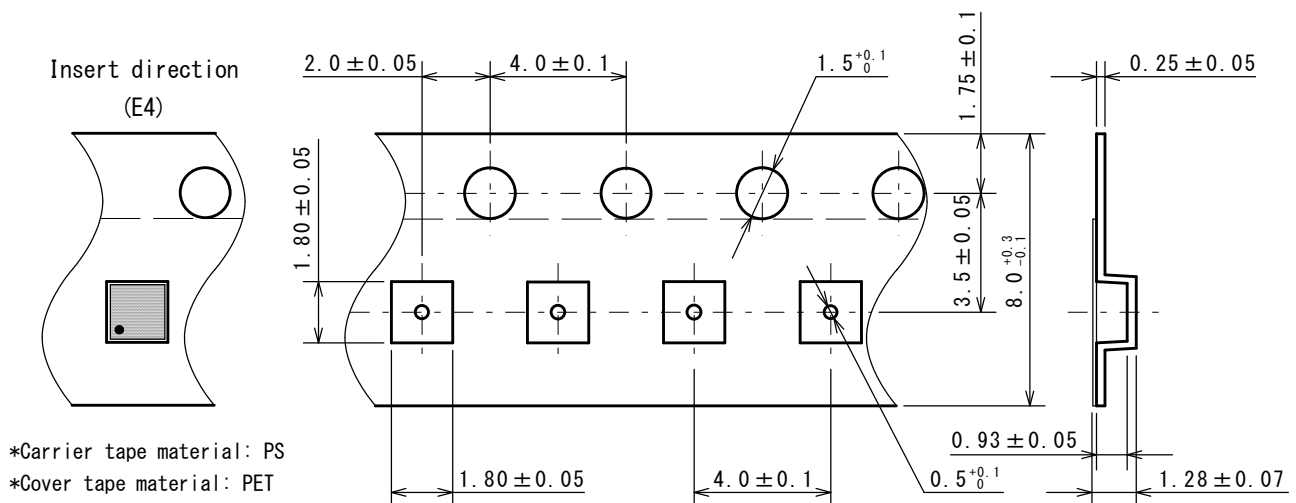
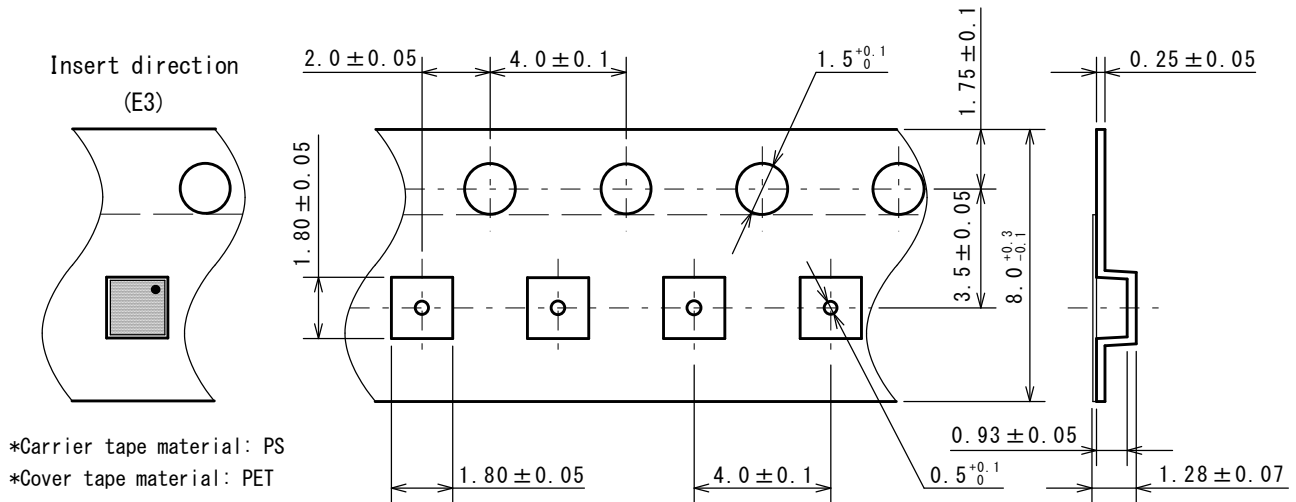

Nisshinbo Micro Devices Inc.

DFN1616-6-GE

Ver. PI-DFN1616-6-GE-E-A

(2) Taping state

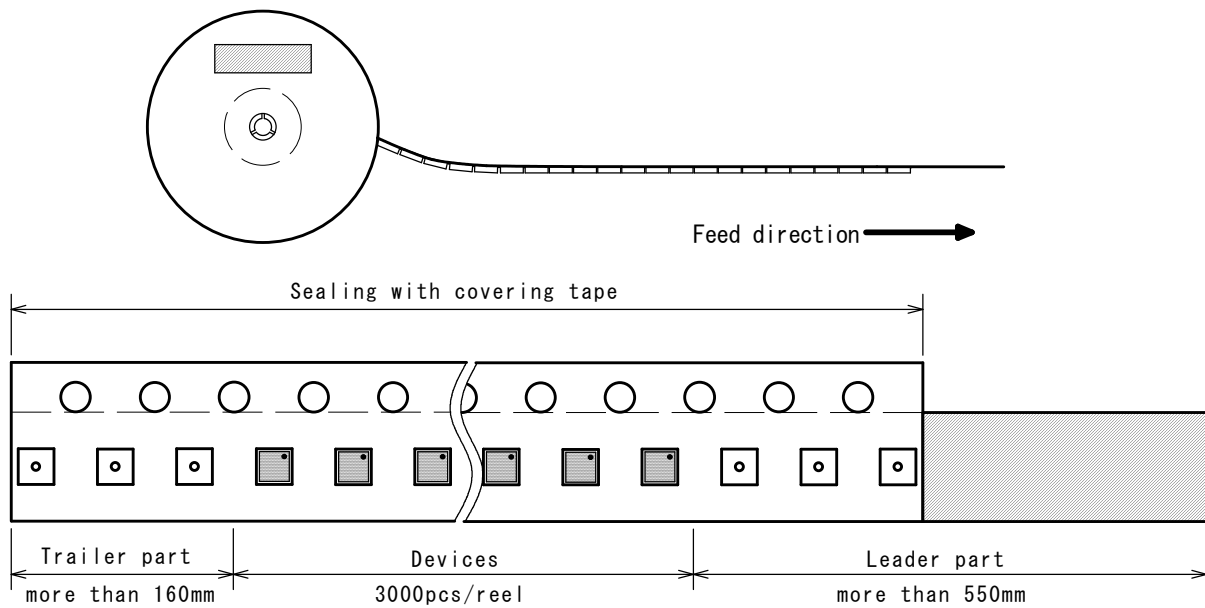

(3) Reel dimensions

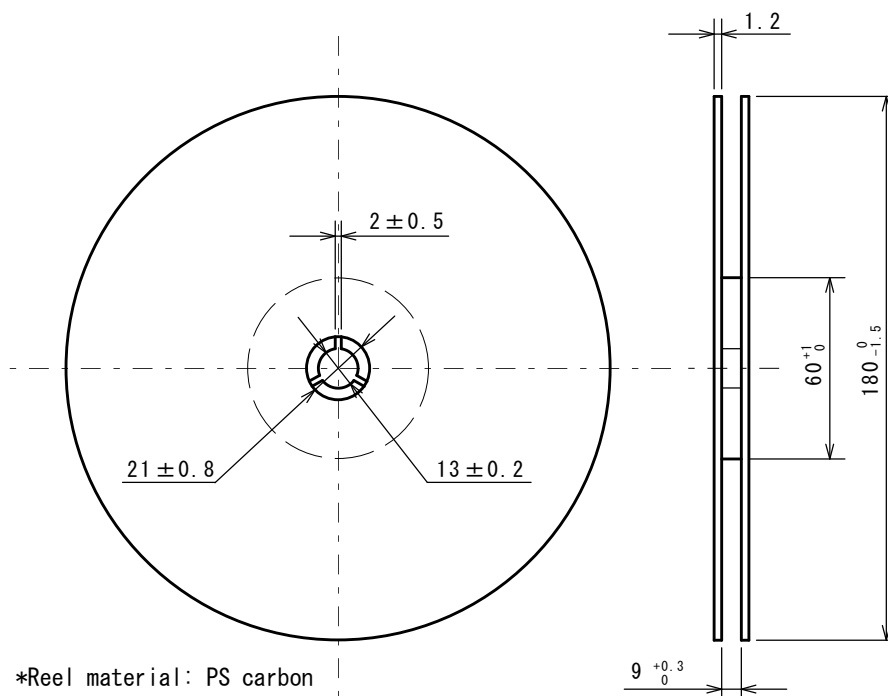

Nisshinbo Micro Devices Inc.

DFN1616-6-GE

Ver. PI-DFN1616-6-GE-E-A

(4) Peeling strength

Peeling strength of cover tape

- Peeling angle 165~180° degrees to the taped surface.
- Peeling speed 300mm/min
- Peeling strength 0.1~0.7N

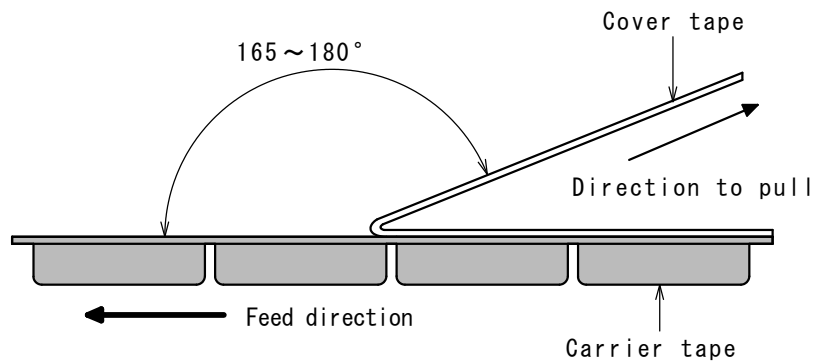

(5) Packing state

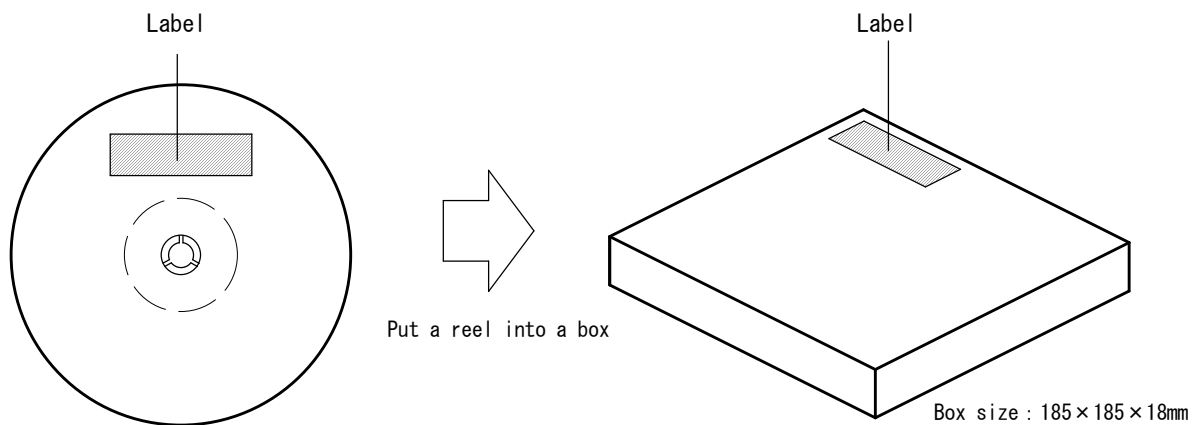

(6) Label

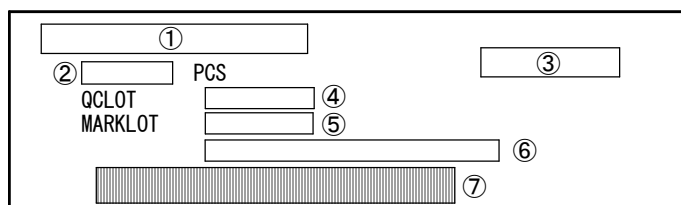

①	Product name
②	Quantity
③	Product code
④	QC LOT No.
⑤	MARK LOT No.
⑥	Environmental notation
⑦	Barcode

1. The products and the product specifications described in this document are subject to change or discontinuation of production without notice for reasons such as improvement. Therefore, before deciding to use the products, please refer to our sales representatives for the latest information thereon.
2. The materials in this document may not be copied or otherwise reproduced in whole or in part without the prior written consent of us.
3. This product and any technical information relating thereto are subject to complementary export controls (so-called KNOW controls) under the Foreign Exchange and Foreign Trade Law, and related politics ministerial ordinance of the law. (Note that the complementary export controls are inapplicable to any application-specific products, except rockets and pilotless aircraft, that are insusceptible to design or program changes.) Accordingly, when exporting or carrying abroad this product, follow the Foreign Exchange and Foreign Trade Control Law and its related regulations with respect to the complementary export controls.
4. The technical information described in this document shows typical characteristics and example application circuits for the products. The release of such information is not to be construed as a warranty of or a grant of license under our or any third party's intellectual property rights or any other rights.
5. The products listed in this document are intended and designed for use as general electronic components in standard applications (office equipment, telecommunication equipment, measuring instruments, consumer electronic products, amusement equipment etc.). Those customers intending to use a product in an application requiring extreme quality and reliability, for example, in a highly specific application where the failure or misoperation of the product could result in human injury or death should first contact us.
 - Aerospace Equipment
 - Equipment Used in the Deep Sea
 - Power Generator Control Equipment (nuclear, steam, hydraulic, etc.)
 - Life Maintenance Medical Equipment
 - Fire Alarms / Intruder Detectors
 - Vehicle Control Equipment (automotive, airplane, railroad, ship, etc.)
 - Various Safety Devices
 - Traffic control system
 - Combustion equipment

In case your company desires to use this product for any applications other than general electronic equipment mentioned above, make sure to contact our company in advance. Note that the important requirements mentioned in this section are not applicable to cases where operation requirements such as application conditions are confirmed by our company in writing after consultation with your company.

6. We are making our continuous effort to improve the quality and reliability of our products, but semiconductor products are likely to fail with certain probability. In order to prevent any injury to persons or damages to property resulting from such failure, customers should be careful enough to incorporate safety measures in their design, such as redundancy feature, fire containment feature and fail-safe feature. We do not assume any liability or responsibility for any loss or damage arising from misuse or inappropriate use of the products.
7. The products have been designed and tested to function within controlled environmental conditions. Do not use products under conditions that deviate from methods or applications specified in this datasheet. Failure to employ the products in the proper applications can lead to deterioration, destruction or failure of the products. We shall not be responsible for any bodily injury, fires or accident, property damage or any consequential damages resulting from misuse or misapplication of the products.
8. **Quality Warranty**
 - 8-1. **Quality Warranty Period**

In the case of a product purchased through an authorized distributor or directly from us, the warranty period for this product shall be one (1) year after delivery to your company. For defective products that occurred during this period, we will take the quality warranty measures described in section 8-2. However, if there is an agreement on the warranty period in the basic transaction agreement, quality assurance agreement, delivery specifications, etc., it shall be followed.
 - 8-2. **Quality Warranty Remedies**

When it has been proved defective due to manufacturing factors as a result of defect analysis by us, we will either deliver a substitute for the defective product or refund the purchase price of the defective product.

Note that such delivery or refund is sole and exclusive remedies to your company for the defective product.
 - 8-3. **Remedies after Quality Warranty Period**

With respect to any defect of this product found after the quality warranty period, the defect will be analyzed by us. On the basis of the defect analysis results, the scope and amounts of damage shall be determined by mutual agreement of both parties. Then we will deal with upper limit in Section 8-2. This provision is not intended to limit any legal rights of your company.
9. Anti-radiation design is not implemented in the products described in this document.
10. The X-ray exposure can influence functions and characteristics of the products. Confirm the product functions and characteristics in the evaluation stage.
11. WLCSP products should be used in light shielded environments. The light exposure can influence functions and characteristics of the products under operation or storage.
12. Warning for handling Gallium and Arsenic (GaAs) products (Applying to GaAs MMIC, Photo Reflector). These products use Gallium (Ga) and Arsenic (As) which are specified as poisonous chemicals by law. For the prevention of a hazard, do not burn, destroy, or process chemically to make them as gas or power. When the product is disposed of, please follow the related regulation and do not mix this with general industrial waste or household waste.
13. Please contact our sales representatives should you have any questions or comments concerning the products or the technical information.



Nisshinbo Micro Devices Inc.

Official website

<https://www.nisshinbo-microdevices.co.jp/en/>

Purchase information

<https://www.nisshinbo-microdevices.co.jp/en/buy/>