

# EZ-LIGHT® K70 Wireless Touch Button

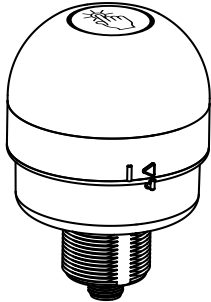

## Datasheet

Sure Cross® K70 Wireless Battery-Powered Touch Button combines the best of Banner's popular Touch Button family with its reliable, field-proven, Sure Cross wireless architecture.



- Available in 900 MHz and 2.4 GHz ISM radio frequencies
- Up to three colors in one device
- Rugged, water-resistant IP65 housing with UV-stabilized material
- Bright, uniform indicator segments appear gray when off to eliminate false indication from ambient light
- Excellent immunity to false triggering by water spray, detergents, oils, and other foreign materials
- Ergonomically designed to eliminate hand, wrist, and arm stresses associated with repeated switch operation; requires no physical force to operate



**Important:** Please download the complete K70 Wireless Battery-Powered Touch Button technical documentation, available in multiple languages, from [www.bannerengineering.com](http://www.bannerengineering.com) for details on the proper use, applications, Warnings, and installation instructions of this device.



**Important:** Por favor descargue desde [www.bannerengineering.com](http://www.bannerengineering.com) toda la documentación técnica de los K70 Wireless Battery-Powered Touch Button, disponibles en múltiples idiomas, para detalles del uso adecuado, aplicaciones, advertencias, y las instrucciones de instalación de estos dispositivos.



**Important:** Veuillez télécharger la documentation technique complète des K70 Wireless Battery-Powered Touch Button sur notre site [www.bannerengineering.com](http://www.bannerengineering.com) pour les détails sur leur utilisation correcte, les applications, les notes de sécurité et les instructions de montage.

## Models

### K70 Wireless Model Key

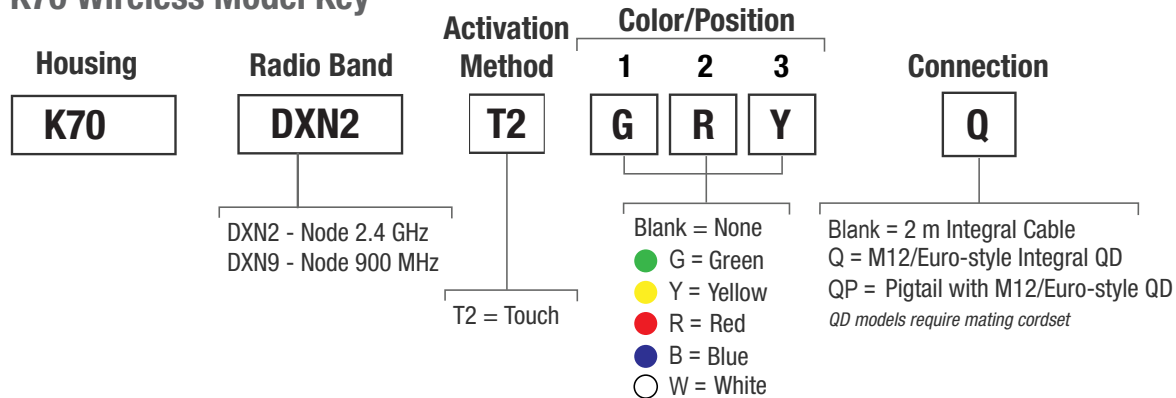

Example model number: K70DXN9T2GRYQ



## Configuration Instructions

### Set the Radio Module DIP Switches

Before applying power to the device, set the radio module's DIP switches. After changing DIP switch positions, cycle power to the device for the changes to take effect.

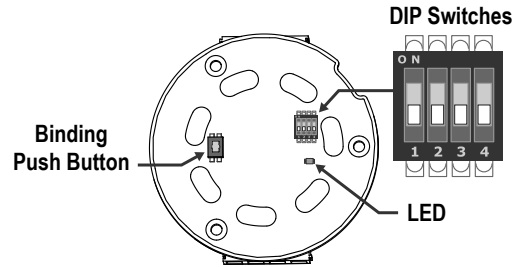

**DIP Switch 1: Radio Transmit Power**—The 900 MHz radios transmit at 1 Watt (30 dBm) or 250 mW (24 dBm). The 250 mW mode reduces the radio's range but improves the battery life in short range applications. For 2.4 GHz models, this DIP switch is disabled. The transmit power for 2.4 GHz is fixed at about 65 mW EIRP (18 dBm).

DIP Switch 1	900 MHz Models	2.4 GHz Models
OFF (default)	1 Watt (30 dBm) Operation	Disabled
ON	250 mW (24 dBm) Operation	

**DIP Switch 2: Touch Button Behavior**—Use DIP Switch 2 to set the latching or momentary behavior of the touch button.

DIP Switch 2	900 MHz and 2.4 GHz Models
OFF (default)	Latching—Output toggles between activated and non-activated on successive touches
ON	Momentary—Remains activated while touch is present

**DIP Switches 3 and 4: Indicator Mapping**—DIP switches 3 and 4 map the activation of the touch button to the one of the indicator light colors/positions to give visual feedback when the touch output is active.

DIP Switches		Touch Button to Indicator Mapping
3	4	
OFF (default)	OFF (default)	Mapped to Color / Position 1
OFF	ON	Mapped to Color / Position 2
ON	OFF	Mapped to Color / Position 3
ON	ON	Mapping disabled

### Assembling the K70

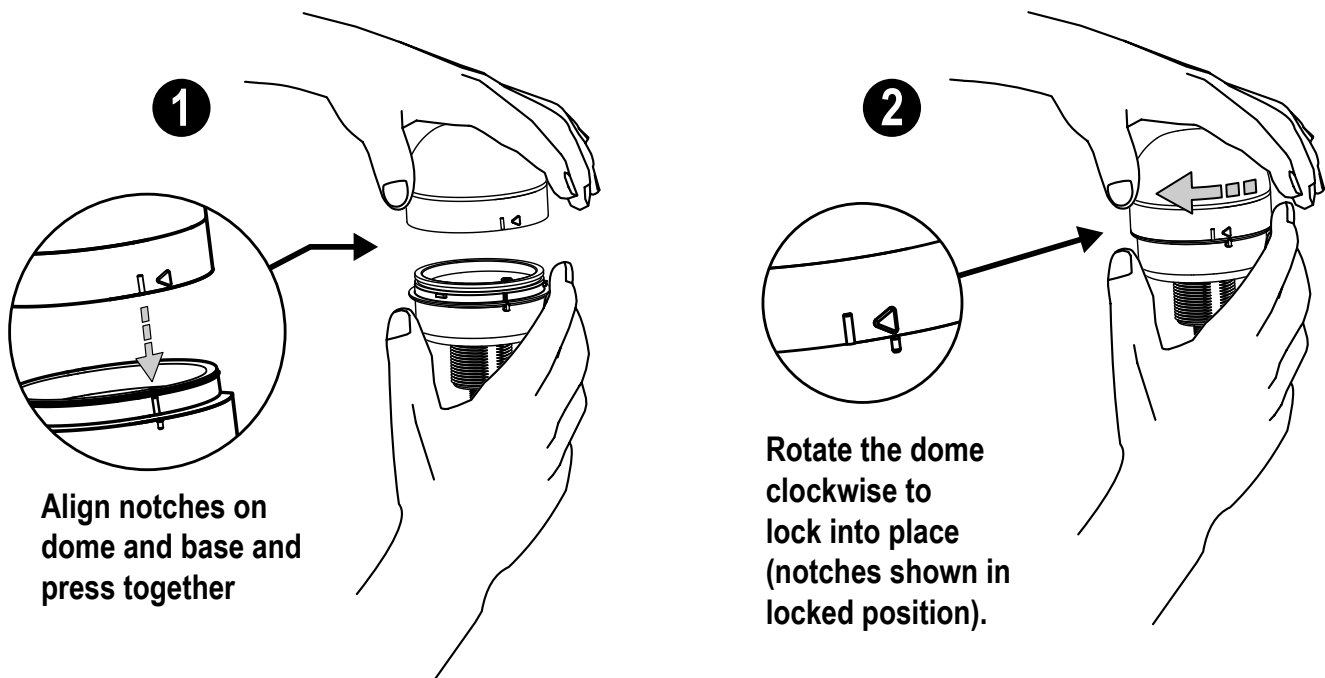

## Wiring Diagrams

Figure 1. Wiring diagram

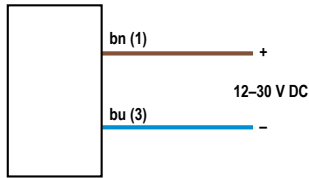
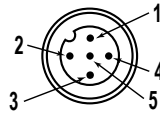

Figure 2. 5-pin M12 Male Quick Disconnect Pinout



Key:

1 = brown  
3 = blue

## Bind the K70 to the Gateway and Assign the Node Address

Before beginning the binding procedure, apply power to all the devices.

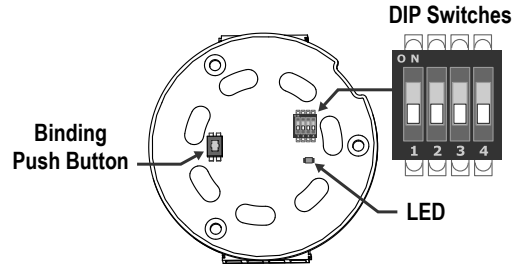

### 1. Enter binding mode.

- For housed Gateways, triple-click button 2.
- For board-level Gateway modules, triple-click the button.
- For DXMs, under the **ISM Radio** menu, use the down arrow button to highlight the **Binding** menu. Click **ENTER**.

On the board modules, the green/red LED flashes. On the housed models, both LEDs flash red.

### 2. Assign the K70 a Node address using the Gateway's rotary dials or the DXM's arrow keys.

- On a Gateway: Use the left rotary dial for the left digit and the right rotary dial for the right digit. For example, to assign your K70 to Node 01, set the left dial to 0 and the right dial to 1.
- On the DXM: Use the arrow keys to select the Node ID, then press **ENTER**. The display shows **Binding**.

Valid Node addresses are 01 through 47.

### 3. Access the circuit board in the radio module of the K70.

### 4. Enter binding mode on the K70 by triple-clicking the binding button.

The bicolor LED flashes alternately while it searches for a Gateway in binding mode. After the K70 is bound, the LED is red and green for four seconds (looks amber), then it flashes four times (looks amber). The K70 automatically exits binding mode, cycles power, and enters Run mode.

### 5. For DXMs, click **BACK** to exit binding for that specific Node address.

### 6. Label the Node with the assigned address for future references.

This makes it easier to identify the physical Node location within a multi-Node network.

### 7. Reassemble the components back onto the base.

### 8. Repeat steps 2 through 5 for as many K70 Wireless Battery-Powered Touch Buttons as are needed for your network.

### 9. After binding all K70s, exit binding mode on the Gateway.

- For housed Gateways, double-click button 2.
- For board-level Gateway modules, double-click the button.
- For DXM models, click **BACK** until you return to the main menu.

## LED Behavior for the Nodes

Nodes do not sample inputs until they are communicating with the Gateway. The radios and antennas must be a minimum distance apart to function properly. Recommended minimum distances are:

900 MHz 150 mW and 250 mW radios: 6 feet

900 MHz 1 Watt radios: 15 feet

2.4 GHz 65 mW radios: 1 foot

LED (Bi-color)	Node Status
Flashing green	Radio link okay
Green and red flashing alternately	In Binding mode
Both colors are solid for 4 seconds, then flash 4 times; looks amber	Binding mode is complete
Flashing red, once every 3 seconds	Radio link error
Flashing red, once every second	Device error

## Sure Cross® DX80 Performance Configuration Software

The configuration software offers an easy way to link I/O points in your wireless network, view I/O register values, and set system communication parameters when a host system is not part of the wireless network. The software runs on any computer with the Windows Vista, Windows 7, Windows 8, or Windows 10 operating system.

Figure 3. Device Configuration screen

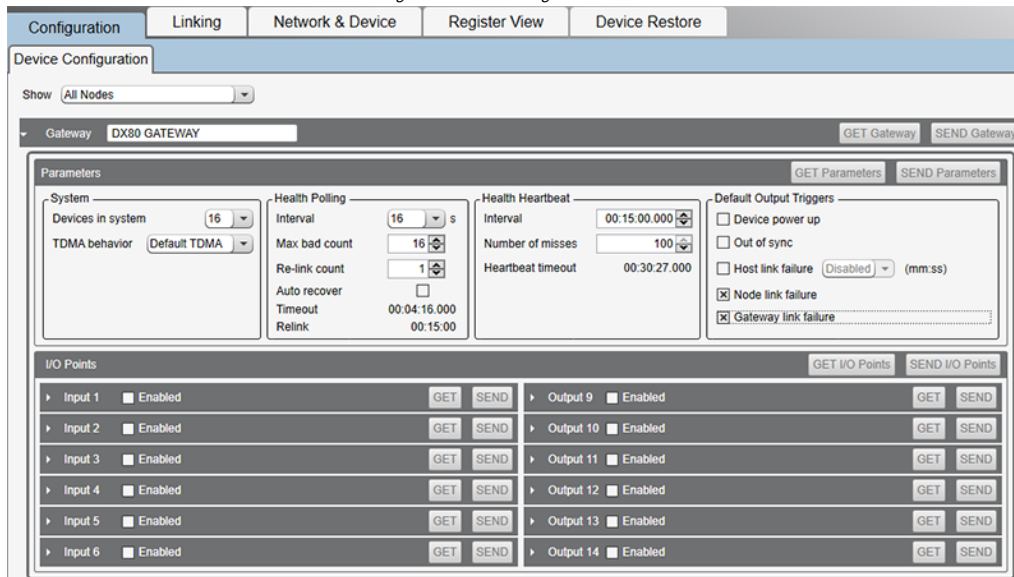

Use a USB to RS-485 adapter cable to connect a standalone DX80 Gateway to the computer. For DXM Controllers with an internal DX80 radio, connect a computer to the DXM Controller using the supplied USB or Ethernet connection. Download the most recent revisions of the configuration software from Banner Engineering's website: <https://www.bannerengineering.com/us/en/products/wireless-sensor-networks/reference-library/software.html>.

The USB to RS-485 adapter cable is not required for the DXM Controller. For standalone DX80 Gateway devices use:

- USB to RS-485 adapter cable model **BWA-UCT-900** for 1 Watt radios
- USB to RS-485 adapter cable model **BWA-HW-006** for all other radios

## Creating Flash Patterns

Use the DX80 Performance Configuration Software to create the flash pattern.

To create a flash pattern:

1. Enable the appropriate output if it is not yet enabled.
2. Click **GET** to download the input/output current configuration from the device to the configuration software. This automatically populates the Output configuration settings specific to the Node type.
3. For this example, configure output 9 is enabled and configured as discrete output 1 (color 1 for this K70 light). Different models may use distinct output types and I/O configuration values.
4. Define the flash pattern by selecting the appropriate checkboxes in the **Flash Pattern** section. In this example, the light will flash twice a second.
5. Click **SEND** to upload the configuration to the device.

Figure 4. Defining a flash pattern for discrete output 1

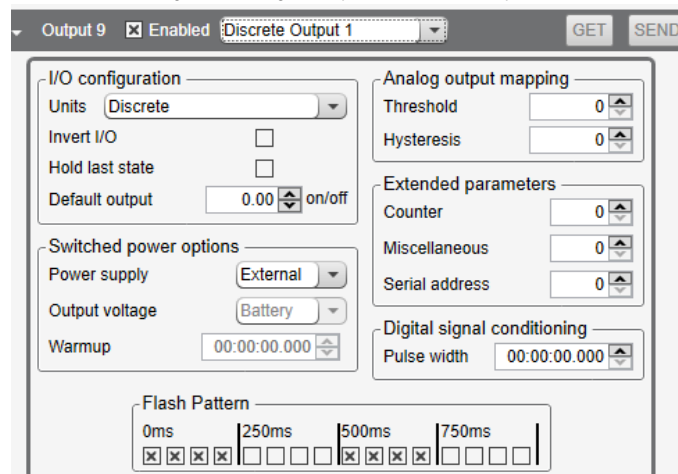

## Latch/Toggle for Host Systems or Scripting

For most models, use the DIP switches to set latch and toggle modes. Not all models have a DIP switch setting for Latch mode. If your model does not have those DIP switch settings, use the User Configuration Tool to enable latch or toggle inputs.

1. Set the DIP switch to allow the User Configuration Software to configure the device and ignore the DIP switch settings.
2. Connect the Gateway to the computer with the software installed and launch the software.
  - a. Click **Device > Connection Settings**.
  - b. Select appropriate connection type (**Serial** or **TCP**).
  - c. Select the correct COMM port or enter the IP Address and click **Connect**.
3. Go to **Configuration > Device Configuration**.
4. For the Node you are configuring, click **GET Node** to load all of that Node's parameter settings.
5. Click on the arrow next to the Node to expand the list of that Node's inputs and outputs.
6. For the specific input, click on the arrow next to the input number to expand those parameters.
7. Under the **Serial options** section, select **Latch** or **Toggle** or **None** (momentary) in the **Sync Counter**'s drop-down list.
8. Click **SEND Node** to send the changes to that Node's parameters to the network.

#### Latch

After an input is activated (set to 1) with a button press or using the messages, the input remains at 1 until cleared or alternated by writing to I/O 15. Latching prevents a successive button press from setting the input to 0.

#### Toggle

The input toggles between 0 and 1 with successive button pushes or touches. Write to I/O 15 to clear the toggle or to alternate the current state of the toggle.

To change the latch/toggle register value using a host system, write the following to the Node's I/O point 15:

Table 1: Latch/toggle register values

For I/O point	Write this decimal value	
	To clear the register value	To alternate the state of the latch/toggle register value
1	5377	5505
2	5378	5506
3	5380	5508
4	5384	5512
5	5392	5520
6	5408	5536
All Points	5439	5567



**Important:** DO NOT write these values to I/O 15 if the device is used in momentary mode.

## Modbus Registers

I/O	Modbus Holding Register		I/O Type	I/O Range		Holding Register Representation (Dec.)		Color #
	Gateway	Any Node		Min.	Max.	Min.	Max.	
1	1	1 + (Node# × 16)	Touch Input 1	0	1	0	1	
7	7	7 + (Node# × 16)	Reserved					
8	8	8 + (Node# × 16)	Device Message					
9	9	9 + (Node# × 16)	Discrete OUT 9	0	1	0	1	Color 1
10	10	10 + (Node# × 16)	Discrete OUT 10	0	1	0	1	Color 2
11	11	11 + (Node# × 16)	Discrete OUT 11	0	1	0	1	Color 3
15	15	15 + (Node# × 16)	Control Message					
16	16	16 + (Node# × 16)	Reserved					

Use the User Configuration Tool (UCT) software to define unique synchronous flash patterns for the lights.

## Specifications

### Touch Button

#### Supply Voltage

12 to 30 V DC (Outside the USA: 12 V DC to 24 V DC,  $\pm 10\%$ )<sup>‡</sup>  
 900 MHz Consumption: Maximum current draw is < 40 mA and typical current draw is < 30 mA at 24 V DC. (2.4 GHz consumption is less.)

#### Supply Current

< 220 mA maximum current at 12 V DC  
 < 110 mA maximum current at 30 V DC

#### Supply Protection Circuitry

Protected against transient voltages

#### Construction

Polycarbonate

#### Connections

Integral 5-pin M12 male quick-disconnect connector; 150 mm (6 in) PVC cable with a 5-pin M12 male quick-disconnect connector; or a 2 m (6.5 ft) terminated 5-wire PVC cable depending on the model ordered

#### Operating Conditions

-40 °C to +50 °C (-40 °F to +122 °F)  
 95% at +50 °C maximum relative humidity (non-condensing)

#### Environmental Rating

IP65

#### Vibration and Mechanical Shock

Vibration: 10 Hz to 55 Hz, 0.5 mm peak-to-peak amplitude per IEC 60068-2-6  
 Shock: 15G 11 ms duration, half sine wave per IEC 60068-2-27

#### Certifications



**Banner Engineering Europe**  
 Park Lane, Culliganlaan 2F bus  
 3, 1831 Diegem, BELGIUM  
 (CE approval only applies to 2.4 GHz models)



#### Indicator Response Time

Off Response: 150  $\mu$ s (maximum) at 12 to 30 V DC  
 On Response: 180 ms (maximum) at 12 V DC; 50 ms (maximum) at 30 V DC

#### Indicators

1 to 3 colors depending on model: Green, Red, Yellow, Blue, and White  
 LEDs are independently selected

#### Required Overcurrent Protection



**WARNING:** Electrical connections must be made by qualified personnel in accordance with local and national electrical codes and regulations.

Overcurrent protection is required to be provided by end product application per the supplied table.

Overcurrent protection may be provided with external fusing or via Current Limiting, Class 2 Power Supply.

Supply wiring leads < 24 AWG shall not be spliced.

For additional product support, go to [www.bannerengineering.com](http://www.bannerengineering.com).

Supply Wiring (AWG)	Required Overcurrent Protection (Amps)
20	5.0
22	3.0
24	2.0
26	1.0
28	0.8
30	0.5

### Radio

#### Radio Range<sup>‡</sup>

900 MHz, 1 Watt: Up to 3.2 km (2 miles) with line of sight (internal antenna)  
 2.4 GHz, 65 mW: Up to 1000 m (3280 ft) with line of sight (internal antenna)

#### 900 MHz Compliance (1 Watt)

FCC ID UE3RM1809: FCC Part 15, Subpart C, 15.247  
 IC: 7044A-RM1809  
 IFT: RCPBARM13-2283



(NOM approval only applies to 900 MHz models)

#### 2.4 GHz Compliance

FCC ID UE300DX80-2400: FCC Part 15, Subpart C, 15.247  
 Radio Equipment Directive (RED) 2014/53/EU  
 IC: 7044A-DX8024

ANATEL: 15966-21-04042 Este equipamento não tem direito à proteção contra interferência prejudicial e não pode causar interferência em sistemas devidamente autorizados. Para maiores informações, consulte o site da ANATEL [www.gov.br/anatel/pt-br/](http://www.gov.br/anatel/pt-br/)

#### Antenna Minimum Separation Distance

900 MHz, 150 mW and 250 mW: 2 m (6 ft)  
 900 MHz, 1 Watt: 4.57 m (15 ft)  
 2.4 GHz, 65 mW: 0.3 m (1 ft)

#### Radiated Immunity HF

10 V/m (EN 61000-4-3)

#### Spread Spectrum Technology

FHSS (Frequency Hopping Spread Spectrum)

#### Link Timeout (Performance)

Gateway: Configurable via User Configuration Software  
 Node: Defined by Gateway

## Dimensions

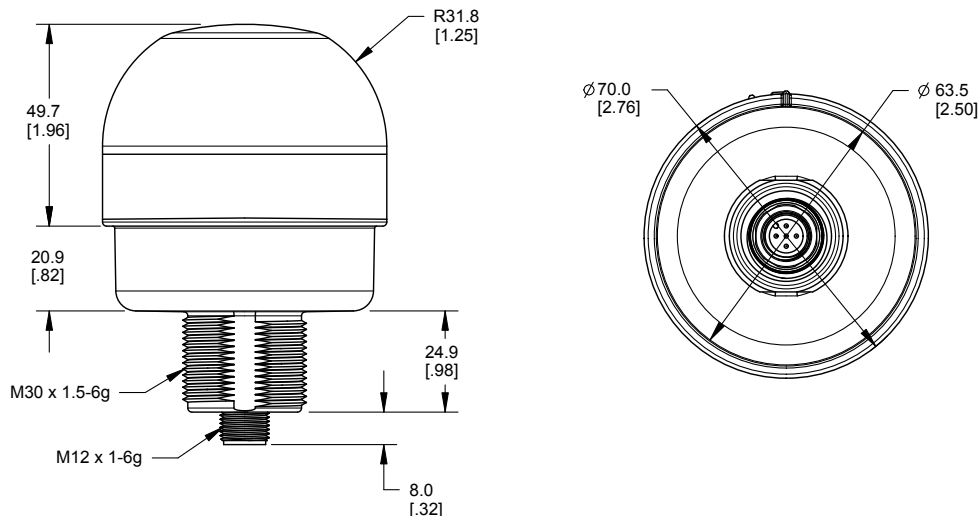

<sup>‡</sup> For European applications, power this device from a Limited Power Source as defined in EN 60950-1.

<sup>‡</sup> Range depends on the environment and decreases significantly without line of sight. Always verify your wireless network's range by performing a Site Survey.

All measurements are listed in millimeters [inches], unless noted otherwise.

## Accessories

### Cordsets

5-Pin Threaded M12 Cordsets—Single Ended				
Model	Length	Style	Dimensions	Pinout (Female)
MQDC1-501.5	0.5 m (1.5 ft)	Straight		
MQDC1-506	2 m (6.5 ft)			
MQDC1-515	5 m (16.4 ft)			
MQDC1-530	9 m (29.5 ft)	Right-Angle		
MQDC1-506RA	2 m (6.5 ft)			
MQDC1-515RA	5 m (16.4 ft)			
MQDC1-530RA	9 m (29.5 ft)			

All measurements are listed in millimeters [inches], unless noted otherwise.

### Brackets

All measurements are listed in millimeters, unless noted otherwise.

#### LMB30LP

- Low profile
- 30 mm mounting hole
- 300 series stainless steel

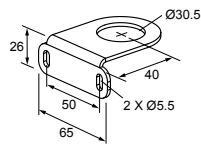

#### SMB30A

- Right-angle bracket with curved slot for versatile orientation
- Clearance for M6 (¼ in) hardware
- Mounting hole for 30 mm sensor
- 12-ga. stainless steel

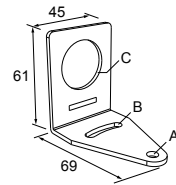

Hole center spacing: A to B=40  
Hole size: A=ø 6.3, B= 27.1 x 6.3, C=ø 30.5

#### SMB30MM

- 12-ga. stainless steel bracket with curved mounting slots for versatile orientation
- Clearance for M6 (¼ in) hardware
- Mounting hole for 30 mm sensor

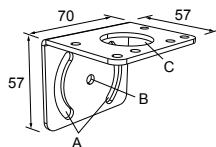

Hole center spacing: A = 51, A to B = 25.4  
Hole size: A = 42.6 x 7, B = ø 6.4, C = ø 30.1

#### SMBAMS30P

- Flat SMBAMS series bracket
- 30 mm hole for mounting sensors
- Articulation slots for 90°+ rotation
- 12-ga. 300 series stainless steel

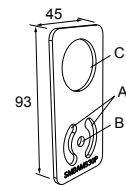

Hole center spacing: A=26.0, A to B=13.0  
Hole size: A=26.8 x 7.0, B=ø 6.5, C=ø 31.0

#### SSA-MBK-EEC1

- Single 30 mm hole
- 8 gauge steel, black finish (powder coat)
- Front surface for customer applied labels

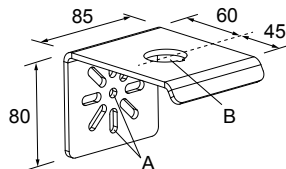

Hole size: A = ø 7, B = ø 30

## Banner Engineering Corp. Limited Warranty

Banner Engineering Corp. warrants its products to be free from defects in material and workmanship for one year following the date of shipment. Banner Engineering Corp. will repair or replace, free of charge, any product of its manufacture which, at the time it is returned to the factory, is found to have been defective during the warranty period. This warranty does not cover damage or liability for misuse, abuse, or the improper application or installation of the Banner product.

**THIS LIMITED WARRANTY IS EXCLUSIVE AND IN LIEU OF ALL OTHER WARRANTIES WHETHER EXPRESS OR IMPLIED (INCLUDING, WITHOUT LIMITATION, ANY WARRANTY OF MERCHANTABILITY OR FITNESS FOR A PARTICULAR PURPOSE), AND WHETHER ARISING UNDER COURSE OF PERFORMANCE, COURSE OF DEALING OR TRADE USAGE.**

This Warranty is exclusive and limited to repair or, at the discretion of Banner Engineering Corp., replacement. **IN NO EVENT SHALL BANNER ENGINEERING CORP. BE LIABLE TO BUYER OR ANY OTHER PERSON OR ENTITY FOR ANY EXTRA COSTS, EXPENSES, LOSSES, LOSS OF PROFITS, OR ANY INCIDENTAL, CONSEQUENTIAL OR SPECIAL DAMAGES RESULTING FROM ANY PRODUCT DEFECT OR FROM THE USE OR INABILITY TO USE THE PRODUCT, WHETHER ARISING IN CONTRACT OR WARRANTY, STATUTE, TORT, STRICT LIABILITY, NEGLIGENCE, OR OTHERWISE.**

Banner Engineering Corp. reserves the right to change, modify or improve the design of the product without assuming any obligations or liabilities relating to any product previously manufactured by Banner Engineering Corp. Any misuse, abuse, or improper application or installation of this product or use of the product for personal protection applications when the product is identified as not intended for such purposes will void the product warranty. Any modifications to this product without prior express approval by Banner Engineering Corp will void the product warranties. All specifications published in this document are subject to change; Banner reserves the right to modify product specifications or update documentation at any time. Specifications and product information in English supersede that which is provided in any other language. For the most recent version of any documentation, refer to: [www.bannerengineering.com](http://www.bannerengineering.com).

For patent information, see [www.bannerengineering.com/patents](http://www.bannerengineering.com/patents).

## Notas Adicionales

Información México: La operación de este equipo está sujeta a las siguientes dos condiciones: 1) es posible que este equipo o dispositivo no cause interferencia perjudicial y 2) este equipo debe aceptar cualquier interferencia, incluyendo la que pueda causar su operación no deseada.

Banner es una marca registrada de Banner Engineering Corp. y podrán ser utilizadas de manera indistinta para referirse al fabricante. "Este equipo ha sido diseñado para operar con las antenas tipo Omnidireccional para una ganancia máxima de antena de 6 dBd y Yagi para una ganancia máxima de antena 10 dBd que en seguida se enlistan. También se incluyen aquellas con aprobación ATEX tipo Omnidireccional siempre que no excedan una ganancia máxima de antena de 6dBd. El uso con este equipo de antenas no incluidas en esta lista o que tengan una ganancia mayor que 6 dBd en tipo omnidireccional y 10 dBd en tipo Yagi, quedan prohibidas. La impedancia requerida de la antena es de 50 ohms."

Antenas SMA	Modelo	Antenas Tipo-N	Modelo
Antena, Omni 902-928 MHz, 2 dBd, junta de caucho, RP-SMA Macho	<b>BWA-902-C</b>	Antena, Omni 902-928 MHz, 6 dBd, fibra de vidrio, 1800mm, N Hembra	<b>BWA-906-A</b>
Antena, Omni 902-928 MHz, 5 dBd, junta de caucho, RP-SMA Macho	<b>BWA-905-C</b>	Antena, Yagi, 900 MHz, 10 dBd, N Hembra	<b>BWA-9Y10-A</b>

## Mexican Importer

Banner Engineering de México, S. de R.L. de C.V.  
David Alfaro Siqueiros 103 Piso 2 Valle oriente  
San Pedro Garza García Nuevo León, C. P. 66269

81 8363.2714

## ANATEL

Modelo (Model): DX80-2400—Este equipamento não tem direito à proteção contra interferência prejudicial e não pode causar interferência em sistemas devidamente autorizados. Para maiores informações, consulte o site da ANATEL [www.gov.br/anatel/pt-br/](http://www.gov.br/anatel/pt-br/)



ANATEL: 15966-21-04042



more sensors, more solutions