

4.5-14V Input 12A Output Point-of-Load Converter



Features

- Wide input ranges: 4.5V –14V
- High efficiency: 93.3% @ 5V/12A output and 12V input
- DOSA standard footprint and pin-out
- Remote sense, remote enable control, power good signal, output trim, output over-current/short-circuit protections,
- Monotonic start-up
- All components meet UL 94V0

Applications

- Intermediate bus architecture
- Telecom, datacom, networking equipment
- Electronic data processing, servers
- Distributed power architectures

Options

- Negative/Positive enable logic
- Output voltage tracking/Sequence

Part Numbering System

NKS	1	000	□	12	S	□	□
Series Name:	Input Voltage:	Output Voltage:	Enabling Logic:	Rated Output Current:	Pin Length Options:	Electrical Options:	Mechanical Options
NKS	1: 4.5-14V	000: available* (0.59 -5.5V)	P: positive N: negative	Unit: A 12: 12A	S: SMT*	0: None 1: Output tracking	Lead-free, (ROHS-6 Compliant) 5: open-frame

*: Standard product has variable output voltage (adjustable between 0.59 – 5.5V). Please contact the factory if fixed output voltage models are needed.

Absolute Maximum Ratings

Excessive stresses over these absolute maximum ratings can cause damage to the converter. Operation should be limited to the conditions outlined under the Electrical Specification Section.

Parameter	Symbol	Min	Max	Unit
Input Voltage (continuous)	V_i	-0.3	15	Vdc
Sequencing Voltage	V_{SEQ}	-0.3	V_i	Vdc
Operating Ambient Temperature (See Thermal Consideration section)	T_o	-40	85*	°C
Storage Temperature	T_{stg}	-55	125	°C

* Derating curves provided in this datasheet end at 85°C ambient temperature. Operation above 85°C ambient temperature is allowed provided the temperatures of the key components do not exceed the limit stated in the Thermal Considerations section.

Electrical Specifications

These specifications are valid over the converter's full range of input voltage, resistive load, and temperature unless noted otherwise.

Input Specifications

Parameter	Symbol	Min	Typical	Max	Unit
Input Voltage	V_i	4.5	-	14	Vdc
Input Current	i_{i_max}	-	-	12	A
Quiescent Input Current ($V_{in} = 12$, $V_o = 3.3V$)	i_{i_Qsnt}	-	55	-	mA
Standby Input Current	i_{i_stdby}	-	1.2	-	mA
Input Reflected-ripple Current, Peak-to-peak (5 Hz to 20 MHz, 1 μ H source impedance)	-	-	40	-	mA _{p-p}
Input Ripple Rejection (120 Hz)	-	-	50	-	dB

Output Specifications

Parameter	Symbol	Min	Typical	Max	Unit
Output Voltage Set Point Tolerance ($V_i = 12$ V; $I_o = I_{o_max}$; $T_a = 25^\circ$ C)	-	-1.5	-	1.5	%
Output Voltage Set Point Tolerance (over all conditions)	-	-2.5	-	2.5	%
Output Regulation:					
Line Regulation ($V_i = 4.5V$ to $14V$, $I_o = 1/2$ of load)	-	-	-	10	mV
Load Regulation ($I_o = I_{o_min}$ to I_{o_max} , $V_i = 12V$)	-	-	-	10	mV
Temperature ($T_a = -40^\circ$ C to 85° C)	-	-	-	5	mV
Output Ripple and Noise Voltage (5 Hz to 20 MHz bandwidth, $V_{in} = 12V$)	Peak-to-peak -	-	50	-	mV
	RMS	-	20	-	mV
External Load Capacitance	-	-	-	1200	μ F
Output Current	I_o	0	-	12	A
Output Current-limit Trip Point (hiccup mode)	I_{o_cli}	I_{omax}	-	24	A
Voltage Tracking/Sequencing Slew Rate – Power UP				2	V/ms
Voltage Tracking/Sequencing Slew Rate – Power down				2	V/ms
Output Ripple Frequency			600		kHz
Turn-on Time ($I_o =$ full load, V_o within 1% of setpoint)	-	-	6	-	ms
Efficiency ($V_i = 12V$; $I_o = I_{o,max}$, $T_A = 25^\circ$ C)	$V_o = 0.59V$	η	74		%
	$V_o = 1.2V$	η	82.5		%
	$V_o = 1.8V$	η	86		%
	$V_o = 2.5V$	η	88.6		%
	$V_o = 3.3V$	η	91		%
	$V_o = 5V$	η	93.3		%



Output Specifications (continued)

Parameter	Symbol	Min	Typical	Max	Unit
Dynamic Response (Vi = 12V; Ta = 25°C; Load transient 2.5A/μs)					
Load step from 100% to 50% of full load:					
Peak deviation			200		mV
Settling time (to 10% band of Vo deviation)			20		μs
Load step from 50% to 100% of full load:					
Peak deviation			200		mV
Settling time (to 10% band of Vo deviation)			20		μs

General Specifications

Parameter	Symbol	Min	Typical	Max	Unit
Remote Enable	-	-	-	-	-
Logic Low:					
ION/OFF = 0μA	VON/OFF	-0.3	-	0.6	V
VON/OFF = 0.0V	ION/OFF	-	-	1.0	μA
Logic High:					
ION/OFF = 1mA	VON/OFF	3.5	-	5	V
Leakage Current	ION/OFF	-	-	10	mA
Calculated MTBF (Telecordia SR-332, 2011, Issue 3), full load, 40°C, 60% upper confidence level, typical Vin			14.5		10 ⁶ -hour
Power Good Signal (open drain, positive logic)	Output LOW threshold	90			%Vonom
	Output HIGH threshold			110	%Vonom
	Pull down resistance of PGOOD pin		7	50	ohm



Characteristic Curves

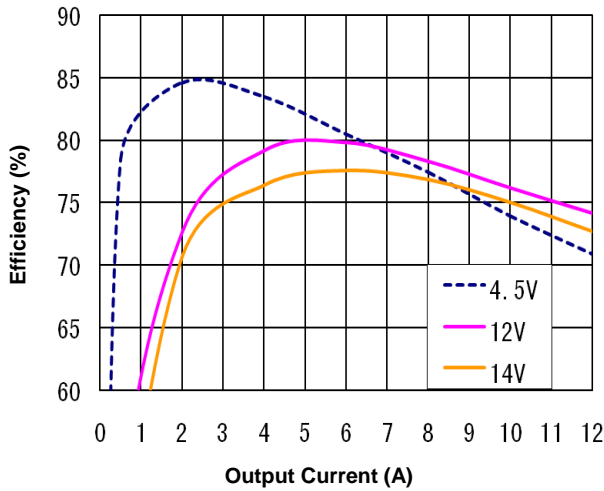

Figure 1(a). Efficiency vs. Load Current
(25°C, 0.591V output)

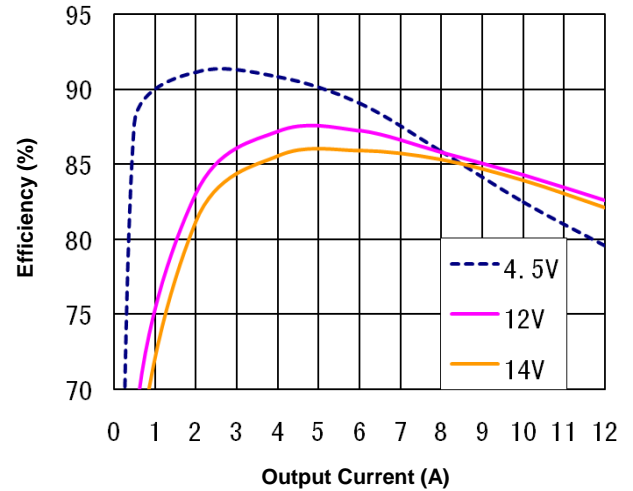

Figure 1(b). Efficiency vs. Load Current
(25°C, 1.2V output)

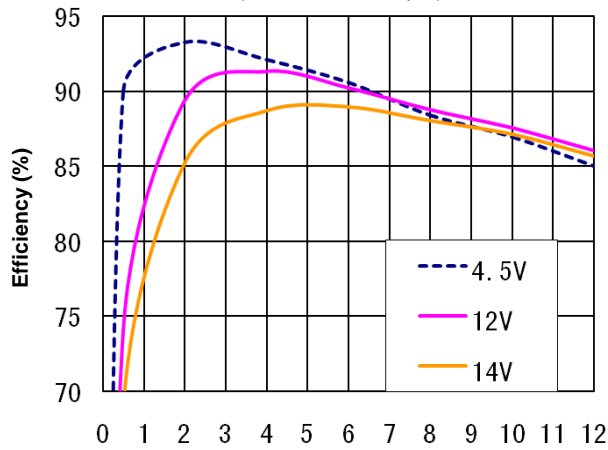

Figure 1(c). Efficiency vs. Load Current
(25°C, 1.8V output)

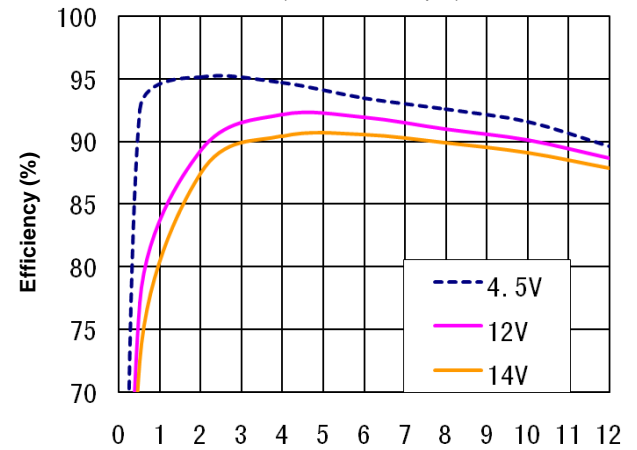

Figure 1(d). Efficiency vs. Load Current
(25°C, 2.5V output)

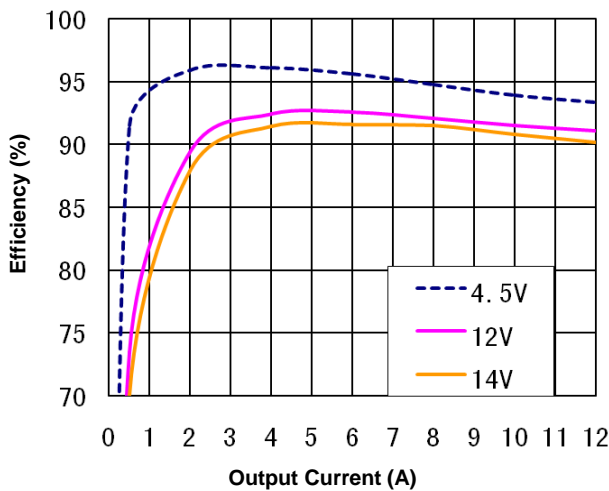

Figure 1(e). Efficiency vs. Load Current
(25°C, 3.3V output)

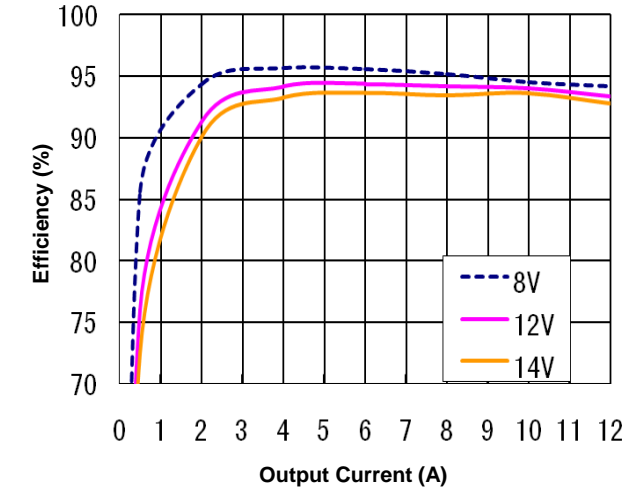
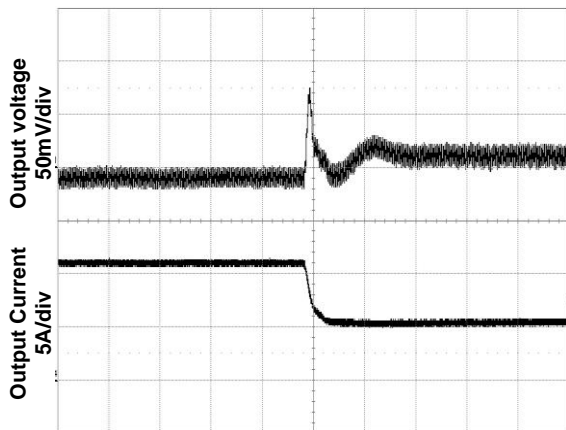
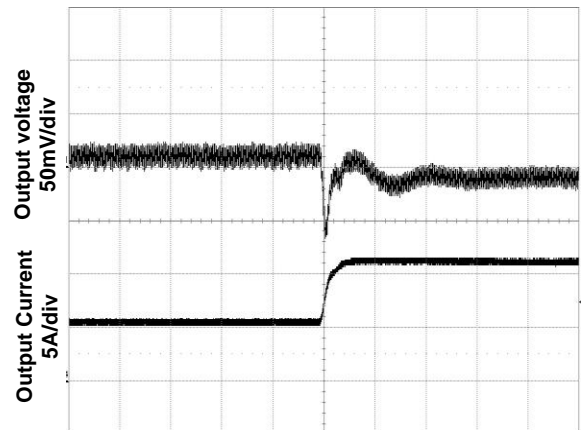

Figure 1(f). Efficiency vs. Load Current
(25°C, 5V output)



Time: 50 us/div

Figure 2. Transient Load Response.
Input voltage 12V, Output voltage 5V, Output current 12A->6A, Slew rate 2.5A/ μ s, Cout-4x220uF



Time: 50 us/div

Figure 3. Transient Load Response.
Input voltage 12V, Output voltage 5V, Output current 6A -> 12A, Slew rate 2.5A/ μ s, Cout-4x220uF

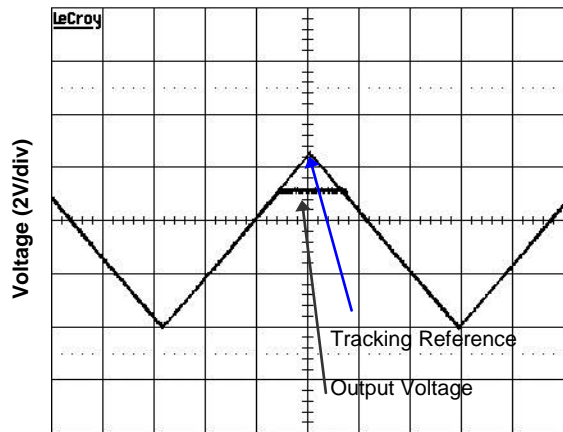

Input Voltage (V)

Figure 4. Voltage Tracking/Sequencing (with tracking option) Vin = 12V, Vo = 5V, Io = 0A

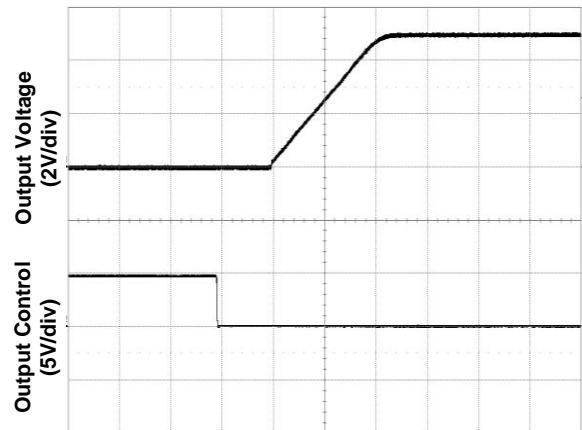

Time: 2 ms/div

Figure 5. Start-Up from Enable Control Vin = 12V, Vo = 5V, Io = 0A

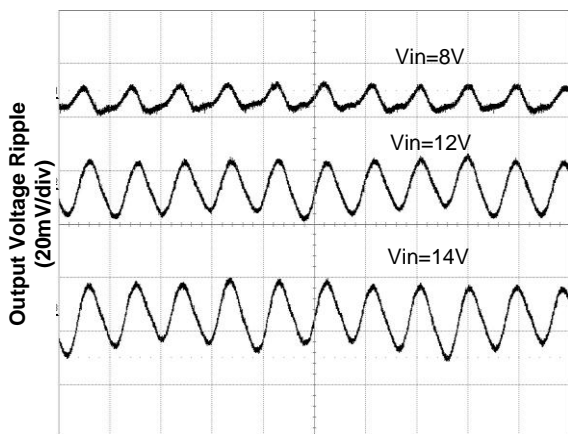

Time: (2 μ s/div)

Figure 6. Output Ripple Voltage Vo = 5V, Io = 12A

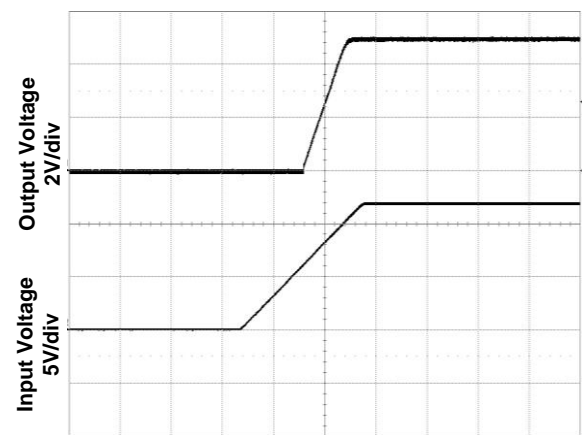

Time: 5 ms/div

Figure 7. Start-Up from Application of Input Voltage Vin = 12V, Vo = 5V, Io = 0A

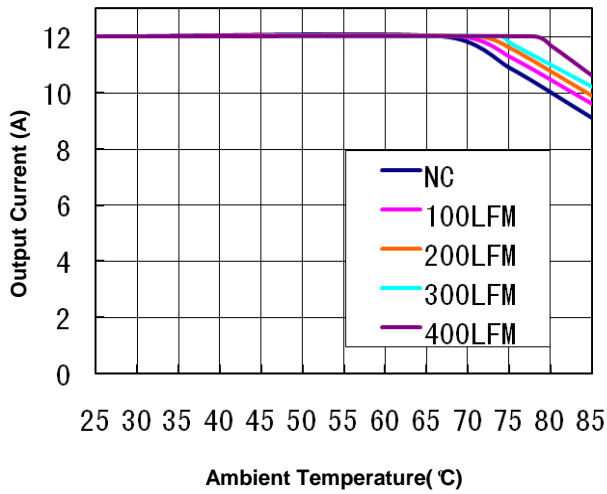

Figure 8(a). Current Derating Curve for 0.59V Output
Vin = 12V, open frame

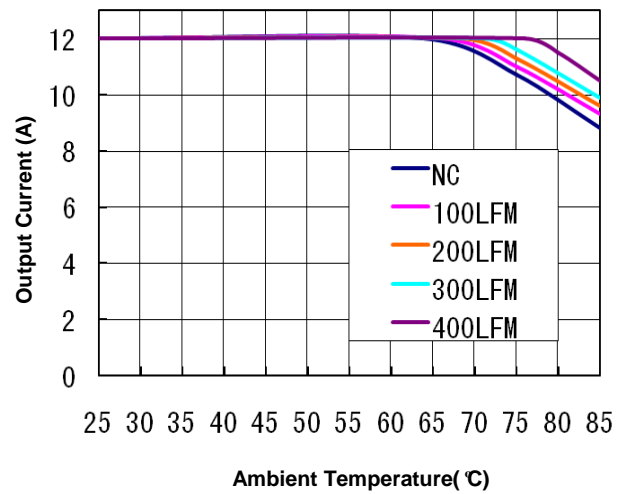

Figure 8(b). Current Derating Curve for 1.2V Output
Vin = 12V, open frame

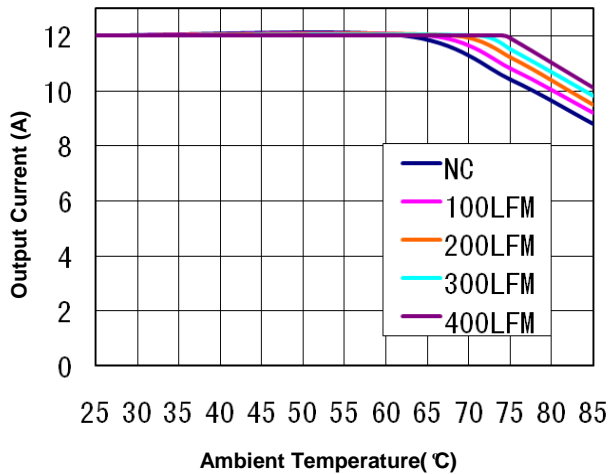

Figure 8(c). Current Derating Curve for 1.8V Output
Vin = 12V, open frame

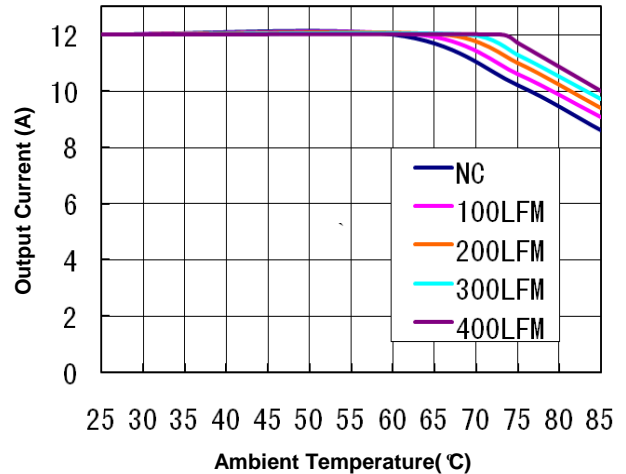

Figure 8(d). Current Derating Curve for 2.5V Output
Vin = 12V, open frame

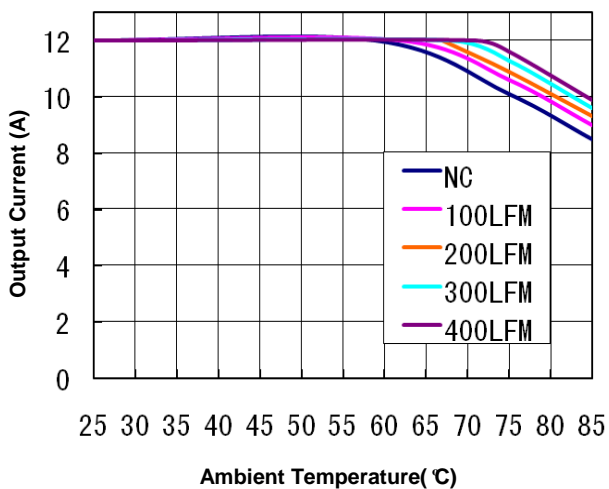

Figure 8(e). Current Derating Curve for 3.3V Output
Vin = 12V, open frame

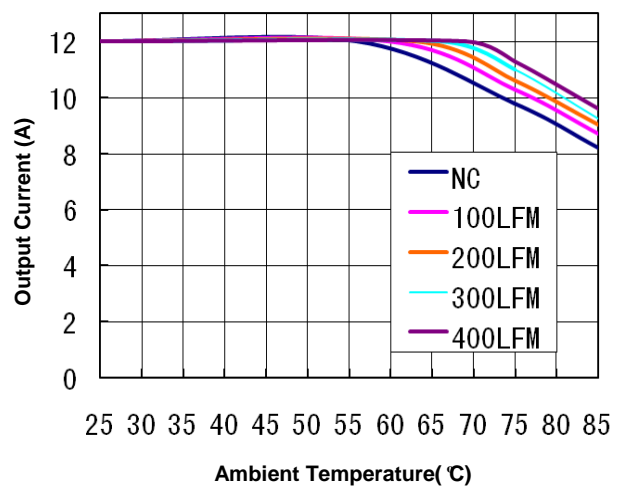

Figure 8(f). Current Derating Curve for 5V Output
Vin = 12V, open frame

Feature Descriptions

Remote ON/OFF

The converter can be turned on and off by changing the voltage or resistance between the ON/OFF pin and GND. The NKS converters can be ordered with positive logic or negative enabling logic.

For the negative control logic, the converter is ON when the ON/OFF pin is at a logic low level, and OFF when the ON/OFF pin is at a logic high level. For the positive control logic, the converter is ON when the ON/OFF pin is at a logic high level and OFF when the ON/OFF pin is at a logic low level. The converter is ON no matter what control logic is when the ON/OFF pin is left open (unconnected).

Figure 9 is the recommended ON/Off control circuit for both positive logic modules and negative logic modules. Recommended value of the pull up resistor $R_{pull-up}$ is 20K. The maximum allowable leakage current from this pin at logic-high level is listed in the General Specifications table.

The logic-low level is from -0.3V to 0.6V, and the maximum current flowing out of ON/OFF pin during logic low is 1 μ A. The external switch must be capable of maintaining a logic-low level while sinking this current.

Figure 10 shows direct logic control. When this method is used, it's important to make sure that the voltage at the ON/OFF pin is less than 0.6V in logic LOW state, and is not lower than 3.5V in logic HIGH state.

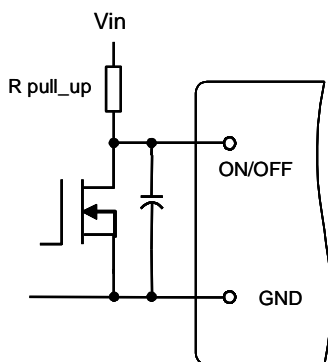

Figure 9. Circuit for Logic Control

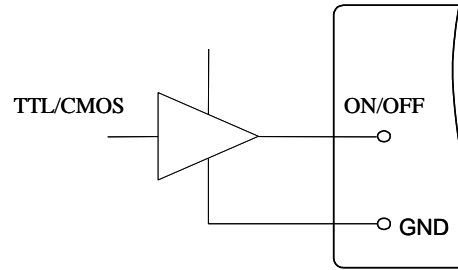

Figure 10. Direct Logic Drive

Remote SENSE

The remote SENSE pin is used to sense voltage at the load point to accurately regulate the load voltage and eliminate the impact of the voltage drop in the power distribution path.

The SENSE pin should be connected to the point where regulation is desired. The voltage between the output pins must not exceed the operating range of this converter shown in the specification table.

When remote sense is not used, the SENSE pin can be connected to the positive output terminals. If the SENSE pins are left floating, the converter will deliver an output voltage slightly higher than its set point.

Since there is no remote sense on the return path, the voltage drop on the ground (common) connection is not compensated, and it is important to make sure that the return path resistance is sufficiently low so that the voltage drop across it is acceptable without compensation.

Output Voltage Programming and Adjustment

This series of converters is available with variable output. The converters are preset to a nominal 0.59V output voltage, and can be trimmed up to 5.5V using an external trim resistor.

To increase the output voltage, a resistor should be connected between the TRIM pin and the GND pin.

$$R_{trim} = \frac{5.91}{V_o - 0.591} (k\Omega)$$

Where V_o is the desired output voltage.

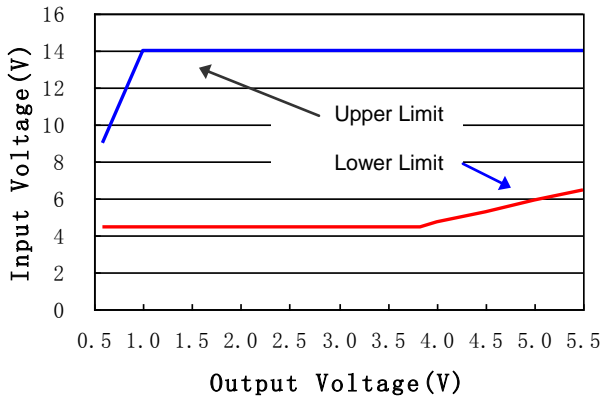

Figure 11. Output Voltage vs. Input Voltage set point area

Figure 11 shows the operating area of the input and output voltages. The Upper Limit curve shows that for output voltages below 0.9V, the input voltage must be lower than the maximum of 14V for the converter to operate properly. The Lower Limit curve shows that for output voltages greater than 3.8V, the input voltage needs to be larger than 4.5V.

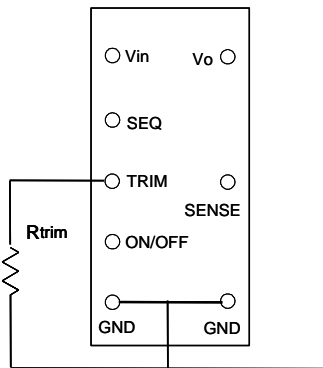

Figure 12. Circuit to Trim Output Voltage.

The circuit configuration for trim operation is shown in Figure 12. Because NKS converters use GND as the reference for control, Rtrim should be placed as close to the GND pin as possible, and the trace connecting the GND pin and Rtrim resistor should not carry significant current, to reduce the effect of voltage drop on the GND trace/plain on the output voltage accuracy.

When the remote sense and the trim functions are used simultaneously, do not allow the output voltage at the converter output terminals to be outside the operating range.

Output Over-Current Protection

As a standard feature, the converter turns off when the load current exceeds the current limit. If the over-current or short circuit condition persists, the converter will operate in a hiccup mode (repeatedly trying to restart) until the over-current condition is cleared.

Thermal Shutdown

As a standard feature, the converter will shut down if an over-temperature condition is detected.

The thermal shutdown function is designed to turn the converter off when the temperature at the controller reaches 140°C. The converter will resume operation after the converter cools down.

Voltage Tracking/Sequencing

An optional voltage tracking/sequencing feature is available. This feature is compatible with DOSA's "Voltage Sequencing" feature and POLA's "Voltage Tracking" feature. If this feature is not used, the SEQ pin should be left open or tied to a voltage higher than the output voltage yet not higher than the input voltage.

During startup, this feature forces the output of the converter to follow the voltage at the SEQ pin on 1:1 ratio until it reaches the set-point. During turnoff, the output voltage follows the voltage at the SEQ pin all the way to the completely shutdown. When using this function, one should pay careful attention to the following aspects:

- 1). This feature is intended mainly for startup and shutdown sequencing control. In normal operation, the voltage at SEQ pin should be maintained higher than the output voltage set point or left unconnected;
- 2). The input voltage should be valid for this feature to work. During startup, it is recommended to have a delay of at least 10 ms between the establishment of a valid input voltage and the application of a voltage at the SEQ pin;
- 3). The ON/OFF pin should be in "Enabled" state when this function is effective.

POWER GOOD

NKS converters provide a Power Good (PGOOD) signal that is implemented with an open-drain output, in which the high state indicates that the output voltage is within 10% of its set point. The PGOOD signal will be at low state if any of the following conditions exist.:

- VFB is more than $\pm 10\%$ from nominal
- soft-start is active
- an under-voltage condition exists
- a short circuit condition has been detected
- die temperature is over 145°C

Design Considerations

Input Source Impedance and Filtering

The stability of the NKS converters, as with any DC/DC converter, may be compromised if the source impedance is too high or too inductive. It's desirable to keep the input source AC impedance as low as possible. To reduce ripple current getting into the input circuit (especially the ground/return conductor), it is desirable to place some low ESR capacitors at the input. Due to the existence of some inductance (such as the trace inductance, connector inductance, etc) in the input circuit, possible oscillation may occur at the input of the converter. A combination of ceramic capacitors and Tantalum/Polymer capacitors should be used at the input so that the relatively higher ESR of Tantalum/Polymer capacitors can help damp the possible oscillation between the ceramic capacitors and the inductance.

Similarly, although the converter is designed to be stable without external capacitor at the output, some low ESR capacitors at the output may be desirable to further reduce the output voltage ripple or improve the transient response. A combination of ceramic capacitors and Tantalum/Polymer capacitors usually achieves good results.

Thermal Considerations

The NKS converters can operate in various thermal environments. Due to high efficiencies and optimal heat distribution, these converters exhibit excellent thermal performance.

The maximum allowable output power of any power converter is usually determined by the electrical design and the maximum operating temperature of its components. The NKS converters have been tested comprehensively under various conditions to generate the derating curves with consideration for long term reliability.

Thermal derating curves are highly influenced by test conditions and the test setup, such as the interface method between the converter and the test fixture board, spacing and construction (especially copper weight, holes and openings) of the fixture board and the spacing board, temperature measurement method, and the ambient temperature measurement point. The thermal derating curves in this datasheet are obtained by thermal tests in a wind tunnel at 25°C, 55°C, 70°C, and 85°C.

Convection heat transfer is the primary cooling means for these converters. Therefore, airflow speed is important for any intended operating environment. Increasing the airflow over the converter enhances the heat transfer via convection.

Figures 8 (a) through (f) show the current derating curves under 12V input voltage for a few output voltages. To maintain high long-term reliability, the module should be operated within these curves in steady state. Note: the Natural convection condition can be measured from 0.05 - 0.15 m/s (10 - 30 LFM).

Mechanical drawing

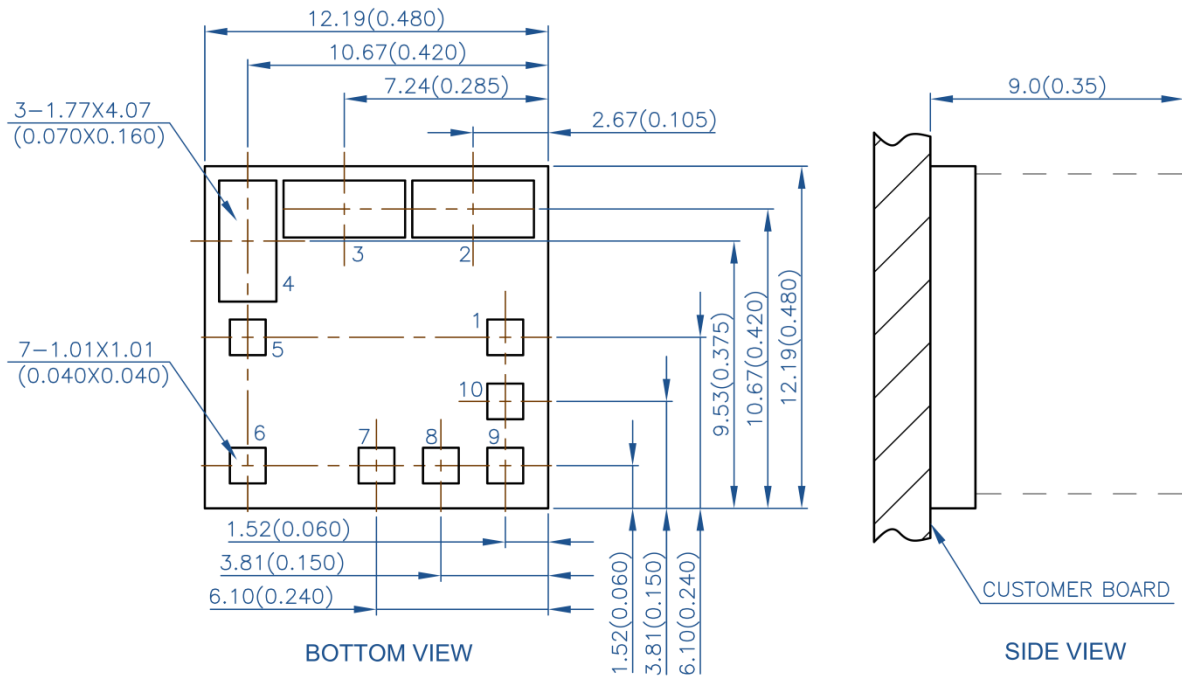

Pin	Name	Function
1	ON/OFF	Remote control
2	Vin	Input voltage
3	GND	Ground
4	Vout	Output voltage
5	SENSE	Remote sense
6	TRIM	Output voltage adjust
7	GND	Ground
8	NC	Not Connect
9	SEQ	Tracking/Sequencing
10	PGOOD	Power Good

Notes:

- All dimensions in mm (inch) (1 inch = 25.4mm).
Tolerances:
.x (.xx): ± 0.5 (0.020")
.xxx: ± 0.25 (0.010")
- Workmanship: Meet or exceeds IPC-A-610 Class II



Recommended Pad Layout

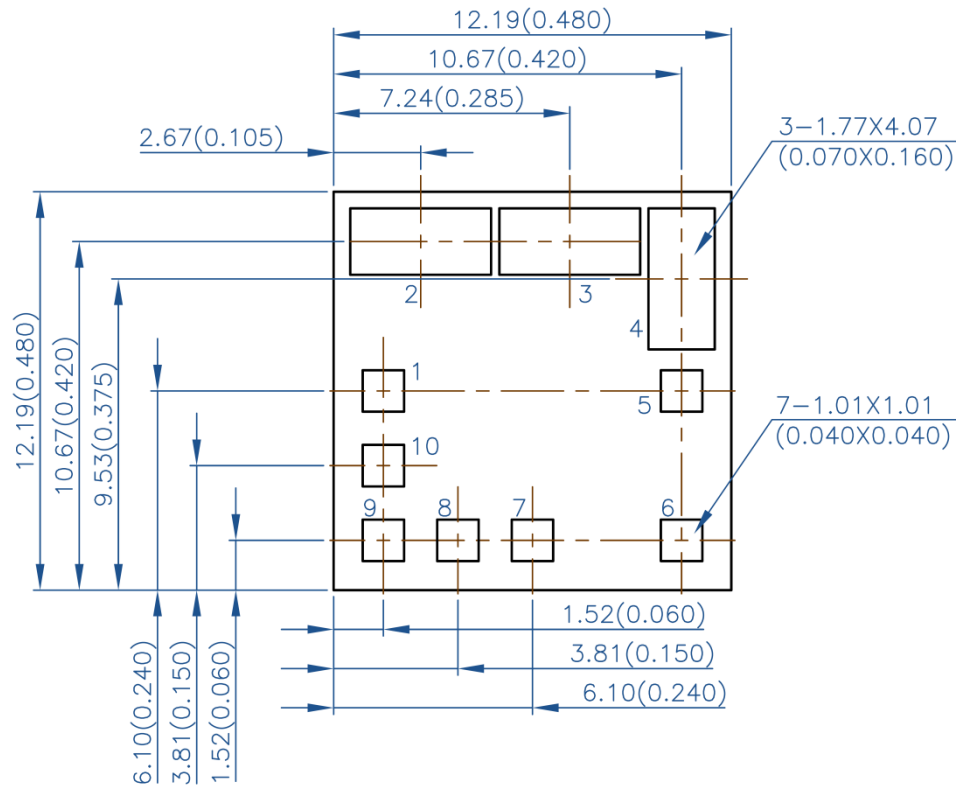

Pin	Name	Function
1	ON/OFF	Remote control
2	Vin	Input voltage
3	GND	Ground
4	Vout	Output voltage
5	SENSE	Remote sense
6	TRIM	Output voltage adjust
7	GND	Ground
8	NC	Not Connect
9	SEQ	Tracking/Sequencing
10	PGOOD	Power Good