

NM180100EVB User Guide

1. Contents

1. Contents	2
2. List of Figures.....	3
3. Introduction.....	4
4. Development Environment	5
4.1. System Requirements.....	5
4.2. Development Toolchains.....	5
4.3. Demonstration Software	5
5. Quick Start	6
5.1. Getting Started	6
6. Hardware Layout and Configuration	10
6.1. Board Layout.....	10
6.2. Mechanical Drawing	11
6.2.1. Mounting Holes Dimensions	11
6.2.2. Connectors Dimensions.....	11
6.3. Power Selection and Current Measurement.....	12
6.3.1. Power Selection	12
6.3.2. Current Measurement	12
6.4. LED Indicators.....	13
6.5. Push-Buttons	13
6.6. Extension Connectors.....	14
6.7. Antenna Characteristics	17
7. Board Fabrication Drawing.....	20
8. Placement Diagram	21
9. Compliance Statements.....	22
9.1. FCC Compliance Statement	22
9.1.1. Part 15.19	22
9.1.2. Part 15.105	22
9.1.3. Part 15.21	22
9.2. ISED Compliance Statement	22
9.2.1. Compliance Statement	22
9.2.2. Déclaration de conformité	22
10. Document Details	23

2. List of Figures

Figure 1 NM180100EVB System Block Diagram	4
Figure 2 Windows Device Manager COM port list.	6
Figure 3 PuTTY serial port configuration.	7
Figure 4 PuTTY session.	8
Figure 5 Serial command console.....	9
Figure 6 NM180100EVB major component board layout.	10
Figure 7 ARDUINO® compatible screw holes.	11
Figure 8 ARDUINO® compatible header connectors.	11
Figure 9 Current measurement connector locations.	12
Figure 10 Reference antenna dimensions. All dimensions are in mm unless otherwise stated.....	17
Figure 11 Reference antenna measured S-parameter.	18
Figure 12 Measured radiation pattern at 915 MHz (left) and at 2440 MHz (right).	18

3. Introduction

The NM180100EVB is designed to showcase the NM180100, a high performance, highly integrated LoRa® Bluetooth® 5 Low Energy Module intended for use in IoT applications. Its programmability makes it ideal for a broad range of wireless applications requiring long range and low power operations. The device combines an RF front end with an ultra-low power sub-threshold CMOS microcontroller.

The NM180100EVB provides an affordable and flexible way for users to try out new concepts and build prototypes with the NM180100 module. The ARDUINO® Shield connectivity support makes it easy to expand the functionality of the NM180100EVB with a wide variety of specialized shields. The NM180100EVB does not require any separate debugging or programming probe as it integrates a SEGGER J-Link OB debugger/programmer with VCOM functionality over a single USB connection.

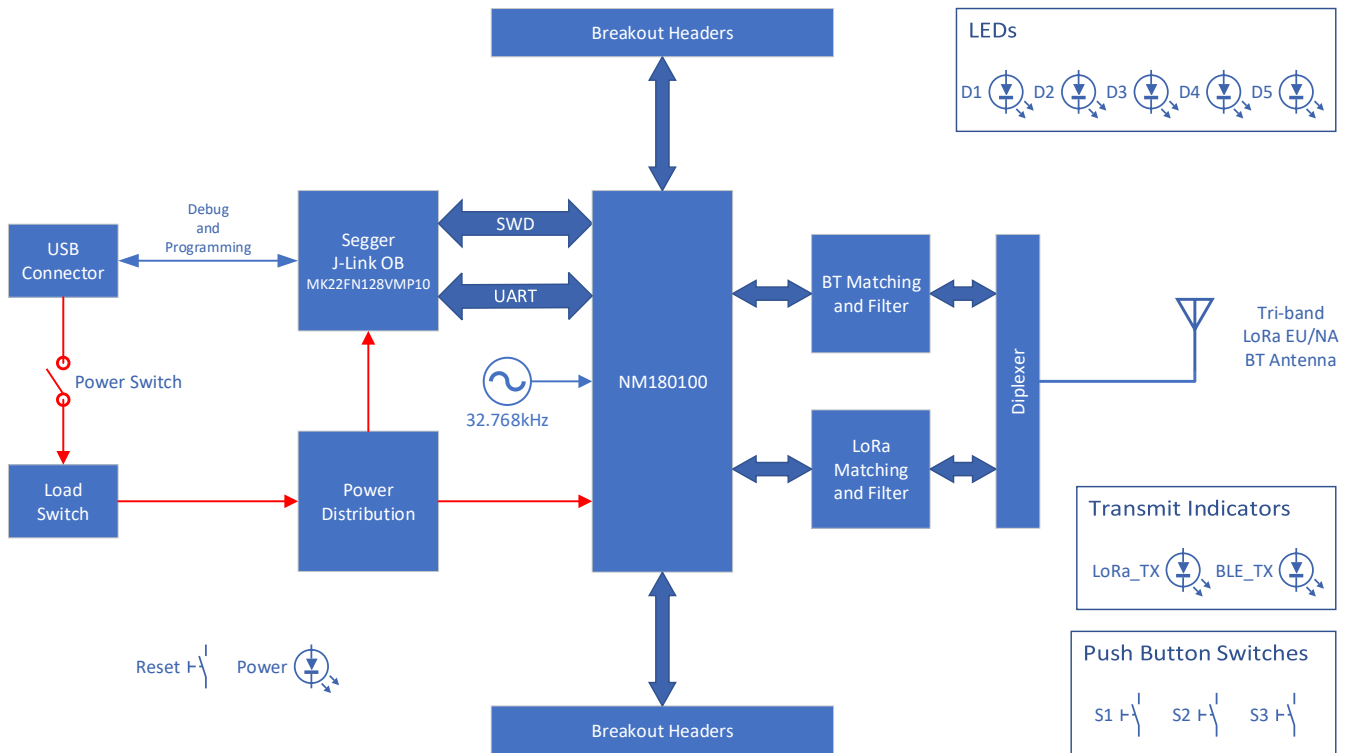

Figure 1 NM180100EVB System Block Diagram

4. Development Environment

4.1. System Requirements

- Windows OS, Linux 64-bit
- USB Type-A to micro-B cable

4.2. Development Toolchains

- Segger J-Link Software
- GNU ARM toolchain from ARM
- Eclipse

4.3. Demonstration Software

The demonstration software of the NM180100EVb is pre-loaded in the NM180100 module. For more information on application and firmware loading, please refer to the software development guide.

5. Quick Start

5.1. Getting Started

1. Install the Segger J-Link Software from:

<https://www.segger.com/downloads/jlink/#J-LinkSoftwareAndDocumentationPack>

prior to connecting the board.

2. Install a terminal emulator such as PuTTY to control the NM180100EVB.
3. Connect the NM180100EVB to a PCB through the USB connector with a USB cable Type-A to Micro-B.
4. Turn on the NM180100EVB using the power switch located beside the USB connector.
5. Take note of the COM port number in Device Manager as shown in Figure 2 (COM4 in this example).

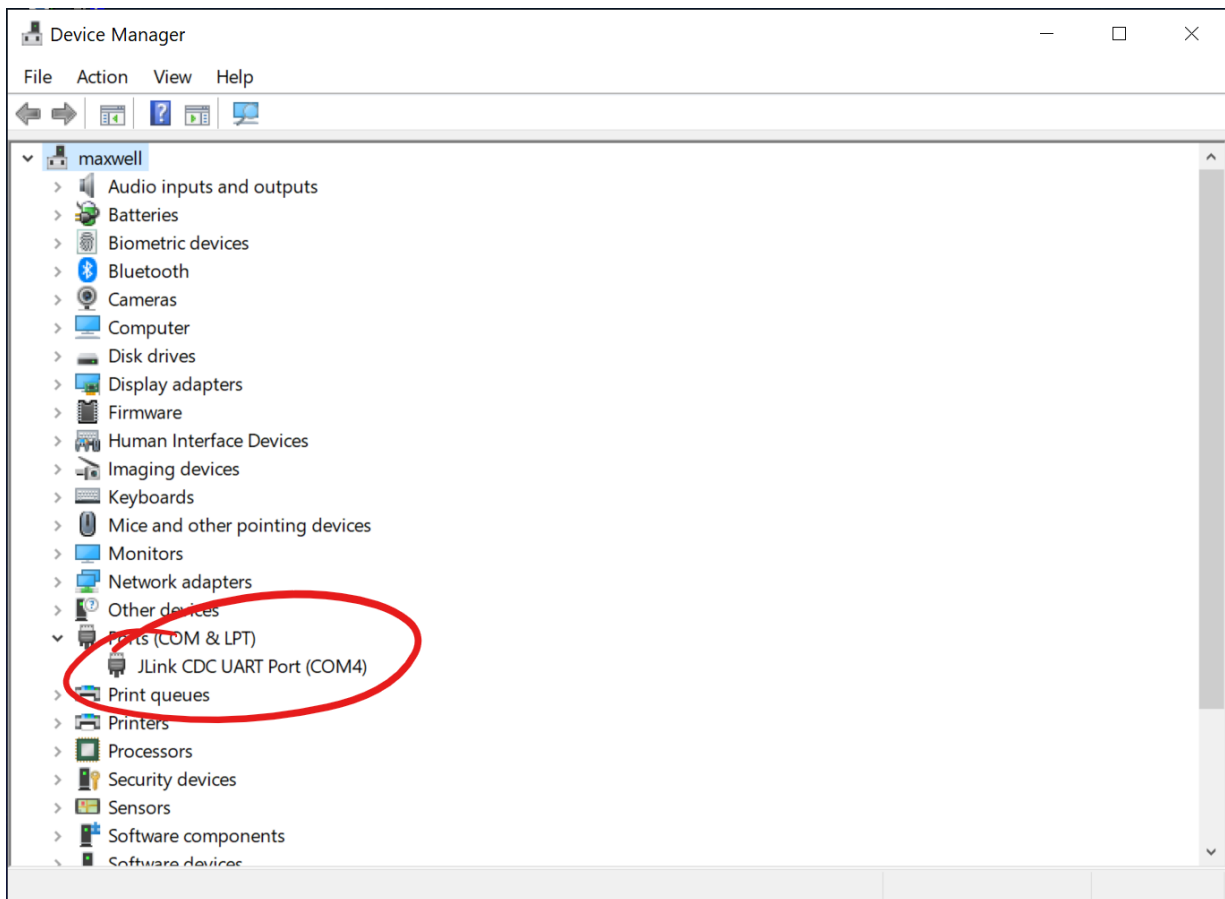

Figure 2 Windows Device Manager COM port list.

6. Enter the following settings into your terminal emulator.

Port	COM4
Baudrate	115200
Data Bits	8
Stop Bits	1
Parity	None
Flow Control	None

In the case of PuTTY, click on Serial under Category as shown in Figure 3.

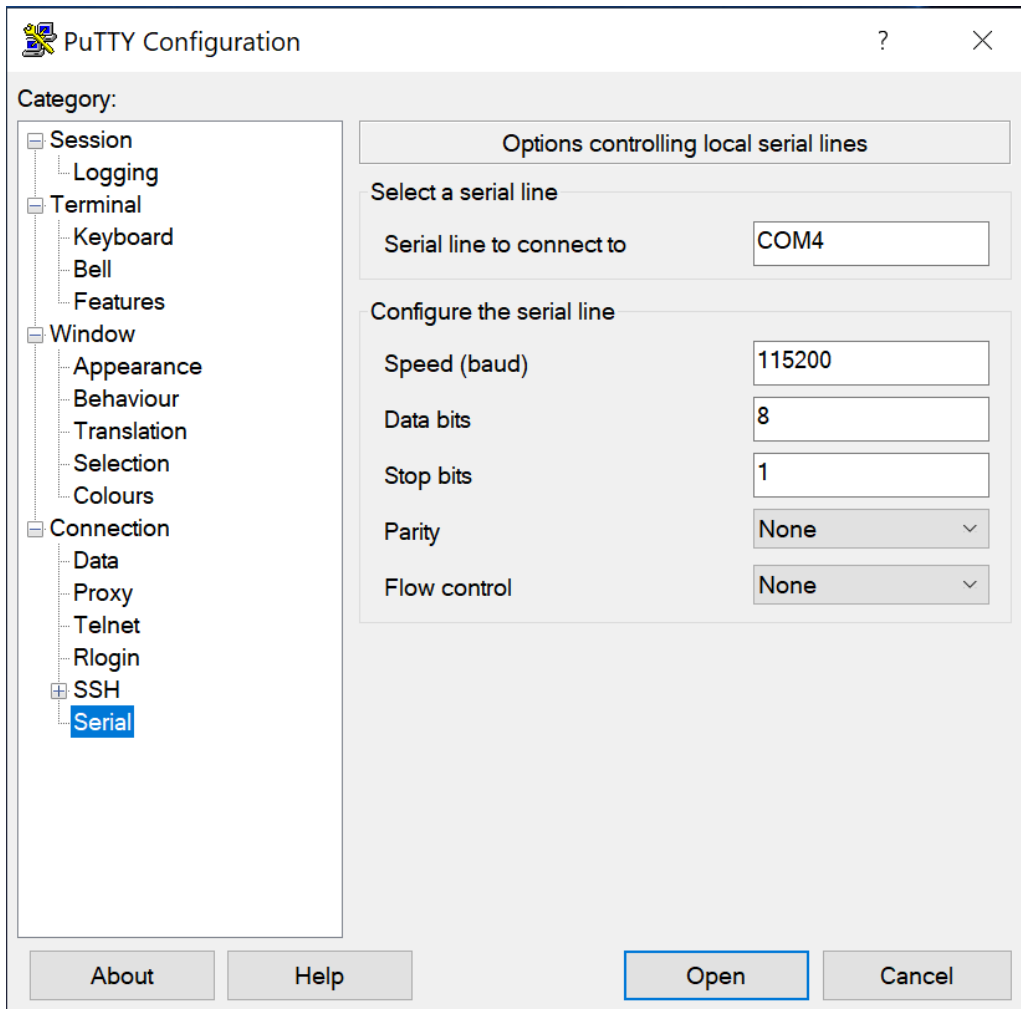

Figure 3 PuTTY serial port configuration.

Optionally, save the session settings to avoid entering the same information each time a connection is made as shown in Figure 4. To create a saved session

- a) click on Session
- b) Enter a name under “Saved Sessions”
- c) Click on the Save button

To load a session, select the session name and then click on the Load button.

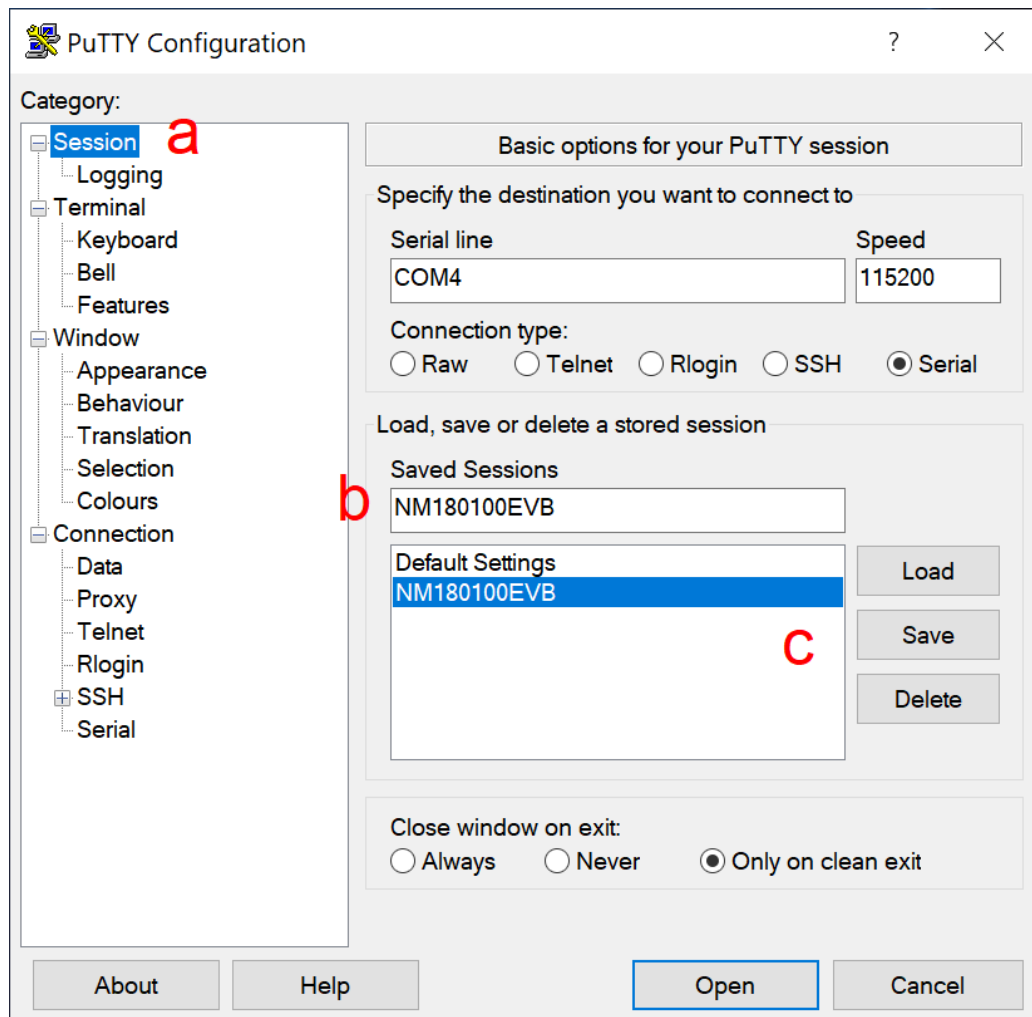
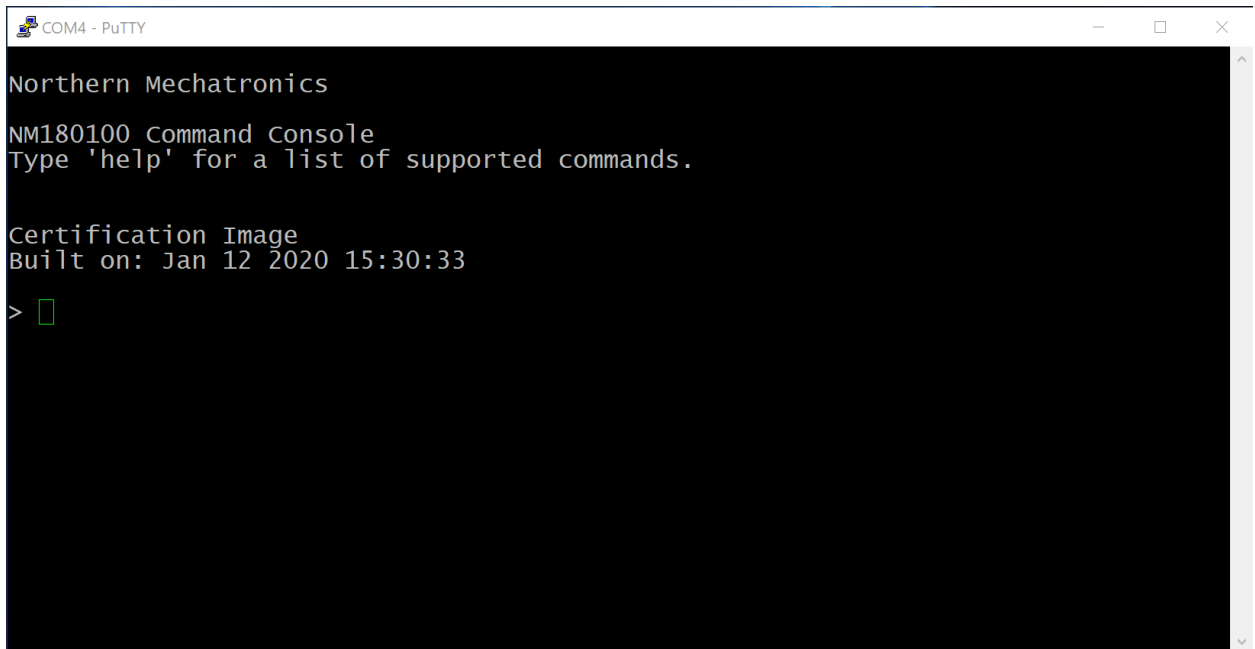

Figure 4 PuTTY session.

7. Press the RESET button on the NM180100EVB, and you will be greeted with a prompt similar what is shown in Figure 5.



```
COM4 - PuTTY
Northern Mechatronics
NM180100 Command Console
Type 'help' for a list of supported commands.

Certification Image
Built on: Jan 12 2020 15:30:33
> █
```

Figure 5 Serial command console.

6. Hardware Layout and Configuration

6.1. Board Layout

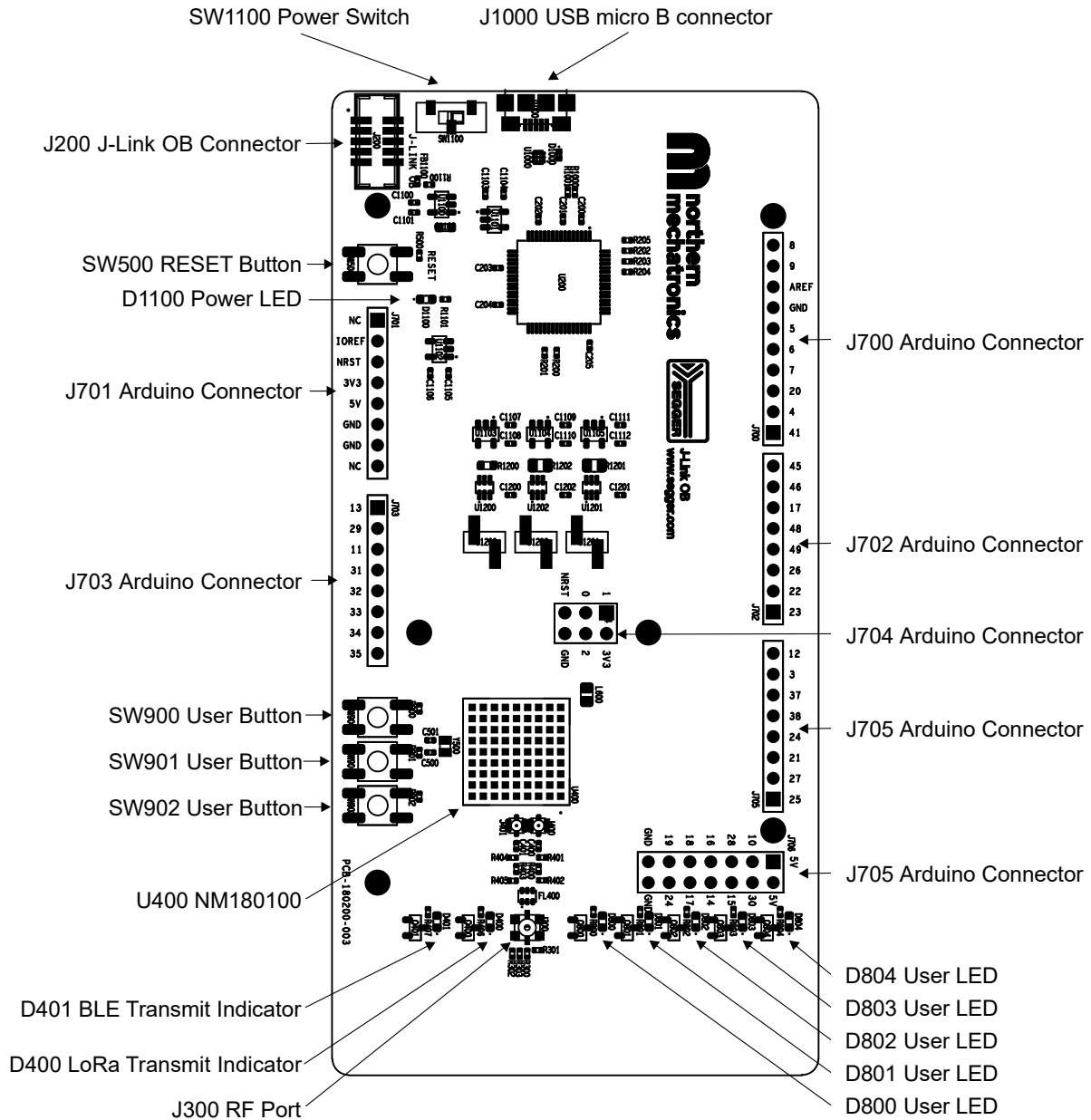

Figure 6 NM180100EVb major component board layout.

6.2. Mechanical Drawing

6.2.1. Mounting Holes Dimensions

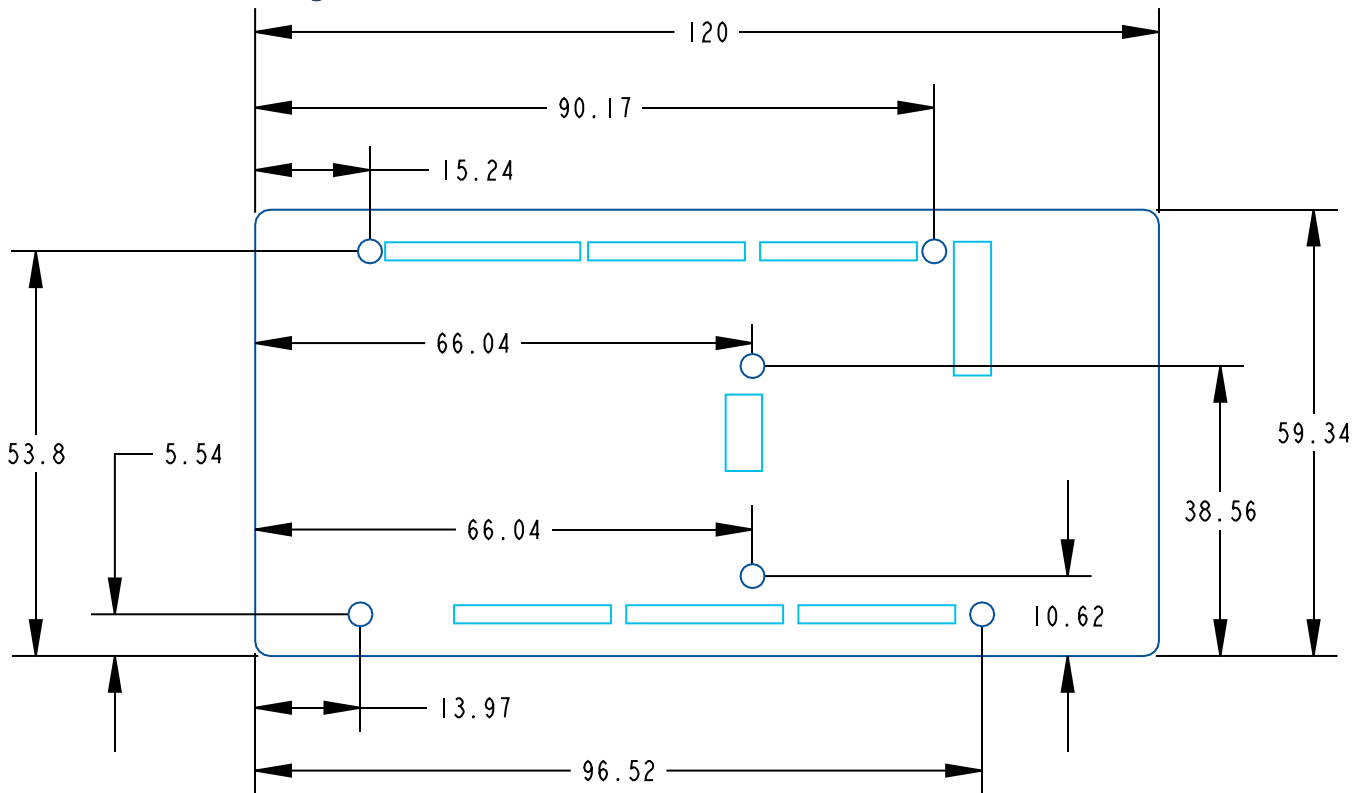

Figure 7 ARDUINO® compatible screw holes.

6.2.2. Connectors Dimensions

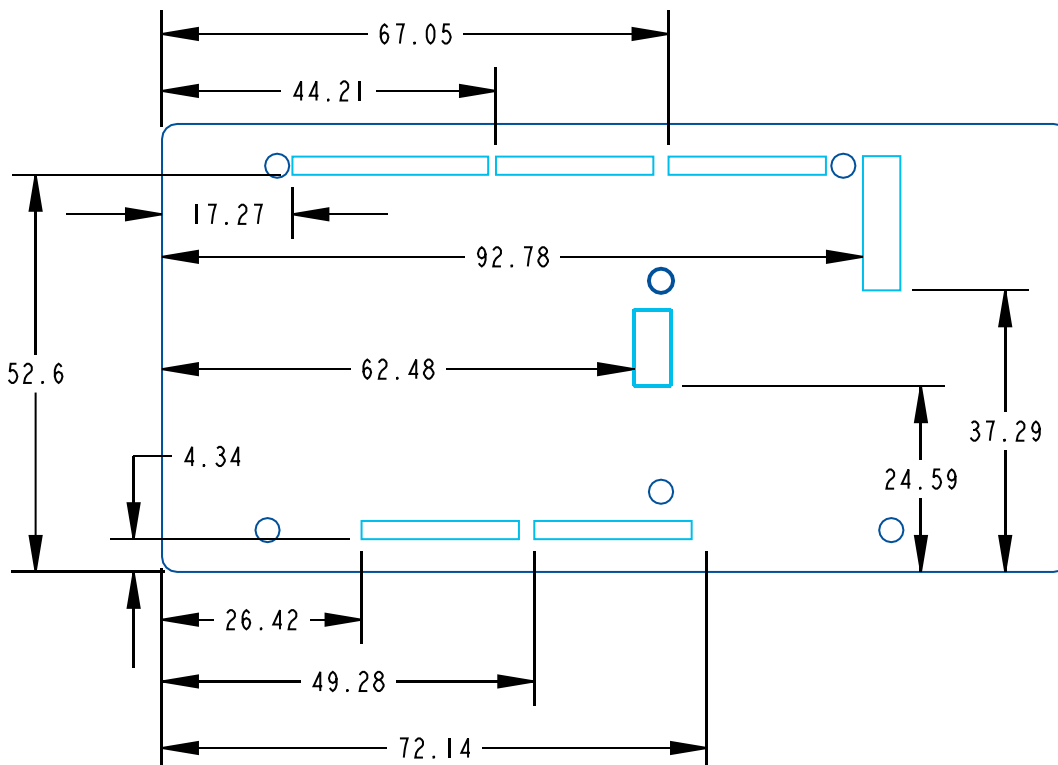

Figure 8 ARDUINO® compatible header connectors.

6.3. Power Selection and Current Measurement

6.3.1. Power Selection

The power supply can be provided by two different sources:

- A host PC connected to J1000 through a USB cable (default setting)
- An external 5V power supply connected to pin 5 of J701.

When both the USB cable and an external 5V power supply are connected, the load switch U1100 will prevent current backflow into the host computer. No such protection is in place for the external 5V connection. As a result, it is imperative that the external 5V voltage be equal to or slightly above the USB VBUS voltage but no more than 5.4V.

Alternatively, pin 5 of J701 could also be used as a power source for any ARDUINO® shields that are plugged into the NM180100EVB; provided that the total current draw does not exceed the maximum output current of the host computer.

6.3.2. Current Measurement

There are three current measurement connections provided on the NM180100EVB. They are used to measure the current consumption of the different power rails of the NM180100. Each measurement circuit consists of a current sense resistor connected to a current sense amplifier via a Kelvin connection. The output of the amplifier is connected to a header pin that facilitates connection external data collection equipment as shown in Figure 9. The measurement range of each connection are shown in Table 1. If a different current measurement range is required, simply replace the resistors with other values.

Table 1 Current measurement connector and resistor values.

Reference Designator	Power Rail	Range	Resistor
J1200	Digital and Analog	Up to approximately 150uA	R1200 23.2 Ohms
J1201	BLE	Up to approximately 150mA	R1201 30 mOhms
J1202	LoRa	Up to approximately 150mA	R1202 30 mOhms

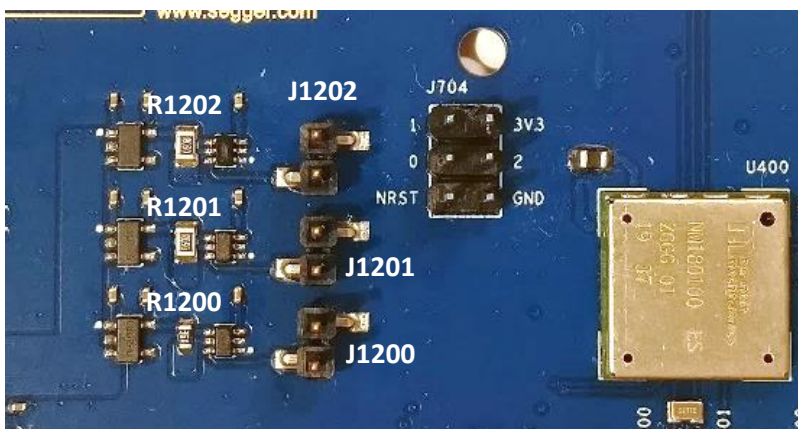

Figure 9 Current measurement connector locations.

6.4. LED Indicators

Table 2 LED connections.

Reference Designator	Description
D1100	The blue LED indicates that the NM180100EVB is powered on and +5V power is available on pin 5 of J701.
D400	The green LED indicates that the LoRa radio in the NM180100 is transmitting.
D401	The blue LED indicates that the BLE radio in the NM180100 is transmitting.
D800	The orange LED is connected to pin B8 of the NM180100 corresponding GPIO17.
D801	The orange LED is connected to pin C3 of the NM180100 corresponding GPIO14.
D802	The orange LED is connected to pin G7 of the NM180100 corresponding GPIO15.
D803	The orange LED is connected to pin D2 of the NM180100 corresponding GPIO30.
D804	The orange LED is connected to pin E1 of the NM180100 corresponding GPIO10.

6.5. Push-Buttons

Table 3 Push buttons connections.

Reference Designator	Description
SW500	This push button is connected to NRST of J701 (pin 3), J704 (pin 5), and NRESET of the NM180100. It is used to reset the NM180100.
SW900	This user button is connected to pin C8 of the NM180100 corresponding GPIO16.
SW901	This user button is connected to pin A9 of the NM180100 corresponding GPIO18.
SW902	This user button is connected to pin D8 of the NM180100 corresponding GPIO19.

6.6. Extension Connectors

The following diagram shows the signals connected by the NM180100EVB extension connectors, including the support for ARDUINO® Mega. J700, J701, J702, J703, J705, and J706 are female connectors whereas J704 is a male connector. Most shields designed for ARDUINO® Mega or ARDUINO® Uno V3 can fit the NM180100EVB board.

WARNING: The I/Os of the NM180100 are 3.3V compatible instead of 5V for ARDUINO®.

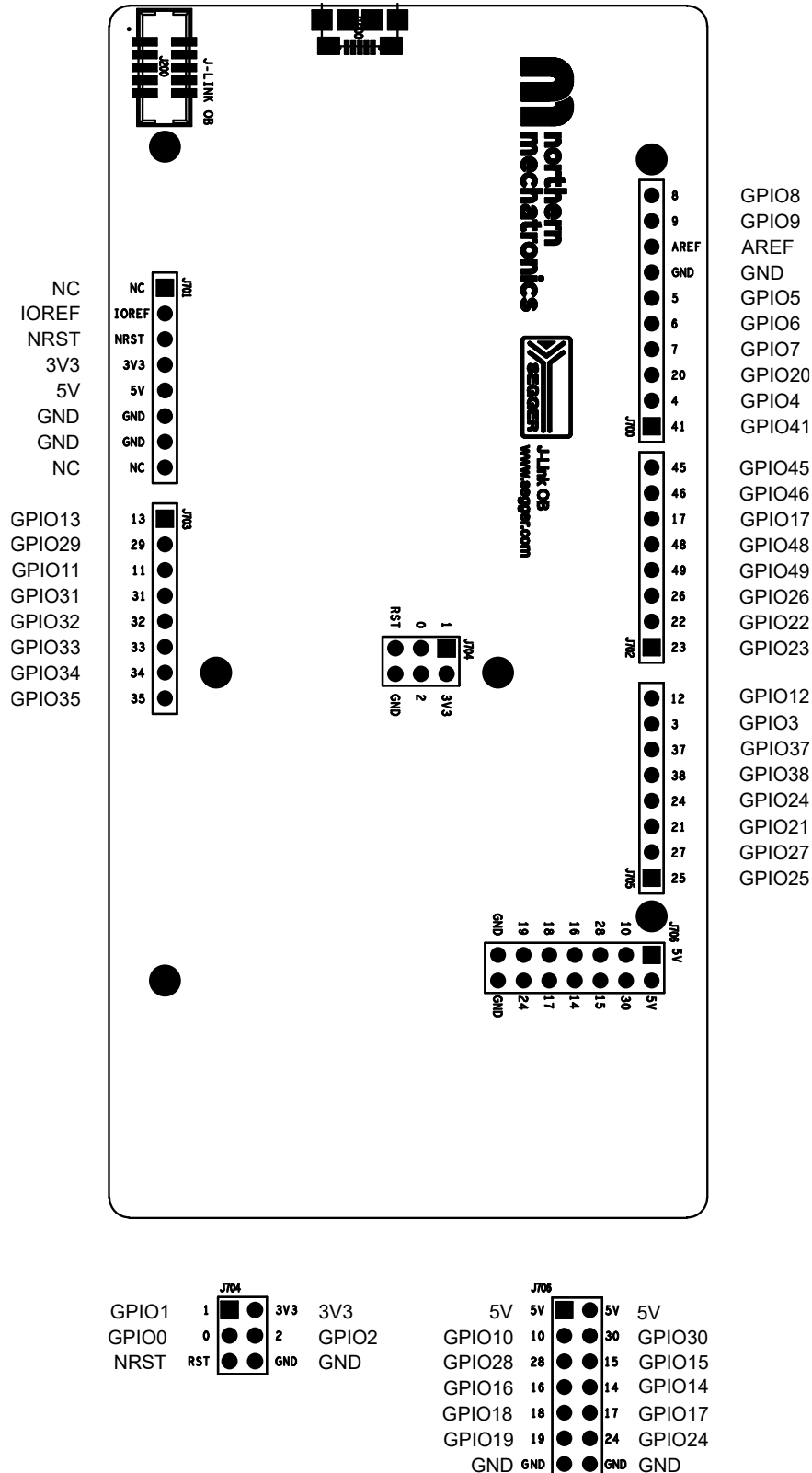

Connector	Pin	Signal Name	Function
J700	1	GPIO41	NCE41/BLEIF_IRQ/SWO/GPIO41/I2S_WCLK/UA1RTS/UART0TX/UA0RTS SWO
	2	GPIO4	UA0CTS/SLINT/NCE4/GPIO04/UART1RX/CT17/MSPI2
	3	GPIO20	SWDCK/GPIO20/UART0TX/UART1TX/I2S_BCLK/UA1RTS Default to SWDCK
	4	GPIO7	NCE7/M0MOSI/CLKOUT/GPIO07/TRIG0/UART0TX/CT19
	5	GPIO6	M0SDAWIR3/M0MISO/UA0CTS/GPIO06/CT10/I2S_DAT
	6	GPIO5	M0SCL/M0SCK/UA0RTS/GPIO05/CT8
	7	GND	Ground
	8	AREF	
	9	GPIO9	M1SDAWIR/M1MISO/NCE9/GPIO09/SCCIO/UART1RX
	10	GPIO8	M1SCL/M1SCK/NCE8/GPIO08/SCCCLK/UART1TX
J701	1	NC	
	2	IOREF	3.3V Ref
	3	NRST	Reset
	4	3V3	3.3V output
	5	5V	5V input/output
	6	GND	Ground
	7	GND	Ground
	8	NC	
J702	1	GPIO23	UART0RX/NCE23/CT14/GPIO23/I2S_WCLK/CMPOUT/MSPI3
	2	GPIO22	UART0TX/NCE22/CT12/GPIO22/PDM_CLK/MSPI0/SWO
	3	GPIO26	NCE26/CT3/GPIO26/SCCRST/MSPI1/UART0TX/UA1CTS
	4	GPIO49	UART0RX/NCE49/CT30/GPIO49/M5SDAWIR3/M5MISO
	5	GPIO48	UART0TX/NCE48/CT28/GPIO48/M5SCL/M5SCK
	6	GPIO17	CMPRF1/NCE17/TRIG1/GPIO17/SCCCLK/UART0RX/UA1CTS
	7	GPIO46	I2S_BCLK/NCE46/CT24/GPIO46/SCCRST/PDM_CLK/UART1TX/SWO
	8	GPIO45	UA1CTS/NCE45/CT22/GPIO45/I2S_DAT/PDM_DATA/UART0RX/SWO
J703	1	GPIO13	ADC0D0PSE8/NCE13/CT2/GPIO13/I2S_BCLK/UA0RTS/UART1RX
	2	GPIO29	ADCSE1/NCE29/CT9/GPIO29/UA0CTS/UA1CTS/UART0RX/PDM_DATA
	3	GPIO11	ADCSE2/NCE11/CT31/GPIO11/SLINT/UA1CTS/UART0RX/PDM_DATA
	4	GPIO31	ADCSE3/NCE31/CT13/GPIO31/UART0RX/SCCCLK/UA1RTS
	5	GPIO32	ADCSE4/NCE32/CT15/GPIO32/SCCIO/UA1CTS
	6	GPIO33	ADCSE5/NCE33/32KHZ_XT/GPIO33/UA0CTS/CT23/SWO
	7	GPIO34	ADCSE6/NCE34/UA1RTS/GPIO34/CMPRF2/UA0RTS/UART0RX/PDM_DATA
	8	GPIO35	ADCSE7/NCE35/UART1TX/GPIO35/I2S_DAT/CT27/UA0RTS
J704	1	GPIO1	SLSDAWIR3/SLMOSI/UART0TX/GPIO01/MSPI5/NCE1
	2	3V3	
	3	GPIO0	SLSCL/SLSCK/CLKOUT/GPIO00/MSPI4/NCE0
	4	GPIO2	UART1RX/SLMISO/UART0RX/GPIO02/MSPI6/NCE2
	5	NRST	Reset
	6	GND	Ground

J705	1	GPIO25	UART1RX/NCE25/CT1/GPIO25/M2SDAWIR3/M2MISO
	2	GPIO27	UART0RX/NCE27/CT5/GPIO27/M2SCL/M2SCK
	3	GPIO21	SWDIO/GPIO21/UART0RX/UART1RX/SCCRST/UA1CTS SWDIO
	4	GPIO24	UART1TX/NCE24/MSPI8/GPIO24/UA0CTS/CT21/32KHZ_XT/SWO
	5	GPIO38	TRIG3/NCE38/UA0CTS/GPIO38/M3MOSI/UART1RX
	6	GPIO37	TRIG2/NCE37/UA0RTS/GPIO37/SCCIO/UART1TX/PDM_CLK/CT29
	7	GPIO3	UA0RTS/SLnCE/NCE3/GPIO03/MSPI7/TRIG1/I2S_WCLK
	8	GPIO12	ADCD0NSE9/NCE12/CT0/GPIO12/SLnCE/PDM_CLK/UA0CTS/UART1TX
J706	1	5V	
	2	5V	
	3	GPIO10	UART1TX/M1MOSI/NCE10/GPIO10/PDM_CLK/UA1RTS
	4	GPIO30	NCE30/CT11/GPIO30/UART0TX/UA1RTS/BLEIF_SCK/I2S_DAT
	5	GPIO28	I2S_WCLK/NCE28/CT7/GPIO28/M2MOSI/UART0TX
	6	GPIO15	ADCD1N/NCE15/UART1RX/GPIO15/PDM_DATA/EXTXT/SWDIO/SWO
	7	GPIO16	ADCSE0/NCE16/TRIG0/GPIO16/SCCRST/CMPIN0/UART0TX/UA1RTS
	8	GPIO14	ADCD1P/NCE14/UART1TX/GPIO14/PDM_CLK/EXTHFS/SWDCK/32KHz_XT
	9	GPIO18	CMPIN1/NCE18/CT4/GPIO18/UA0RTS/ANATEST2/UART1TX/SCCIO
	10	GPIO17	CMPRF1/NCE17/TRIG1/GPIO17/SCCCLK/UART0RX/UA1CTS
	11	GPIO19	CMPRF0/NCE19/CT6/GPIO19/SCCCLK/ANATEST1/UART1RX/I2S_BCLK
	12	GPIO24	UART1TX/NCE24/MSPI8/GPIO24/UA0CTS/CT21/32KHz_XT/SWO
	13	GND	Ground
	14	GND	Ground

6.7. Antenna Characteristics

The reference antenna on the NM180100EVB is a tri-band PIFA type antenna supporting the unlicensed band operation in Europe from 862MHz to 868MHz and North America from 902MHz to 928MHz; as well as BLE in the 2.4GHz band. The exact dimensions of the antenna and PCB substrate stackup can be obtained from the board fabrication package available for download at <https://www.northernmechatronics.com/nm180100>.

The S-parameter measurement is shown in Figure 11. As shown in the plot, the antenna is designed to exhibit high return loss outside of the operating bands that further suppresses spurious radiated emissions.

Finally, the measured radiation pattern and the gain table are shown in Figure 12 and Table 4 respectively.

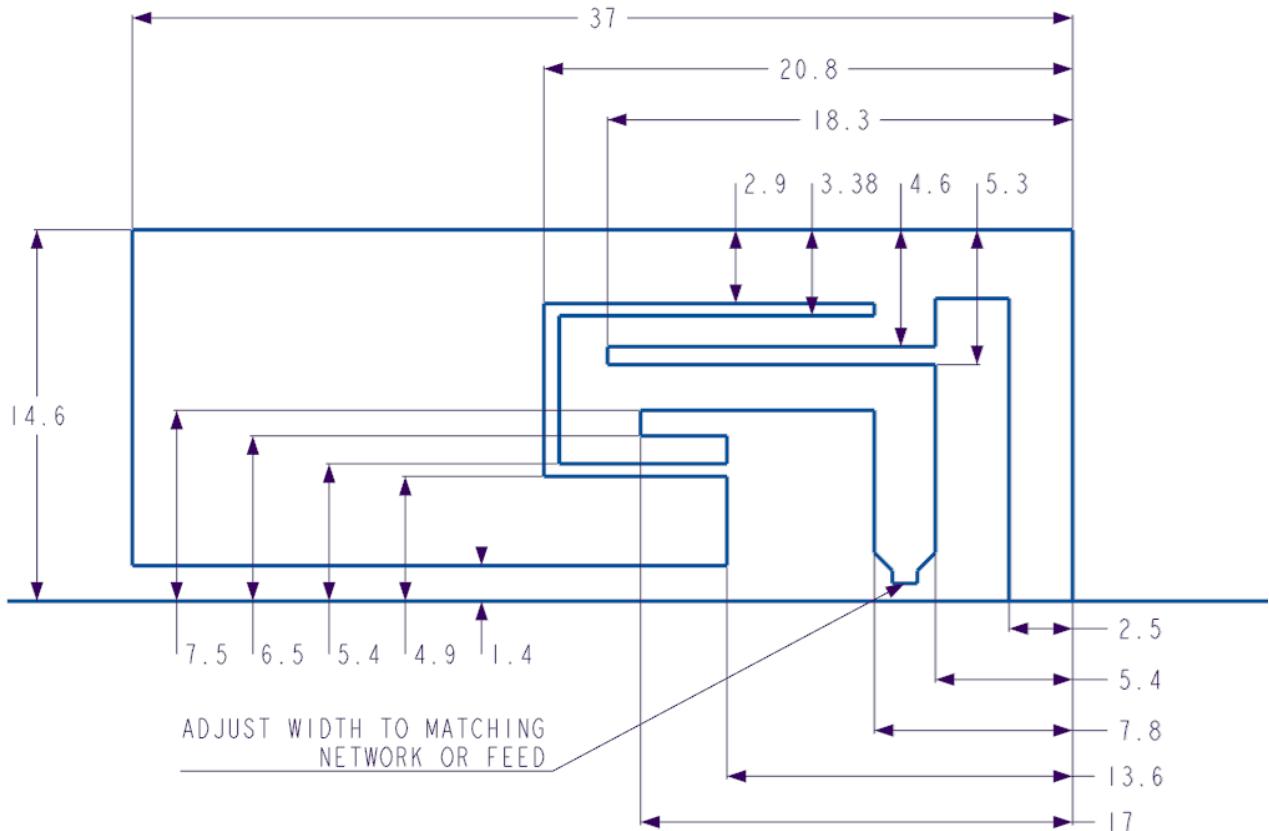

Figure 10 Reference antenna dimensions. All dimensions are in mm unless otherwise stated.

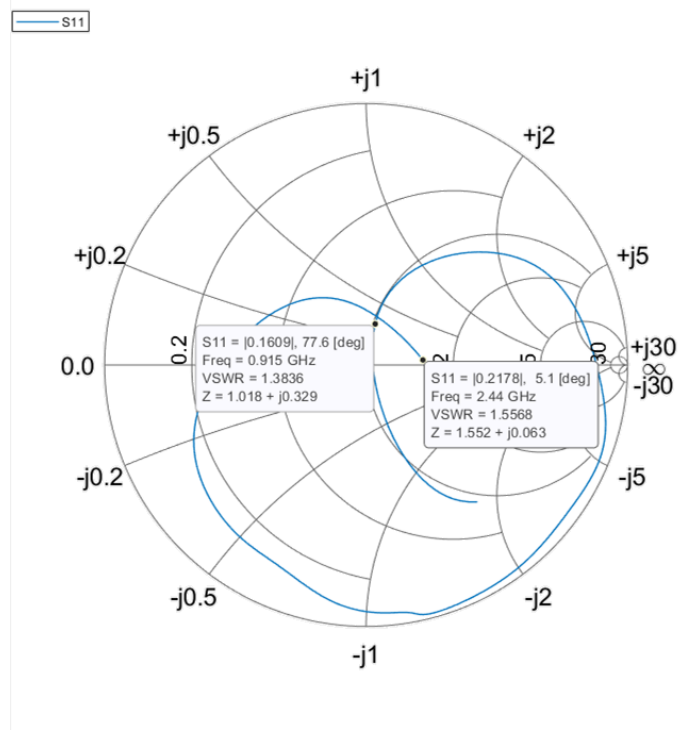

Figure 11 Reference antenna measured S-parameter.

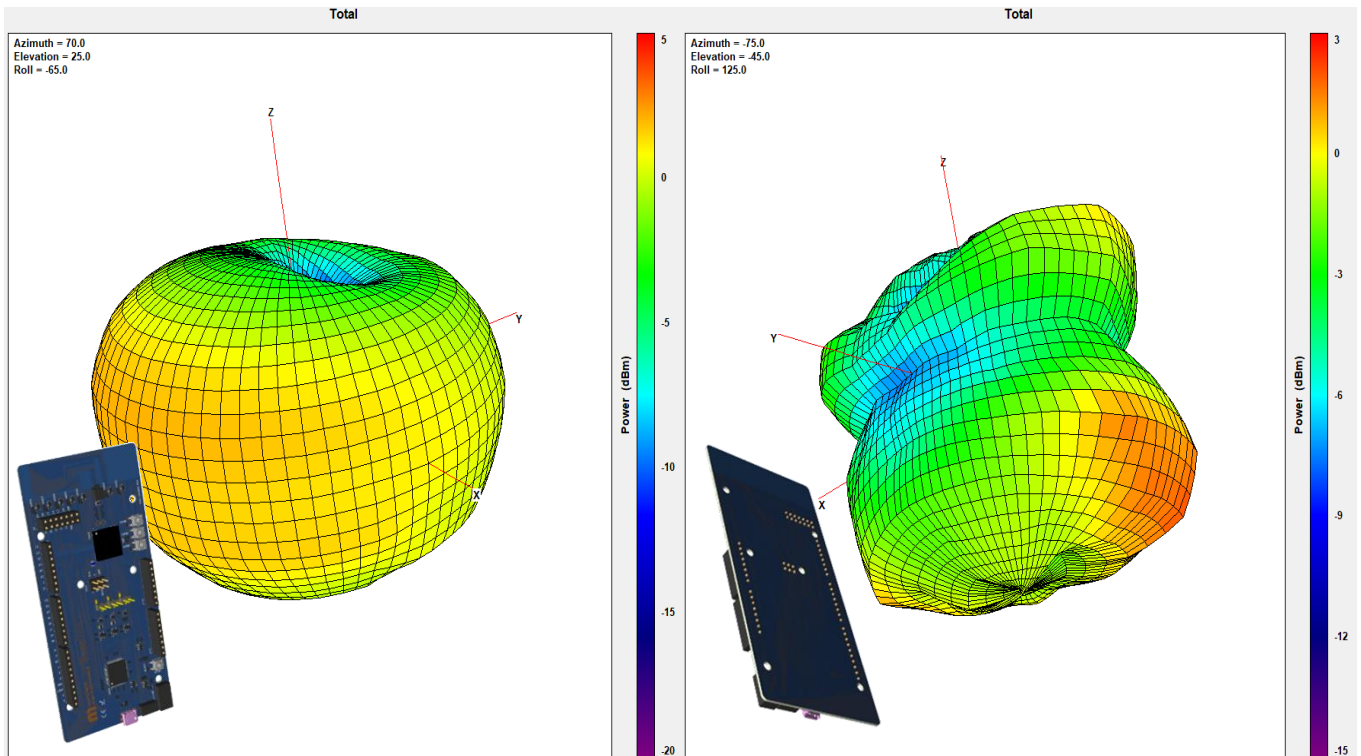
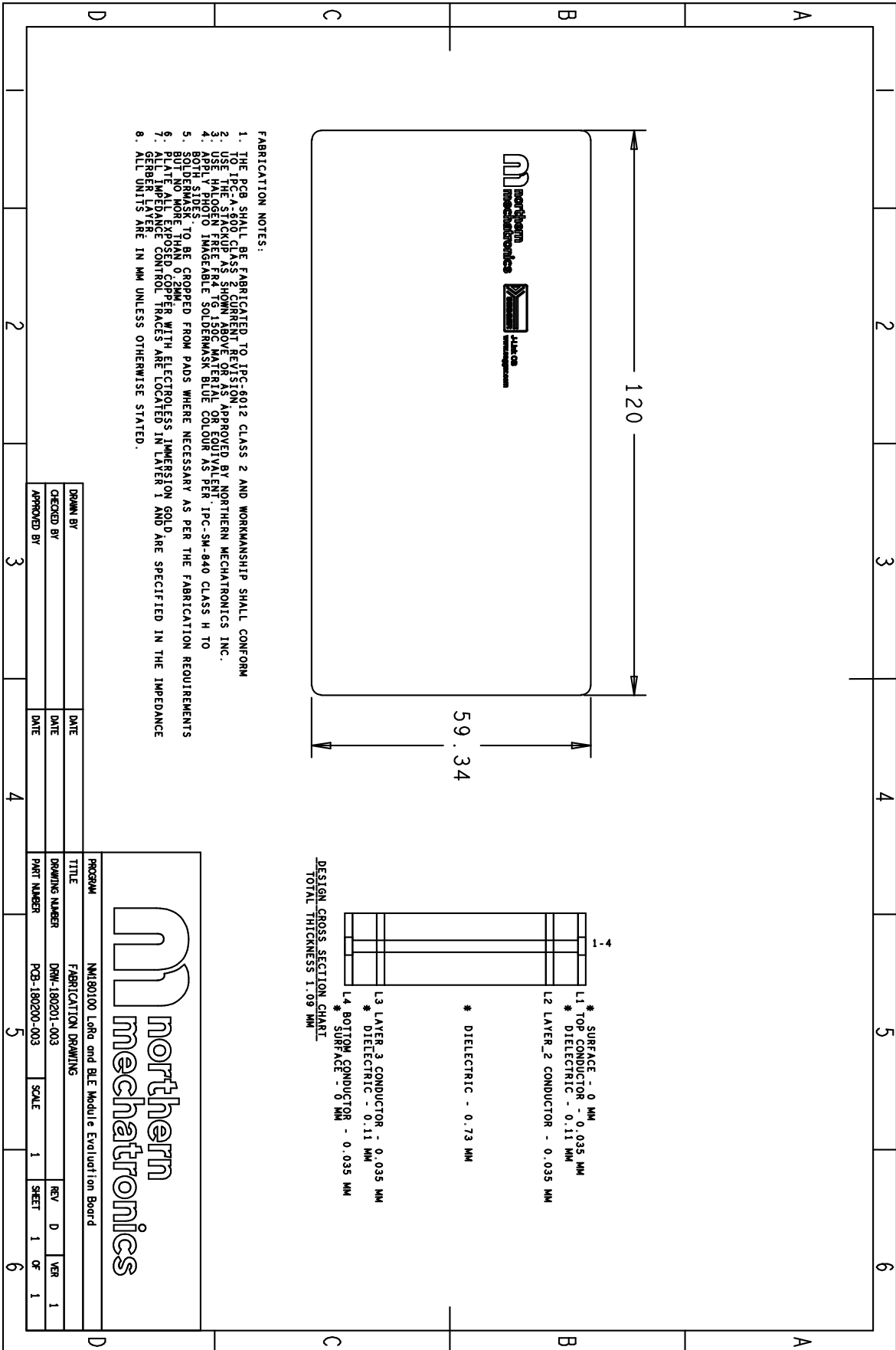

Figure 12 Measured radiation pattern at 915 MHz (left) and at 2440 MHz (right).

Table 4 Antenna performance summary across frequencies.

Band	Peak Gain (dBi)	Average Gain (dBi)	Directivity (dBi)
915 ISM	2.27	-0.47	2.74
BLE	2.26	-1.92	4.18

7. Board Fabrication Drawing



8. Placement Diagram

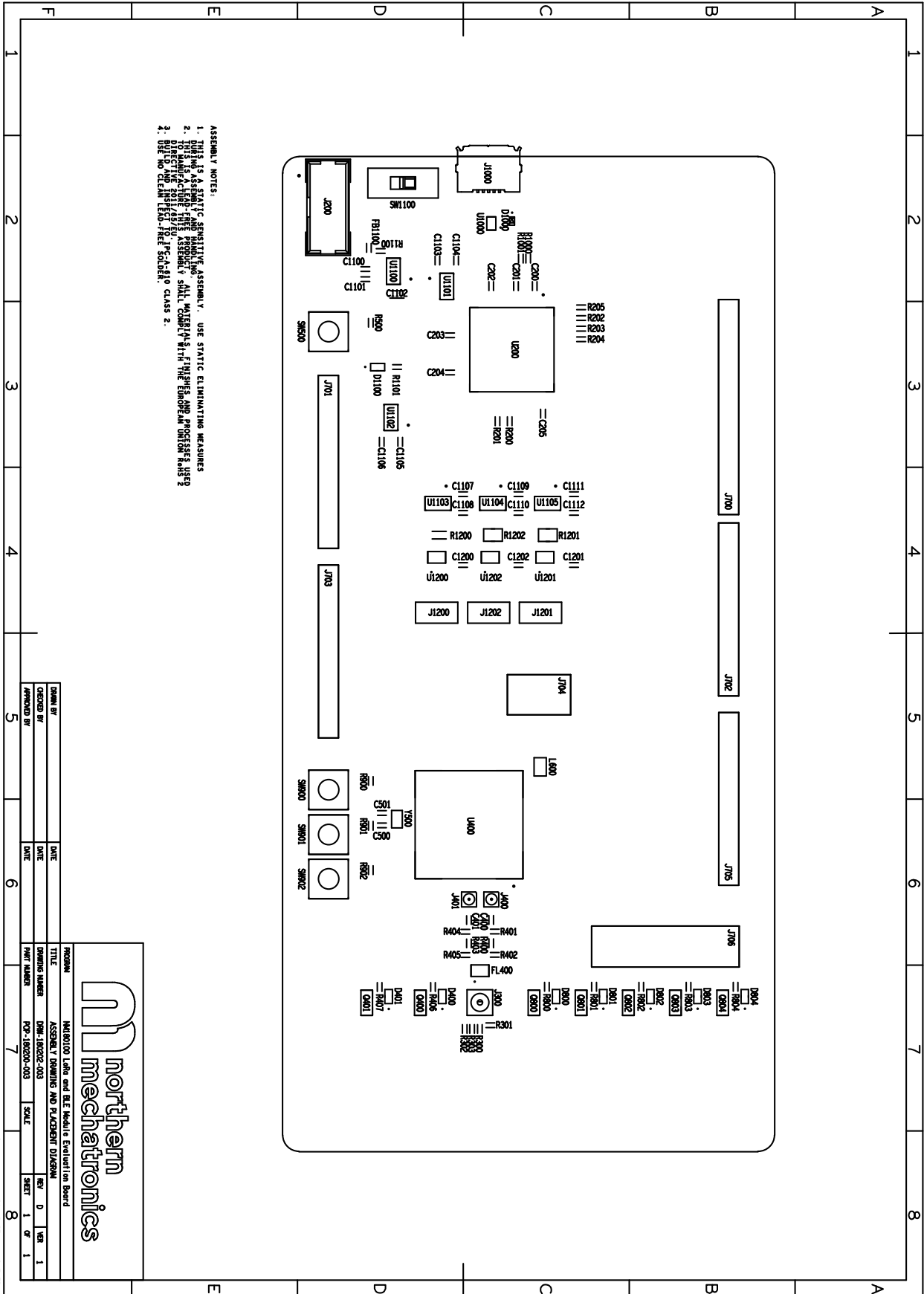

9. Compliance Statements

9.1. FCC Compliance Statement

9.1.1. Part 15.19

This device complies with Part 15 of the FCC Rules. Operation is subject to the following two conditions: (1) this device may not cause harmful interference, and (2) this device must accept any interference received, including interference that may cause undesired operation.

9.1.2. Part 15.105

This equipment has been tested and found to comply with the limits for a Class A digital device, pursuant to part 15 of the FCC Rules. These limits are designed to provide reasonable protection against harmful interference when the equipment is operated in a commercial environment. This equipment generates, uses, and can radiate radio frequency energy and, if not installed and used in accordance with the instruction manual, may cause harmful interference to radio communications. Operation of this equipment in a residential area is likely to cause harmful interference in which case the user will be required to correct the interference at his own expense.

9.1.3. Part 15.21

Any changes or modifications to this equipment not expressly approved by Northern Mechatronics may cause harmful interference and void the user's authority to operate this equipment.

9.2. ISED Compliance Statement

This device complies with FCC and Industry Canada RF radiation exposure limits set forth for general population for mobile application (uncontrolled exposure). This device must not be collocated or operating in conjunction with any other antenna or transmitter.

9.2.1. Compliance Statement

Notice: This device complies with Industry Canada license-exempt RSS standard(s). Operation is subject to the following two conditions: (1) this device may not cause interference, and (2) this device must accept any interference, including interference that may cause undesired operation of the device.

Industry Canada ICES-003 Compliance Label: CAN ICES-3 (A)/NMB-3(A)

9.2.2. Déclaration de conformité

Avis: Le présent appareil est conforme aux CNR d'Industrie Canada applicables aux appareils radio exempts de licence. L'exploitation est autorisée aux deux conditions suivantes: (1) l'appareil ne doit pas produire de brouillage, et (2) l'utilisateur de l'appareil doit accepter tout brouillage radioélectrique subi, même si le brouillage est susceptible d'en compromettre le fonctionnement.

Étiquette de conformité à la NMB-003 d'Industrie Canada: CAN ICES-3 (A)/NMB-3(A)

10.Document Details

Parameter	Value
Name	NM180100 EVB User Guide
Number	2000008
Revision	A.3
Life Cycle State	In Work