

SY-906

TYPICAL S.W.R. RESPONSE

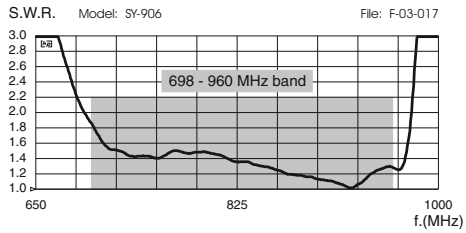

TYPICAL RADIATION PATTERN at 880 MHz

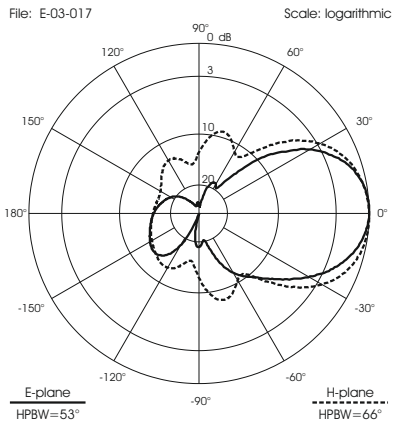

TYPICAL GAIN DIAGRAM vs FREQUENCY

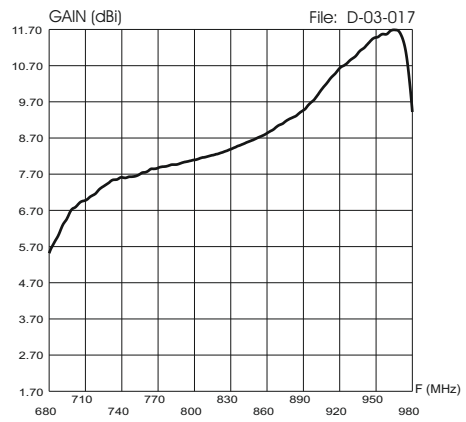

SY-910

TYPICAL S.W.R. RESPONSE

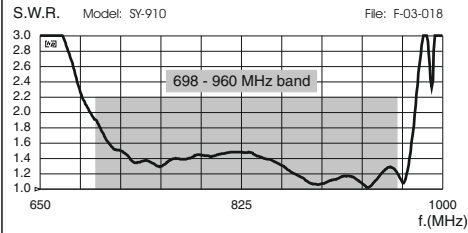

TYPICAL RADIATION PATTERN at 880 MHz

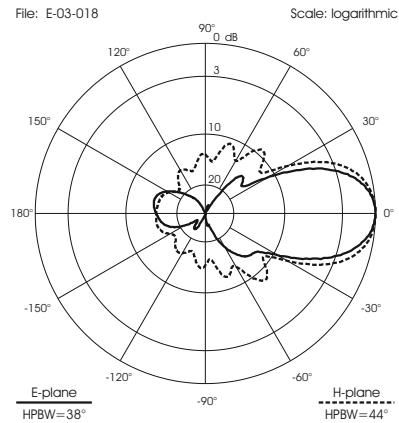

TYPICAL GAIN DIAGRAM vs FREQUENCY

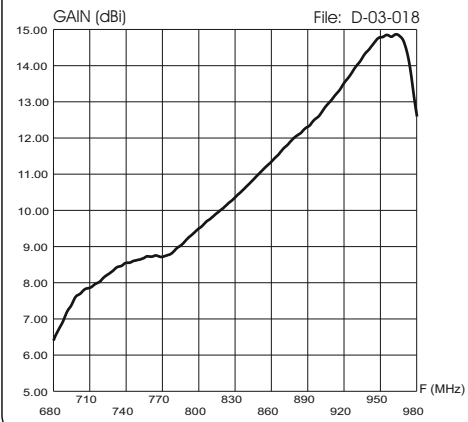

SY-906 SY-910 Base Station Yagi Antennas 698-960 MHz

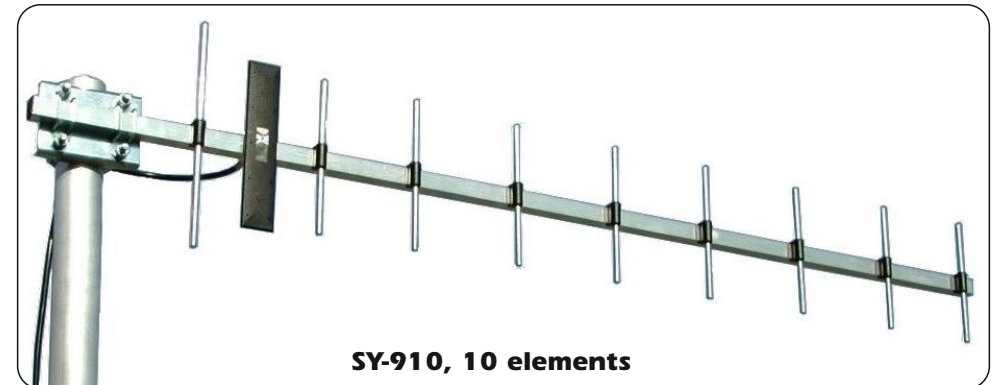

DESCRIPTION

Base station antennas conceived for LTE 700, ISM 868 MHz, AMPS, GSM 900 systems working on 698-960 MHz. The boom and the parasitic elements are made of aluminium and radiant dipole is realized on PCB in Microstrip technology protected by thermoplastic.

SPECIFICATIONS

Electrical Data	SY 906	SY 910
Type	6 elements yagi antenna	10 elements yagi antenna
Frequency Range	698 - 960 MHz (LTE 700, ISM, AMPS, GSM 900)	
Impedance	50 Ω	
Radiation (H-plane) Beamwidth @ -3 dB	66° @ 880 MHz	44° @ 880 MHz
Radiation (E-plane) Beamwidth @ -3 dB	53° @ 880 MHz	38° @ 880 MHz
Radiation angle deg.	0°	
Front to back ratio	≥ 12 dB @ 698 - 880 MHz ≥ 15 dB @ 880 - 960 MHz	≥ 13 dB @ 698 - 880 MHz ≥ 15 dB @ 880 - 960 MHz
Polarization	Linear Vertical	
Max Gain	11.5 dBi	15 dBi
Cross Polarization Isolation	≥ 18 dB	≥ 20 dB
Max Power (CW) @ 30° C	10 Watts	
Grounding Protection	All metal parts are DC-grounded, the inner conductor shows a DC-short	
Connector	FME-male	

Mechanical Data

Housing & Radome Material	Aluminium, PCB, Thermoplastic	
Bracket & Hardware Material	Galvanized Steel	
Wind Load	27 N @ 150 Km/h	48 N @ 150 Km/h
Wind Resistance	180 Km/h	150 Km/h
Wind Surface	0.02 m ²	0.03 m ²
Dimensions (approx.)	210 x 595 x 60 mm	210 x 995 x 60 mm
Turning radius (approx.)	580 mm	960 mm
Weight (approx.)	410 gr	500 gr
Operating Temperature	-20 °C to +80 °C	
Installation type	Mast: \varnothing 25-42 mm with U-bolt	

MOUNTING INSTRUCTIONS

