	Date	6-Feb-2020	<b>SPECIFICATION</b>	OLE WOLFF
	Page	1 / 8		www.owolff.com
	DK	P/N: OWS-4021TA-4		Revision: 00



# SPECIFICATION FOR APPROVAL

## Speaker

Part Number	OWS-4021TA-4
Note	This item was compliance with the following requirements: 1. RoHS directive 2. REACH
Customer P/N	

Ole Wolff	Signature / Date	Prepared	Checked	Approved
		YanRui 2020.2.6		

Customer	Signature / Date	Confirmation		

### REVISION NOTES:

Date	Rev.	Description of Revision
2020.2.6	00	Initial Release

OLE WOLFF ELEKTRONIK A/S Roedengvej 25 4180 Soroe Denmark  TEL: +45 57833830 FAX: +45 57820019	OLE WOLFF ELECTRONICS INC. 1525 McCarthy Blvd, Suite 1093 Milpitas, Ca 95035 USA  TEL: +1 408 888 8413	OLEWOLFF ELEKTRONIK GmbH Schulstrasse 15A. DE-25451 Quickborn. Germany  TEL: +49 (0) 4106 765900 FAX: +49 (0) 4106 627297	OLEWOLFF ELECTRONICS 3 Bedford Street, Woburn, Bedfordshire MK17 9QB, ENGLAND  TEL: +44 (0) 1525 290755 FAX: +44 (0) 1525 290855	OLE WOLFF ELEKTRONIK Yhöpistonkatu 26 (P.O.BOX 257) FI-40101 Jyväskylä Finland  TEL: +358 14 338 3050 FAX: +358 14 338 3059	OLE WOLFF (ASIA) LTD. Unit B, 19/F, Bold Win Ind. Bldg., No. 16-18 Wah Sing St., Kwai Chung, N.T., H.K.  TEL: +852 2424 3274 FAX: +852 2424 2219	OLE WOLFF LTD. 5 Floor, Block G, WenTao Industrial Park, YingRenShi, Bao'an District, Shenzhen, PRC  TEL: +86 755 82612542 TEL: +86 755 26406156
---	---	--	---	---	---	---

	Date	6-Feb-2020	<b>SPECIFICATION</b>	OLE WOLFF
	Page	2 / 8		www.owolff.com
	DK	P/N: OWS-4021TA-4		Revision: 00

## 1. SCOPE

THIS SPECIFICATION IS APPLIED FOR A DYNAMIC SPEAKER.

## 2. TEST CONDITIONS

TEMPERATURE : 15 °C ~ 35 °C

HUMIDITY : 45%~85% (R.H.)

ATMOSPHERE : 860 ~ 1060 hPa

## 3. GENERAL REQUIREMENTS

OPERATING TEMPERATURE RANGE: -20 °C ~ 60 °C

STORAGE TEMPERATURE RANGE: -20 °C ~ 60 °C

## 4. MECHANICAL LAYOUT & DIMENSIONS

DIMENSIONS : SHOWN IN FIGURE.4

NET WEIGHT: approx 28g

## 5. ELECTRICAL AND ACOUSTICAL CHARACTERISTICS

1	IMPEDANCE	$4 \pm 15\% \Omega$
2	SOUND PRESSURE LEVEL	$85 \pm 3\text{dB}$ 1W/0.5m at (AVG 0.8,1.0,1.6,2.0)KHz baffleboard (IEC), MEASUREMENT AS SHOWN IN FIGURE.1
3	FREQUENCY RESPONSE CURVE	SHOW IN FIGURE 2
4	RESONANCE FREQUENCY	$180 \pm 20\%$ Hz in free air at 1.0Vrms
5	TOTAL HARMONIC DISTORTION (THD)	SHOW IN FIGURE 3 < 5% at 1KHz
6	BUZZ & RATTLE	DYNAMIC SPEAKER MUST BE FREE AUDIBLE NOISE AT 3.46Vrms, SINE WAVE BETWEEN 20Hz AND 2KHz FREQUENCY RANGE.
7	INPUT POWER	(Nom./Max.): 3 W / 5W

OLE WOLFF ELEKTRONIK A/S Roedengvej 25 4180 Soroe Denmark  TEL: +45 57833830 FAX: +45 57820019	OLE WOLFF ELECTRONICS INC. 1525 McCarthy Blvd, Suite 1093 Milpitas, Ca 95035 USA  TEL: +1 408 888 8413	OLEWOLFF ELEKTRONIK GmbH Schulstrasse 15A. DE-25451 Quickborn. Germany  TEL: +49 (0) 4106 765900 FAX: +49 (0) 4106 627297	OLEWOLFF ELECTRONICS 3 Bedford Street, Woburn, Bedfordshire MK17 9QB, ENGLAND  TEL: +44 (0) 1525 290755 FAX: +44 (0) 1525 290855	OLE WOLFF ELEKTRONIK Yhöpistonkatu 26 (P.O.BOX 257) FI-40101 Jyväskylä Finland  TEL: +358 14 338 3050 FAX: +358 14 338 3059	OLE WOLFF (ASIA) LTD. Unit B, 19/F, Bold Win Ind. Bldg., No. 16-18 Wah Sing St., Kwai Chung, N.T., H.K.  TEL: +852 2424 3274 FAX: +852 2424 2219	OLE WOLFF LTD. 5 Floor, Block G, WenTao Industrial Park, YingRenShi, Bao'an District, Shenzhen, PRC  TEL: +86 755 82612542 TEL: +86 755 26406156
---	---	--	---	---	---	---

	Date	6-Feb-2020	<b>SPECIFICATION</b>	OLE WOLFF
	Page	3 / 8		www.owolff.com
	DK	P/N: OWS-4021TA-4		Revision: 00

## 6. RELIABILITY TEST REQUIREMENTS.

After any following tests the S.P.L should not deviate more than  $\pm 3\text{dB}$  from initial value.

No.	ITEMS	TEST CONDITION
1.	High temp. Test	Temperature: $+60\text{ }^{\circ}\text{C} \pm 3^{\circ}\text{C}$ Duration: 96 hours
2.	Low temp. Test	Temperature: $-20\text{ }^{\circ}\text{C} \pm 3^{\circ}\text{C}$ Duration: 96 hours
3.	Humidity Test	Temperature: $+40\text{ }^{\circ}\text{C} \pm 3^{\circ}\text{C}$ Relative Humidity: 90-95% RH Duration: 96 hours (recovery 6 hours)
4.	Thermal cycle test.	Low temperature: $-25^{\circ}\text{C} \pm 2^{\circ}\text{C}$ , temperature: $+60^{\circ}\text{C} \pm 2^{\circ}\text{C}$ , cycle: 1 hour/cycle each, and then keep 4 cycles in a room.
5.	Vibration Test	Frequency: 10 ~ 55 ~ 10Hz Oct/min Amplitude: 1.5mm Duration: 2hours in each 3axes
6.	Drop Test	Free drop from 60cm height to a board of 20mm thick one point ,three corners ,six sides. 1 times each, total 10 times.
7.	Load test	Input power: 3W, Pink noise 96hours .
8.	Terminal Strength	Load: 1.0 Kg Duration: 15sec.(Shall be normal)

OLE WOLFF ELEKTRONIK A/S Roedengvej 25 4180 Soroe Denmark  TEL: +45 57833830 FAX: +45 57820019	OLE WOLFF ELECTRONICS INC. 1525 McCarthy Blvd, Suite 1093 Milpitas, Ca 95035 USA  TEL: +1 408 888 8413	OLEWOLFF ELEKTRONIK GmbH Schulstrasse 15A. DE-25451 Quickborn. Germany  TEL: +49 (0) 4106 765900 FAX: +49 (0) 4106 627297	OLEWOLFF ELECTRONICS 3 Bedford Street, Woburn, Bedfordshire MK17 9QB, ENGLAND  TEL: +44 (0) 1525 290755 FAX: +44 (0) 1525 290855	OLE WOLFF ELEKTRONIK Yhöpistonkatu 26 (P.O.BOX 257) FI-40101 Jyväskylä Finland  TEL: +358 14 338 3050 FAX: +358 14 338 3059	OLE WOLFF (ASIA) LTD. Unit B, 19/F, Bold Win Ind. Bldg., No. 16-18 Wah Sing St., Kwai Chung, N.T., H.K.  TEL: +852 2424 3274 FAX: +852 2424 2219	OLE WOLFF LTD. 5 Floor, Block G, WenTao Industrial Park, YingRenShi, Bao'an District, Shenzhen, PRC  TEL: +86 755 82612542 TEL: +86 755 26406156
---	---	--	---	---	---	---

	Date	6-Feb-2020	<b>SPECIFICATION</b>	OLE WOLFF
	Page	4 / 8		www.owolff.com
	DK	P/N: OWS-4021TA-4		Revision: 00

## 7. ELECTRICAL CHARACTERISTICS MEASUREMENT (FIGURE.1)

### MEASUREMENT CIRCUIT FOR DYNAMIC SPEAKER

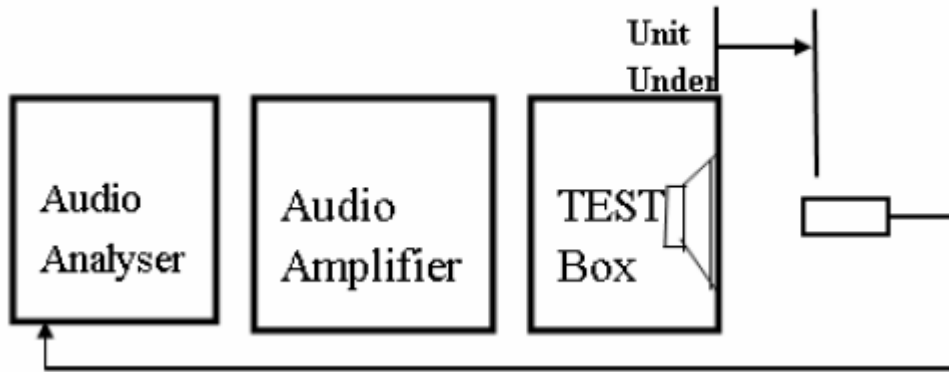

### MEASURING EQUIPMENT

NO	EQUIPMENT	REMARKS
1.0	UNIT UNDER TEST	SPEAKER
2.0	TEST BOX	OLE WOLFF STANDARD BOX
3.0	AUDIO POWER AMPLIFIER	CRATE AUDIO SPA300
4.0	ANALYZER	LISTEN SOUNDCHECK

OLE WOLFF ELEKTRONIK A/S Roedengvej 25 4180 Soroe Denmark  TEL: +45 57833830 FAX: +45 57820019	OLE WOLFF ELECTRONICS INC. 1525 McCarthy Blvd, Suite 1093 Milpitas, Ca 95035 USA  TEL: +1 408 888 8413	OLEWOLFF ELEKTRONIK GmbH Schulstrasse 15A. DE-25451 Quickborn. Germany  TEL: +49 (0) 4106 765900 FAX: +49 (0) 4106 627297	OLEWOLFF ELECTRONICS 3 Bedford Street, Woburn, Bedfordshire MK17 9QB, ENGLAND  TEL: +44 (0) 1525 290755 FAX: +44 (0) 1525 290855	OLE WOLFF ELEKTRONIK Yhöpistonkatu 26 (P.O.BOX 257) FI-40101 Jyväskylä Finland  TEL: +358 14 338 3050 FAX: +358 14 338 3059	OLE WOLFF (ASIA) LTD. Unit B, 19/F, Bold Win Ind. Bldg., No. 16-18 Wah Sing St., Kwai Chung, N.T., H.K.  TEL: +852 2424 3274 FAX: +852 2424 2219	OLE WOLFF LTD. 5 Floor, Block G, WenTao Industrial Park, YingRenShi, Bao'an District, Shenzhen, PRC  TEL: +86 755 82612542 TEL: +86 755 26406156
---	---	--	---	---	---	---

	Date	6-Feb-2020	<b>SPECIFICATION</b>	OLE WOLFF
	Page	5 / 8		www.owolff.com
	DK	P/N: OWS-4021TA-4	Revision: 00	

## 8. STANDARD FREQUENCY RESPONSE CURVE(FIGURE.2)

3.46Vrms /0.5m

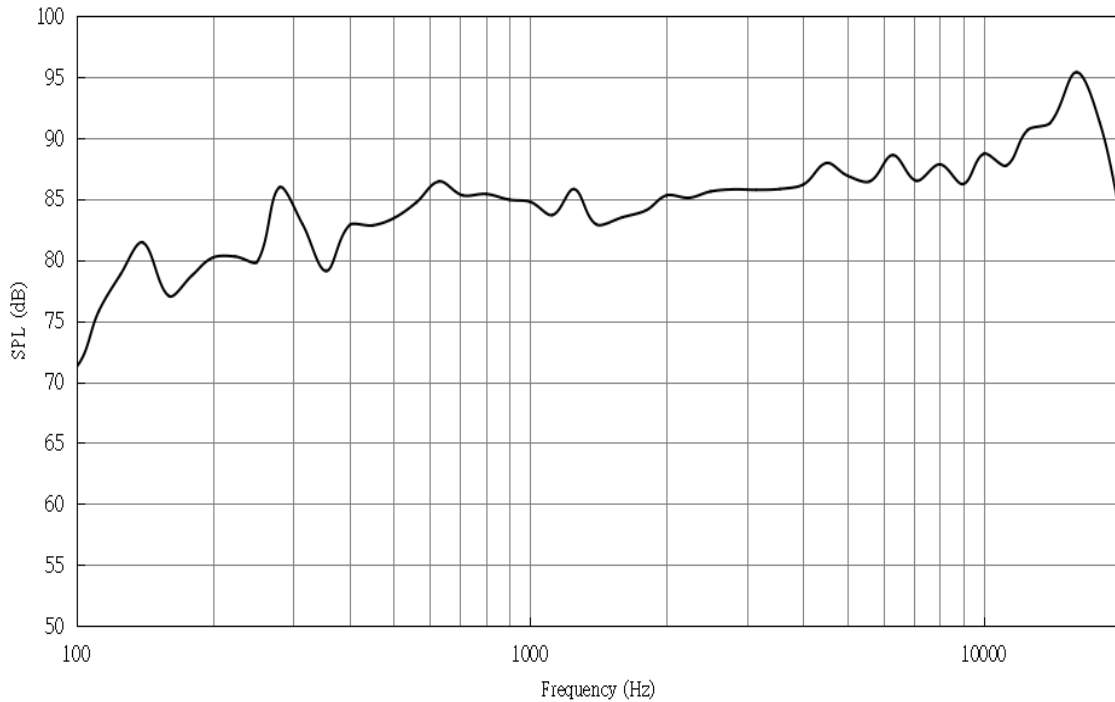

## 9. STANDARD THD CURVE (FIGURE.3)

3.46Vrms /0.5m

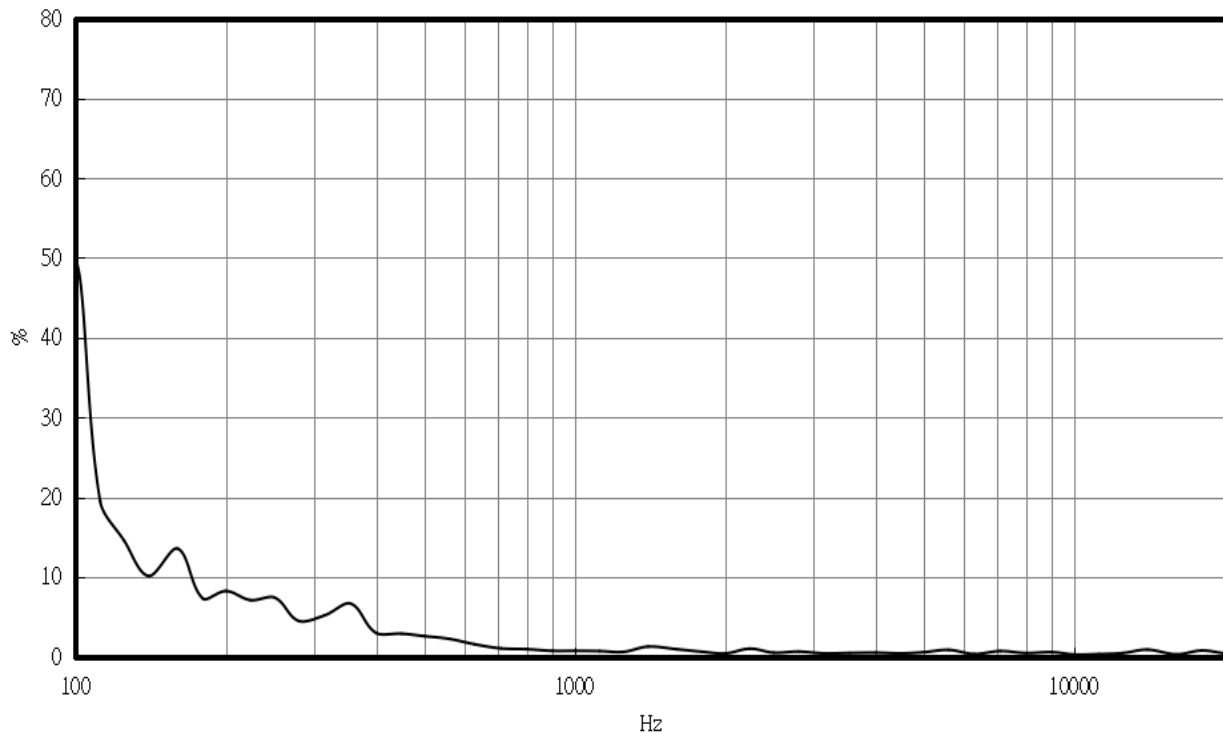

OLE WOLFF ELEKTRONIK A/S Roedengvej 25 4180 Soroe Denmark TEL: +45 57833830 FAX: +45 57820019	OLE WOLFF ELECTRONICS INC. 1525 McCarthy Blvd, Suite 1093 Milpitas, Ca 95035 USA TEL: +1 408 888 8413	OLEWOLFF ELEKTRONIK GmbH Schulstrasse 15A. DE-25451 Quickborn. Germany TEL: +49 (0) 4106 765900 FAX: +49 (0) 4106 627297	OLEWOLFF ELECTRONICS 3 Bedford Street, Woburn, Bedfordshire MK17 9QB, ENGLAND TEL: +44 (0) 1525 290755 FAX: +44 (0) 1525 290855	OLE WOLFF ELEKTRONIK Yhopistonkatu 26 (P.O.BOX 257) FI-40101 Jyväskylä Finland TEL: +358 14 338 3050 FAX: +358 14 338 3059	OLE WOLFF (ASIA) LTD. Unit B, 19/F, Bold Win Ind. Bldg., No. 16-18 Wah Sing St., Kwai Chung, N.T., H.K. TEL: +852 2424 3274 FAX: +852 2424 2219	OLE WOLFF LTD. 5 Floor, Block G, WenTao Industrial Park, YingRenShi, Bao'an District, Shenzhen, PRC TEL: +86 755 82612542 TEL: +86 755 26406156
---	---	--	---	---	---	---

	Date	6-Feb-2020	<b>SPECIFICATION</b>	OLE WOLFF
	Page	6 / 8		www.owolff.com
	DK	P/N: OWS-4021TA-4		Revision: 00

## 10. OUTVIEW (FIGURE.4)

Unless otherwise specified, tolerance:  $\pm 0.5$  (unit: mm)

## 11.

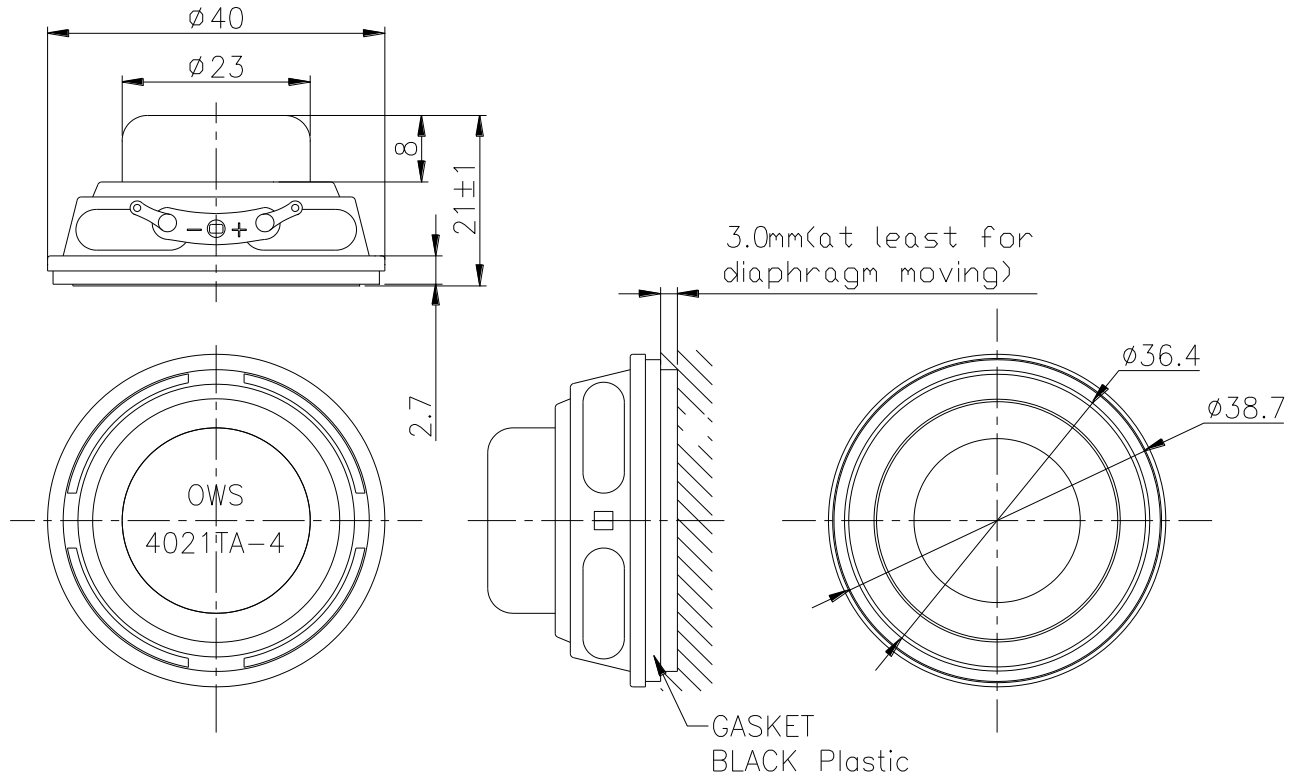

OLE WOLFF ELEKTRONIK A/S Roedengvej 25 4180 Soroe Denmark TEL: +45 57833830 FAX: +45 57820019	OLE WOLFF ELECTRONICS INC. 1525 McCarthy Blvd, Suite 1093 Milpitas, Ca 95035 USA TEL: +1 408 888 8413	OLEWOLFF ELEKTRONIK GmbH Schulstrasse 15A. DE-25451 Quickborn. Germany TEL: +49 (0) 4106 765900 FAX: +49 (0) 4106 627297	OLEWOLFF ELECTRONICS 3 Bedford Street, Woburn, Bedfordshire MK17 9QB, ENGLAND TEL: +44 (0) 1525 290755 FAX: +44 (0) 1525 290855	OLE WOLFF ELEKTRONIK Yhdistonkatu 26 (P.O.BOX 257) FI-40101 Jyväskylä Finland TEL: +358 14 338 3050 FAX: +358 14 338 3059	OLE WOLFF (ASIA) LTD. Unit B, 19/F., Bold Win Ind. Bldg., No. 16-18 Wah Sing St., Kwai Chung, N.T., H.K. TEL: +852 2424 3274 FAX: +852 2424 2219	OLE WOLFF LTD. 5 Floor, Block G, WenTao Industrial Park, YingRenShi, Bao'an District, Shenzhen, PRC TEL: +86 755 82612542 TEL: +86 755 26406156
---	---	--	---	--	--	---

	Date	6-Feb-2020	<b>SPECIFICATION</b>	OLE WOLFF
	Page	7 / 8		www.owolff.com
	DK	P/N: OWS-4021TA-4		Revision: 00

**MARKING(FIGURE.5)**

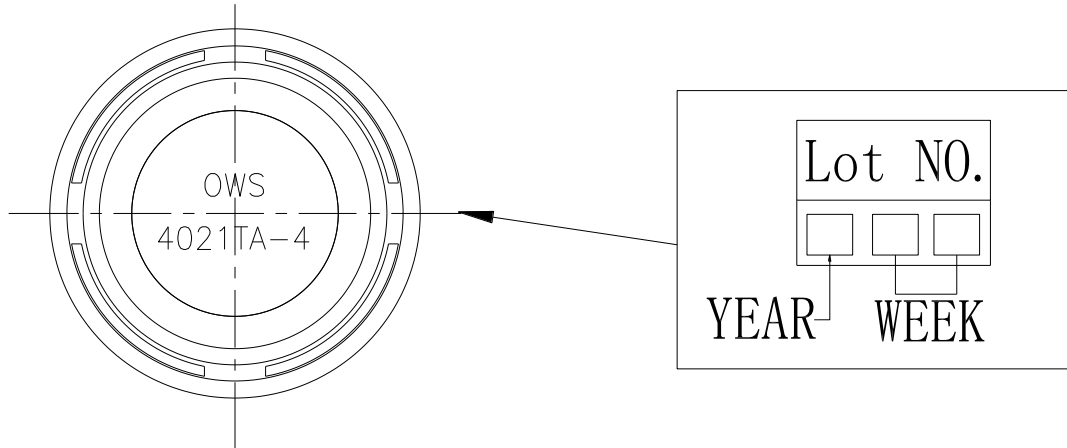

YEAR		WEEK	
year	marking	week	marking
2015	5	6	06
2016	6	↓	↓
2017	7		
2018	8		
		50	50
		51	51
		52	52
		53	53

↑

OLE WOLFF ELEKTRONIK A/S Roedengvej 25 4180 Soroe Denmark  TEL: +45 57833830 FAX: +45 57820019	OLE WOLFF ELECTRONICS INC. 1525 McCarthy Blvd, Suite 1093 Milpitas, Ca 95035 USA  TEL: +1 408 888 8413	OLEWOLFF ELEKTRONIK GmbH Schulstrasse 15A. DE-25451 Quickborn. Germany  TEL: +49 (0) 4106 765900 FAX: +49 (0) 4106 627297	OLEWOLFF ELECTRONICS 3 Bedford Street, Woburn, Bedfordshire MK17 9QB, ENGLAND  TEL: +44 (0) 1525 290755 FAX: +44 (0) 1525 290855	OLE WOLFF ELEKTRONIK Yhöpistonkatu 26 (P.O.BOX 257) FI-40101 Jyväskylä Finland  TEL: +358 14 338 3050 FAX: +358 14 338 3059	OLE WOLFF (ASIA) LTD. Unit B, 19/F, Bold Win Ind. Bldg., No. 16-18 Wah Sing St., Kwai Chung, N.T., H.K.  TEL: +852 2424 3274 FAX: +852 2424 2219	OLE WOLFF LTD. 5 Floor, Block G, WenTao Industrial Park, YingRenShi, Bao'an District, Shenzhen, PRC  TEL: +86 755 82612542 TEL: +86 755 26406156
---	---	--	---	---	---	---

	Date	6-Feb-2020	<b>SPECIFICATION</b>	OLE WOLFF
	Page	8 / 8		www.owolff.com
	DK	P/N: OWS-4021TA-4		Revision: 00

## 12. PACKING(Figure.6)

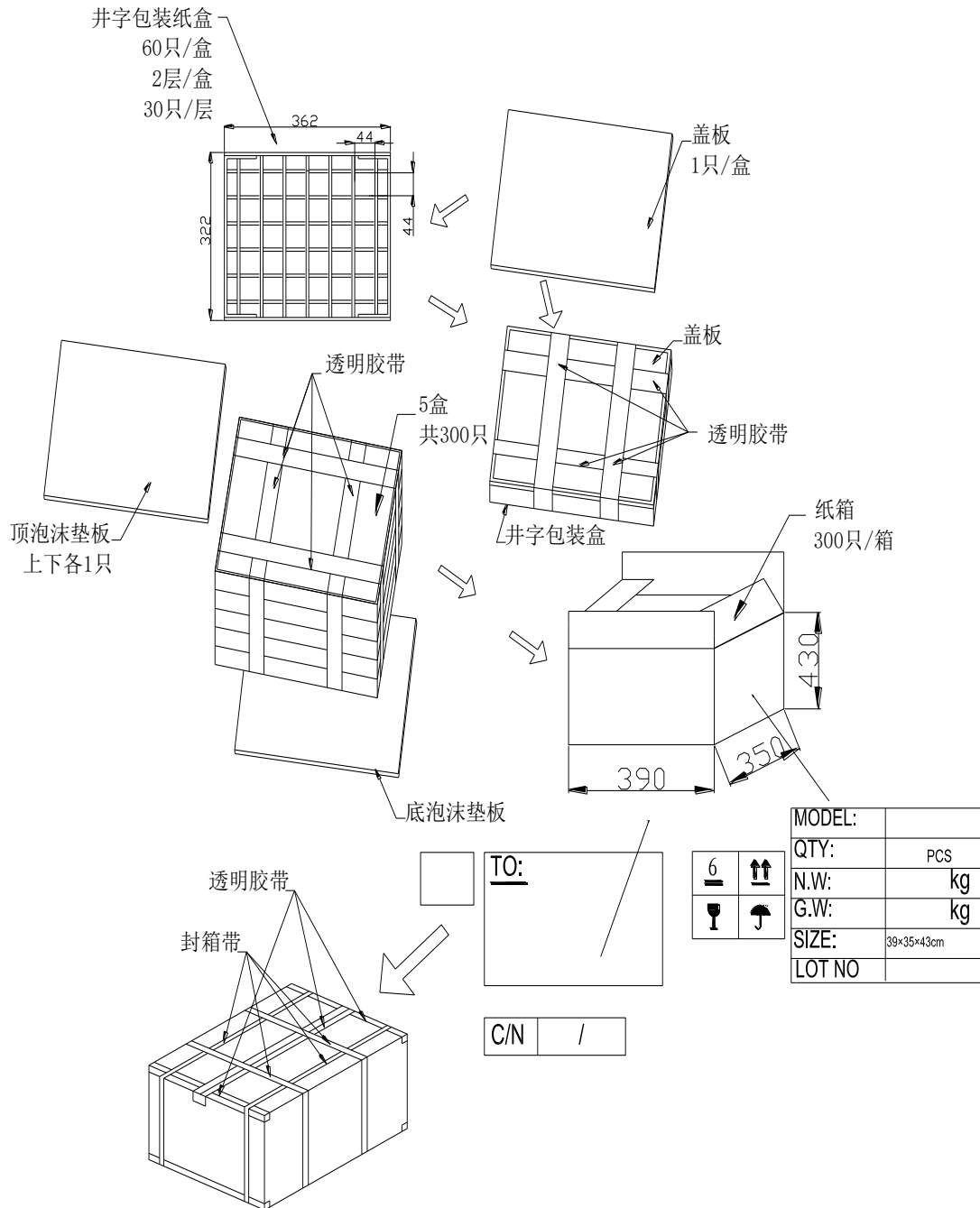

OLE WOLFF ELEKTRONIK A/S Roedengvej 25 4180 Soroe Denmark TEL: +45 57833830 FAX: +45 57820019	OLE WOLFF ELECTRONICS INC. 1525 McCarthy Blvd, Suite 1093 Milpitas, Ca 95035 USA TEL: +1 408 888 8413	OLEWOLFF ELEKTRONIK GmbH Schulstrasse 15A. DE-25451 Quickborn. Germany TEL: +49 (0) 4106 765900 FAX: +49 (0) 4106 627297	OLEWOLFF ELECTRONICS 3 Bedford Street, Woburn, Bedfordshire MK17 9QB, ENGLAND TEL: +44 (0) 1525 290755 FAX: +44 (0) 1525 290855	OLE WOLFF ELEKTRONIK Yhöpistonkatu 26 (P.O.BOX 257) FI-40101 Jyväskylä Finland TEL: +358 14 338 3050 FAX: +358 14 338 3059	OLE WOLFF (ASIA) LTD. Unit B, 19/F, Bold Win Ind. Bldg., No. 16-18 Wah Sing St., Kwai Chung, N.T., H.K. TEL: +852 2424 3274 FAX: +852 2424 2219	OLE WOLFF LTD. 5 Floor, Block G, WenTao Industrial Park, YingRenShi, Bao'an District, Shenzhen, PRC TEL: +86 755 82612542 TEL: +86 755 26406156
---	---	--	---	---	---	---