

PART NUMBER **BL23E33-02-HP50**

MOTOR SPECIFICATIONS

Part Number	BL23E33-02
Dimension "A"	3.29 in 83.5 mm
Rated Voltage	48 VDC
Rated Torque	41.07 oz-in 0.29 N-m
Rated Speed	4000 RPM
Rated Power	120 Watts
Rated Current	3 Amps
Peak Torque	82.13 oz-in 0.58 N-m
Peak Current	6 Amps
Torque Constant (kt)	13.74 oz-in/Amp
Back EMF Constant (Ke)	9.02 Vp/KRPM
Motor Constant (Km)	15.76 oz-in/√W 0.111 N-m/√W
Resistance	0.76 Ohms
Inductance	84 mH
Rotor Inertia	0.153 oz-in ²
Weight	2.38 lb 1.08 kg
Electrical Time Constant	1.1 ms
Mechanical Time Constant	2.5 ms

GEARBOX SPECIFICATIONS

Part Number	HP50
Ratio	50:1
Nominal Output Torque (Nm)	60
Emergency Stop Torque (Nm)	3 times nominal output torque
Nominal Input Speed (RPM)	5000
Max Input Speed (RPM)	10000
Max Radial Load (N)	1377
Max Axial Load (N)	765
Efficiency η (%)	85
Backlash (arcmin)	<7
Protection Class	IP65 (gearbox), IP40 (motor)
Service Life (hr)	20000
Weight (kg)	1.6
Operating Temperature (°C)	-20 to 90
Lubrication	Grease
Noise (n=3000 rpm) dB(A)	55
Mass Movement of Inertia (kg-cm ²)	0.03



PERFORMANCE CURVE

BL23E33-02 GEARMOTOR TORQUE CURVES

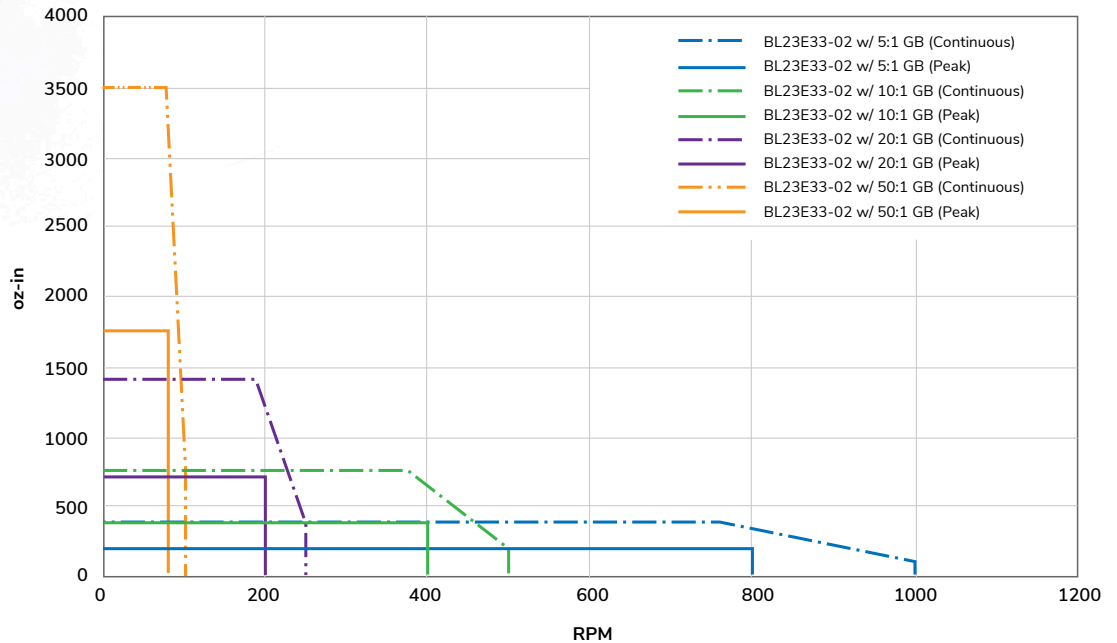

DIMENSIONS

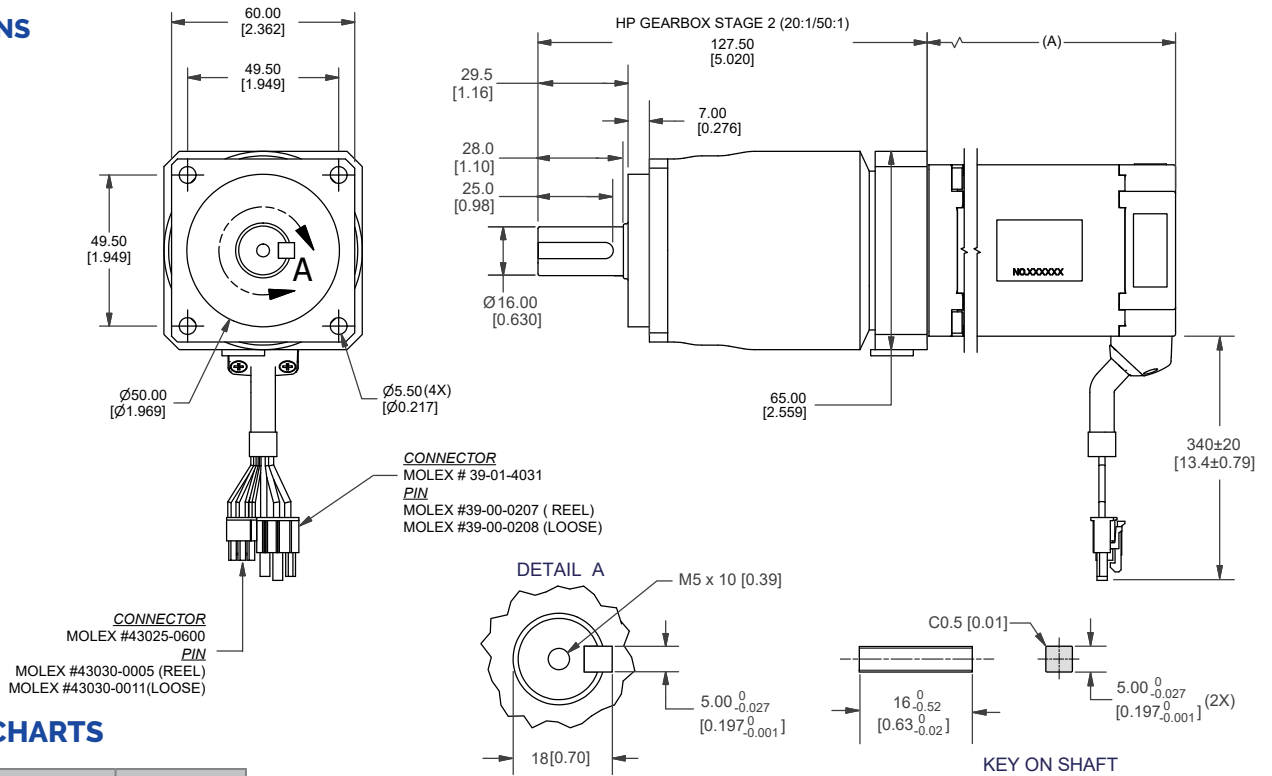

PIN OUT CHARTS

PIN #	COLOR	PHASE
1	RED	VCC (+5V)
2	YELLOW	HV
3	BLUE	HW
4	BLACK	GND
5	ORANGE	HU

PIN #	COLOR	PHASE
1	BLUE	W
2	ORANGE	U
5	YELLOW	V

RECOMMENDED PRODUCTS



BLDC DRIVER
BLDC50-BL23E22-02



BLDC EXTENSION CABLE
4201-100/300

OPERATION & USAGE TIPS

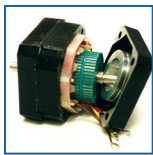

Do not disassemble motors; a significant reduction in motor performance will occur.

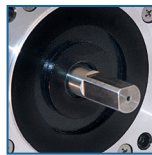

Do not machine shafts; this will have a negative effect on shaft run out and perpendicularity.

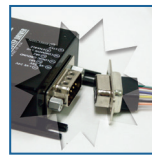

Do not disconnect motor from drive while in operation.

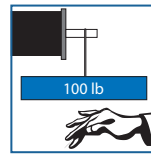

Do not use holding torque/detent torque of motor as a fail safe brake.

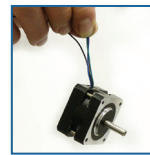

Do not hold motor by lead wires.



Do not exceed the rated current; this will damage the motor.

FAILURE TO COMPLY WITH THESE RECOMMENDATIONS WILL VOID ALL WARRANTY TERMS

Motion Control, Solved.

MOTOR ENGINEERING & MANUFACTURING



Optimized
For Your
Application



Quick
Prototype
Turnaround



Small Batch
to OEM Volume
Production



US Based
Support &
Manufacturing