

OCS-260

180...220W DC/AC SINE WAVE INVERTER

GENERAL FEATURES:

- Sine wave output voltage
- Selectable output frequency: 50/60Hz
- Adjustable output voltage
- Output failure alarm
- Remote inhibit
- High input-output isolation 3000Vrms
- Optional railway version EN50155
- Fire and smoke: EN45545-2 approved



	12Vdc 9.5 ... 15V ⁽¹⁾	24Vdc 16.8 ... 30V	36Vdc 25.2 ... 45V	48Vdc 33.6 ... 60V	72Vdc 50.4 ... 90V	110Vdc 77 ... 138V
120Vac	OCS-260-7041 180W	OCS-260-7043 200W	OCS-260-7044 220W	OCS-260-7045 220W	OCS-260-7046 220W	OCS-260-7047 220W
230Vac	OCS-260-7031 180W	OCS-260-7033 200W	OCS-260-7034 220W	OCS-260-7035 220W	OCS-260-7036 220W	OCS-260-7037 220W

Note ⁽¹⁾: Startup voltage ≤10.2V. Under-voltage shutdown ≤ 9.1V



INPUT	
Input voltage range	See table
Maximum input ripple	5% Vin nom (Vrms, 100Hz)
OUTPUT	
Nominal output voltage (Vonom)	See table
Adjust range	± 5% of Vonom
Load regulation	4%
Line regulation	0.4% @ ΔVin -20...+25% 10% @ ΔVin -30...+25% 1% @ ΔVin -10...+25% for 12V input models 10% @ ΔVin -20...+25% for 12V input models
Output frequency	50 / 60Hz ± 0.25Hz
Output wave distortion THD	< 2% (16 samples average)
Output voltage HF ripple	< 20Vpp for 230Vac models < 10Vpp for 120Vac models
ENVIRONMENTAL	
Storage temperature	-40 ... 80°C
Operating temperature (full load)	-40 ... 55°C
Operating temperature (62.5% load)	-40 ... 70°C
Cooling	Natural convection
MTBF (MIL-HDBK-217-E; G _b , 25°C)	250.000 h
EMC	
Immunity according	EN61000-6-2 EN50121-3-2
Emissions according	EN61000-6-4 EN50121-3-2
SAFETY	
Safety according to	EN60950-1, EN62368-1 Class I OV category II, Pollution degree 2 Input / output isolation: reinforced
Dielectric strength: Input /output	3000 Vrms / 50Hz / 1min (routine test 2s)
Dielectric strength: Output / ground	1500 Vrms / 50Hz / 1min (routine test 2s)
Dielectric strength: Input / ground	500 Vrms / 50Hz / 1min (routine test 2s)
Fire and smoke	EN45545-2
MECHANICAL	
Weight	900 g
Dimensions	100 x 220 x 40mm
PROTECTIONS	
Against input over-currents	Internal fuse
Against output overloads < Iompk	linear
Against output overloads > Iompk	Triggered
CONTROL	
Remote inhibit input	4 ... 24 Vdc
Output failure alarm	Solid state relay, open when alarm. Max: 60V, 0.3A

ORDERING CODES

Model	Input Voltage DC [V]	Input voltage range [V]	Max. Input Current [A]	Output voltage AC [V]	Output current [A]	Active output power [W]	Appar. output power [VA]	Output Peak curr. 10ms [A]	Efficiency [%] *	No load input current [A] *
OCS-260-7031	12	9.50 - 15	22.1	230	0.78	180	260	4.0	86	0.65
OCS-260-7033	24	16.8 - 30	13.7	230	0.87	200	260	4.0	87	0.37
OCS-260-7034	36	25.0 - 45	10.0	230	0.96	220	260	4.0	88	0.21
OCS-260-7035	48	33.6 - 60	7.36	230	0.96	220	260	4.0	89	0.17
OCS-260-7036	72	50.4 - 90	4.91	230	0.96	220	260	4.0	89	0.12
OCS-260-7037	110	77 - 138	3.17	230	0.96	220	260	4.0	90	0.08
OCS-260-7041	12	9.50 - 15	22.3	120	1.50	180	260	7.6	85	0.65
OCS-260-7043	24	16,8 - 30	13.7	120	1.67	200	260	7.6	87	0.35
OCS-260-7044	36	25.0 - 45	10.0	120	1,83	220	260	7.6	88	0.21
OCS-260-7045	48	33.6 - 60	7.45	120	1,83	220	260	7.6	88	0.15
OCS-260-7046	72	50.4 - 90	4.97	120	1,83	220	260	7.6	88	0.12
OCS-260-7047	110	77 - 138	3.22	120	1,83	220	260	7.6	89	0.08

* Typical values

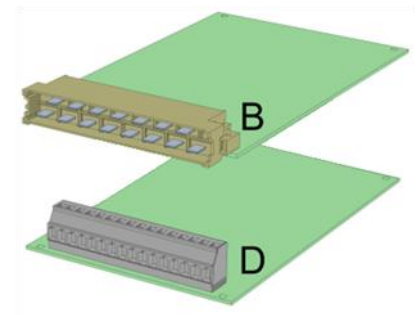
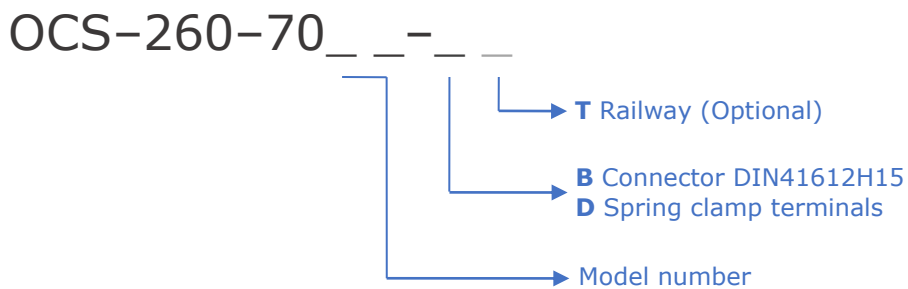

Accessories must be ordered in a separated order line

BLOCKS DIAGRAM

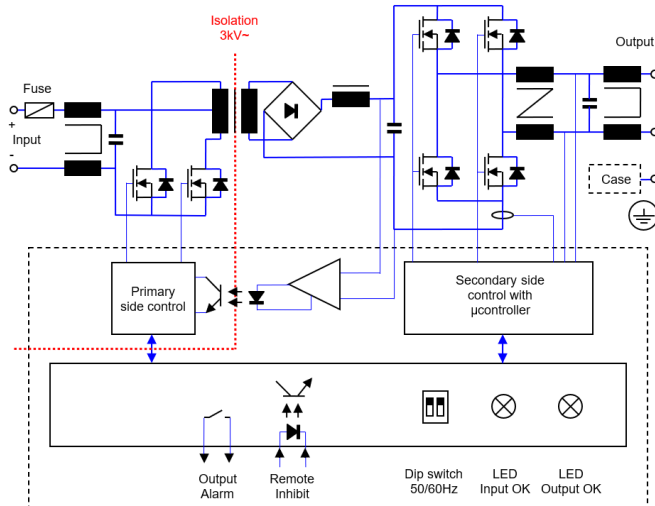

CONNECTIONS

Connector DIN41612H15 (Max. 12A / terminal)

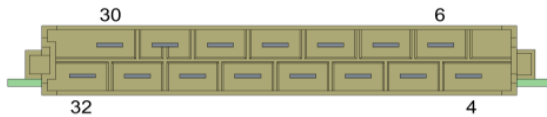

Spring clamp terminals (Max. 12A / terminal)

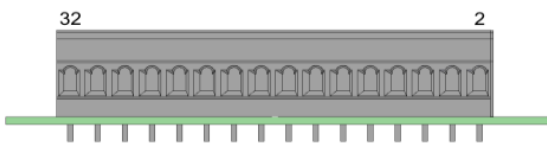

CONNECTION	Terminal
-Vin	2, 4, 6
+Vin	8, 10
-Inhibit	12
+Inhibit	14
-Alarm	16
+Alarm	18
N	22, 24
L	28, 30
PE	32

POWER DERATING vs AMBIENT TEMP.



DESCRIPTION

The OCS-260 consists of sine-wave 120Vac or 230Vac output voltage DC-AC converters. The frequency can be set to 50Hz or 60 Hz, and input and output are galvanically isolated.

The OCS-260 inverters consist of two cascaded converters, one DC-DC generating an intermediate output voltage from the input voltage. That intermediate voltage is inverted to supply the output voltage and frequency by means of a second DC/AC converter.

The input is protected against reverse polarity by means of fuse and against under-voltage by unit shutdown.

The output has protection of maximum average power and maximum peak current. The unit shutdowns when the operation curve limit is exceeded for more than one second. Every 2 seconds after shutdown, the unit tries to restart up to 3 times. If the overload persists, the unit remains shutdown until an input reconnection.

OPERATION CURVE LIMITS

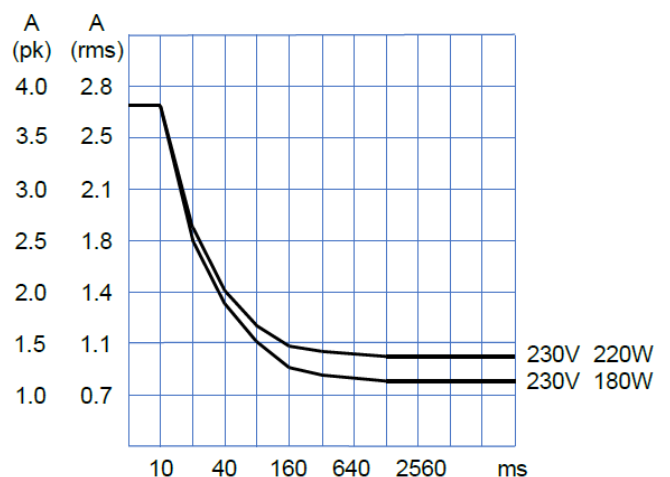
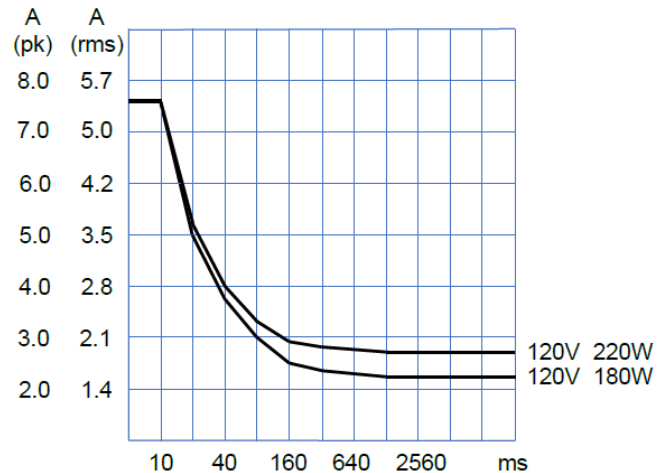



RECOMMENDED WIRING

	Input 12V	Input 24V	Input 36V	Input 48V	Input 72V	Input 110V	Output 120Vca	Output 230Vca
Max. Current [A]	23	14	10	7.4	5.0	3.2	2.2	1.2
Cable Section [mm ²]	2.5	1.5	1.5	1	0.75	0.75	0.75	0.75

INSTALLATION

There are two connecting options: spring clamp terminal strip and DIN-41612-H15 connector.

The product can be mounted in several ways:

- On a chassis by means of the 4 corner holes.
- In EUROCARD racks. For this application there is a standard 10Te front plate accessory **NP-9289**
- With the mounting base **NP-9125**. This accessory can be mounted on a chassis or in DIN rail adding the clip accessory **NP-9135**.

Make connections as shown in the CONNECTIONS table.

The default output frequency is 50Hz. For 60Hz simply actuate the dip-switch as indicated in the figure.

The inverter includes active overload protection but does not provide protection against prolonged reactive overload conditions. Therefore, the maximum power output (VA) should not be exceeded.

For safety reasons, the following requirements must be met:

- Provide the equipment with some kind of protective enclosure that complies with the electrical safety directives in effect within the country where the equipment is installed.
- Use cables of adequate cross-section to connect inputs and outputs. The following table lists the maximum currents and the minimum cross-sections for the cables used for each power connection.



DIMENSIONS

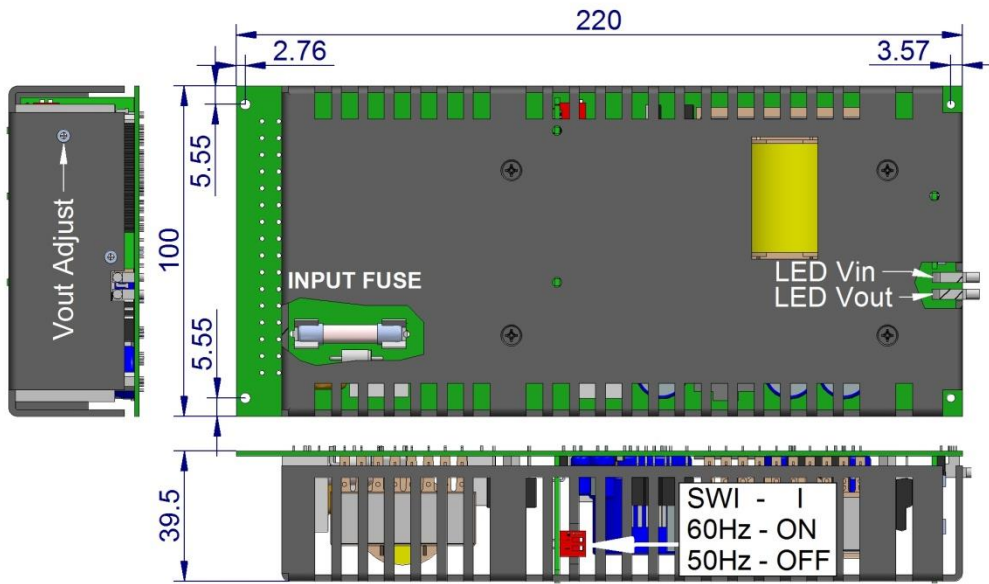

INPUT FUSE Size 6.3x32mm			
Models		Input	Rating
7031	7041	12V	T 30A
7033	7043	24V	T 15A
7034	7044	36V	T 12A
7035	7045	48V	T 8.0A
7036	7046	72V	T 6.3A
7037	7047	110V	T 4.0A

ACCESSORIES

ACCESSORIES	NOTES	CODE
Front plate 19" subrack (3U 10TE)	Screws and LED light guide included	NP-9289
Mounting base	Screws included	NP-9125
DIN RAIL CLIP	Screws included	NP-9135

NP-9289

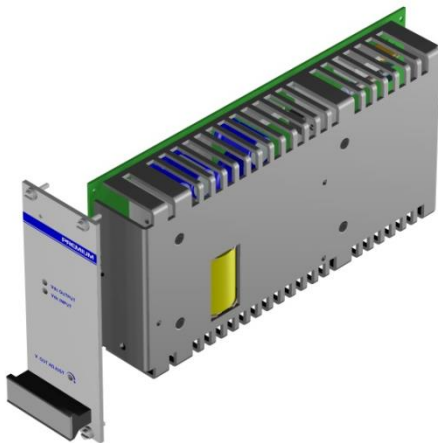

NP-9125

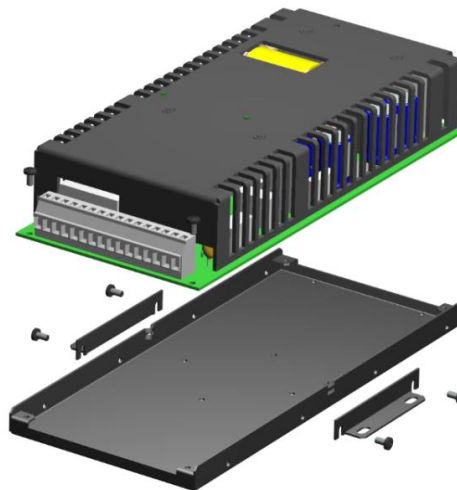

NP- 9135





CE|UK CA EU, UKCA DECLARATION OF CONFORMITY

The undersigned, representing the following:

Manufacturer: PREMIUM, S. A.,
Address: C/. Dolors Aleu 19-21, 08908 L'Hospitalet de Llobregat, SPAIN

herewith declares that the product:

Type: DC/AC Inverter
Models: **OCS-260-7031...7047**

is in conformity with the provisions of the following EU directive(s):

2014/35/EU SI 2016 No 1101	Low voltage / The electrical equipment (safety) regulations
2014/30/EU SI 2016 No 1091	EMC / Electromagnetic compatibility regulations
2015/863/EU SI 2012 No. 3032	RoHS / Restriction of the use of certain hazardous substances in electrical and electronic equipment

and that standards and/or technical specifications referenced below have been applied:

EN 60950: 2005	Safety (Information technology equipment)
EN 62368-1: 2014	Safety. Audio/video, information and communication technology equipment
EN 61000-6-4: 2019	Generic emission standard
EN 61000-6-2: 2005	Generic Immunity standard
EN 50155: 2017*	Railway applications. Electronic equipment used on rolling stock material
EN 50121-3-2: 2016*	Railway applications. EMC Rolling stock equipment

* Optional, see annexe

CE marking year: **2014**; UKCA marking year: **2021**

Notes:

For the fulfilment of this declaration the product must be used only for the aim that has been conceived, considering the limitations established in the instructions manual or datasheet.

L'Hospitalet de Llobregat, 31-05-2021

Albert Sole
Technical Director

PREMIUM S.A. is an ISO9001 and ISO14001
certified company by **Bureau Veritas**

ANNEXE

Applicable values for the different sections of the norm EN50155: 2017																																																												
4.3.1	Working altitude	Up to 1800m																																																										
4.3.2	Ambient temperature	Class OT1 (-25 to 55°C): load < 100% Class OT2 (-40 to 55°C): load < 100% (Without connectors handling) Class OT3 (-25 to 70°C): load < 50% Class OT4 (-40 to 70°C): load < 50% (Without Connectors handling)																																																										
4.3.3	Switch-on extended operating temp.	ST1																																																										
4.3.4	Rapid temperature variations	H1																																																										
4.3.5	Shocks and vibrations	According EN61373:2010 Category 1 class B																																																										
4.3.6	EMC Electromagnetic Compatibility EN50121-3-2:2016	<table border="1"> <thead> <tr> <th>Test</th> <th>Norm</th> <th>Port</th> <th>Frequency</th> <th>Limits</th> </tr> </thead> <tbody> <tr> <td rowspan="4">Radiated emissions</td> <td rowspan="4">IEC55016</td> <td rowspan="4">Case</td> <td>30MHz...230MHz</td> <td>40dB(µV/m) Qpk at 10m</td> </tr> <tr> <td>230MHz...1GHz</td> <td>47dB(µV/m) Qpk at 10m</td> </tr> <tr> <td>1...3GHz</td> <td>Do not apply</td> </tr> <tr> <td>3...6GHz</td> <td>Internal freq. < 108MHz</td> </tr> <tr> <td rowspan="2">Conducted emissions</td> <td rowspan="2">IEC55016</td> <td rowspan="2">Input</td> <td>150kHz...500kHz</td> <td>99dB(µV) Qpk</td> </tr> <tr> <td>500kHz...30MHz</td> <td>93dB(µV) Qpk</td> </tr> </tbody> </table>	Test	Norm	Port	Frequency	Limits	Radiated emissions	IEC55016	Case	30MHz...230MHz	40dB(µV/m) Qpk at 10m	230MHz...1GHz	47dB(µV/m) Qpk at 10m	1...3GHz	Do not apply	3...6GHz	Internal freq. < 108MHz	Conducted emissions	IEC55016	Input	150kHz...500kHz	99dB(µV) Qpk	500kHz...30MHz	93dB(µV) Qpk																																			
		Test	Norm	Port	Frequency	Limits																																																						
		Radiated emissions	IEC55016	Case	30MHz...230MHz	40dB(µV/m) Qpk at 10m																																																						
					230MHz...1GHz	47dB(µV/m) Qpk at 10m																																																						
					1...3GHz	Do not apply																																																						
					3...6GHz	Internal freq. < 108MHz																																																						
		Conducted emissions	IEC55016	Input	150kHz...500kHz	99dB(µV) Qpk																																																						
					500kHz...30MHz	93dB(µV) Qpk																																																						
		<table border="1"> <thead> <tr> <th>Test</th> <th>Norm</th> <th>Port</th> <th>Severity</th> <th>Conditions</th> <th>P</th> </tr> </thead> <tbody> <tr> <td rowspan="2">Electrostatic discharge</td> <td rowspan="2">IEC61000-4-2</td> <td rowspan="2">Case</td> <td>±8kV</td> <td>Air (isolated parts)</td> <td rowspan="2">B</td> </tr> <tr> <td>±8kV</td> <td>Contact (conductive parts)</td> </tr> <tr> <td rowspan="4">Radiated high-frequency</td> <td rowspan="4">IEC61000-4-3</td> <td rowspan="4">X/Y/Z Axis</td> <td>20V/m</td> <td>0.08...1.0GHz M. 80% 1kHz</td> <td rowspan="4">A</td> </tr> <tr> <td>10V/m</td> <td>1.4...2.1GHz M. 80% 1kHz</td> </tr> <tr> <td>5V/m</td> <td>2.1...2.5GHz M. 80% 1kHz</td> </tr> <tr> <td>3V/m</td> <td>5.1...6Ghz M. 80% 1kHz</td> </tr> <tr> <td rowspan="4">Fast transients</td> <td rowspan="4">IEC61000-4-4</td> <td>Input</td> <td>±2kV</td> <td rowspan="4">Tr/Th: 5/50 ns</td> <td rowspan="4">A</td> </tr> <tr> <td>Output</td> <td>±2kV</td> </tr> <tr> <td>Signal</td> <td>±2kV</td> </tr> <tr> <td>PE</td> <td>±1kV</td> </tr> <tr> <td rowspan="2">Surge</td> <td rowspan="2">IEC61000-4-5</td> <td>Input L to L</td> <td>±1kV</td> <td rowspan="2">Tr/Th: 1.2/50µs</td> <td rowspan="2">B</td> </tr> <tr> <td>Input L to PE</td> <td>±2kV</td> </tr> <tr> <td rowspan="4">Conducted RF</td> <td rowspan="4">IEC61000-4-6</td> <td>Input</td> <td>10V</td> <td rowspan="4">0.15...80MHz M. 80% 1kHz</td> <td rowspan="4">A</td> </tr> <tr> <td>Output</td> <td>10V</td> </tr> <tr> <td>Signal</td> <td>10V</td> </tr> <tr> <td>PE</td> <td>10V</td> </tr> </tbody> </table>	Test	Norm	Port	Severity	Conditions	P	Electrostatic discharge	IEC61000-4-2	Case	±8kV	Air (isolated parts)	B	±8kV	Contact (conductive parts)	Radiated high-frequency	IEC61000-4-3	X/Y/Z Axis	20V/m	0.08...1.0GHz M. 80% 1kHz	A	10V/m	1.4...2.1GHz M. 80% 1kHz	5V/m	2.1...2.5GHz M. 80% 1kHz	3V/m	5.1...6Ghz M. 80% 1kHz	Fast transients	IEC61000-4-4	Input	±2kV	Tr/Th: 5/50 ns	A	Output	±2kV	Signal	±2kV	PE	±1kV	Surge	IEC61000-4-5	Input L to L	±1kV	Tr/Th: 1.2/50µs	B	Input L to PE	±2kV	Conducted RF	IEC61000-4-6	Input	10V	0.15...80MHz M. 80% 1kHz	A	Output	10V	Signal	10V	PE	10V
		Test	Norm	Port	Severity	Conditions	P																																																					
Electrostatic discharge	IEC61000-4-2	Case	±8kV	Air (isolated parts)	B																																																							
			±8kV	Contact (conductive parts)																																																								
Radiated high-frequency	IEC61000-4-3	X/Y/Z Axis	20V/m	0.08...1.0GHz M. 80% 1kHz	A																																																							
			10V/m	1.4...2.1GHz M. 80% 1kHz																																																								
			5V/m	2.1...2.5GHz M. 80% 1kHz																																																								
			3V/m	5.1...6Ghz M. 80% 1kHz																																																								
Fast transients	IEC61000-4-4	Input	±2kV	Tr/Th: 5/50 ns	A																																																							
		Output	±2kV																																																									
		Signal	±2kV																																																									
		PE	±1kV																																																									
Surge	IEC61000-4-5	Input L to L	±1kV	Tr/Th: 1.2/50µs	B																																																							
		Input L to PE	±2kV																																																									
Conducted RF	IEC61000-4-6	Input	10V	0.15...80MHz M. 80% 1kHz	A																																																							
		Output	10V																																																									
		Signal	10V																																																									
		PE	10V																																																									
		P= Performance criteria, L= Line, PE= Protective Earth																																																										
4.3.7	Relative humidity	Up to 95%																																																										
5.1.1.2	DC power supply range	From 0.70 to 1.25 Un continuous																																																										
5.1.1.3	Temporary DC power supply fluctuation	From 0.60 to 1.40 Un 0.1s From 1.25 to 1.40 Un 1s without damage																																																										
5.1.1.4	Interruptions of voltage supply	Class S1 (without interruptions)																																																										
5.1.1.6	Input ripple factor	10% peak to peak with a DC Ripple Factor of 5 %																																																										
5.1.3	Supply change-over	0,6 Un duration 100 ms (without interruptions). Performance criterion A																																																										
7.2.7	Input reverse polarity protection	By fuse																																																										
10.7	Protective coating for PCB assemblies	Class PC2																																																										
13.3	Tests list	<table border="0"> <tbody> <tr><td>1 Visual Inspection</td><td>Routine</td></tr> <tr><td>2 Performance test</td><td>Routine</td></tr> <tr><td>3 Power supply test</td><td>Routine</td></tr> <tr><td>4 Insulation test</td><td>Routine</td></tr> <tr><td>5 Low temperature storage test</td><td>-</td></tr> <tr><td>6 Low temperature start-up test</td><td>Type</td></tr> <tr><td>7 Dry heat test</td><td>Type</td></tr> <tr><td>8 Cyclic damp heat test</td><td>Type</td></tr> <tr><td>9 Salt mist test</td><td>-</td></tr> <tr><td>10 Enclosure protection test (IP code)</td><td>-</td></tr> <tr><td>11 EMC test</td><td>Type</td></tr> <tr><td>12 Shocks and vibrations test</td><td>Type</td></tr> <tr><td>13 Equipment stress screening test</td><td>Routine: 24h at 40°C and load</td></tr> <tr><td>14 Rapid Temperature variation test</td><td>100%</td></tr> <tr><td></td><td>Type</td></tr> </tbody> </table>	1 Visual Inspection	Routine	2 Performance test	Routine	3 Power supply test	Routine	4 Insulation test	Routine	5 Low temperature storage test	-	6 Low temperature start-up test	Type	7 Dry heat test	Type	8 Cyclic damp heat test	Type	9 Salt mist test	-	10 Enclosure protection test (IP code)	-	11 EMC test	Type	12 Shocks and vibrations test	Type	13 Equipment stress screening test	Routine: 24h at 40°C and load	14 Rapid Temperature variation test	100%		Type																												
1 Visual Inspection	Routine																																																											
2 Performance test	Routine																																																											
3 Power supply test	Routine																																																											
4 Insulation test	Routine																																																											
5 Low temperature storage test	-																																																											
6 Low temperature start-up test	Type																																																											
7 Dry heat test	Type																																																											
8 Cyclic damp heat test	Type																																																											
9 Salt mist test	-																																																											
10 Enclosure protection test (IP code)	-																																																											
11 EMC test	Type																																																											
12 Shocks and vibrations test	Type																																																											
13 Equipment stress screening test	Routine: 24h at 40°C and load																																																											
14 Rapid Temperature variation test	100%																																																											
	Type																																																											