

Features

- High contact capability : 12A switching capability.
- Low coil power consumption, low price.
- Microminiature relay, standard PCB terminal.
- Satisfy IEC60335-1 product is available.
- Satisfy IEC60079-15 product is available.



Safety Approval

UL , C-UL File No. : E190598

TUV File No. : R50142424

CQC File No. : CQC02001002126

VDE File No.: 40034479

Contact Capacity

Model	SRD -DM	SRD -D	SRD-DB
Nominal switching capacity (res. load)	10A 250VAC	NO10A 250VAC NO/NC7A 250VAC	7A 250VAC
Max. switching current	15A	12A	12A
Max. switching voltage	277VAC	277VAC	277VAC
Max. switching power	2,770VA	2,770VA	1,939VA

Characteristic Data

Contact material	Silver alloy	
Initial contact resistance (at 6VDC 1A)	100mΩ Max. (1A 6VDC)	
Operate time (at nominal volt.)	8msec. Max. (no diode)	
Release time (at nominal volt.)	5msec. Max. (no diode)	
Initial insulation resistance	1000MΩ Min. (DC500V)	
Initial dielectric strength	Between open contacts : AC750V , 50/60Hz 1min.	
	Between coil and contact : AC1,500V , 50/60Hz 1min.	
Vibration resistance	Functional	10 ~ 55Hz at double amplitude of 1.5 mm
	Destructive	10 ~ 55Hz at double amplitude of 1.5 mm
Shock resistance	Functional	10G Min.
	Destructive	100G Min.
Endurance (operations)	Mechanical (at 10,800 ops./h)	10,000,000 cycles (at room temperature)
	Electrical (at 360 ops./h)	100,000 cycles (at room temperature)
Ambient temperature	-40°C ~ +85°C (no condensation) Please contact us if your working condition is 105°C	
Unit weight	Approx. 8.5 g	

Coil Data (at 20°C)

Nominal voltage (VDC)	Nominal operating current 10% (mA)	Coil resistance 10% (Ω)	.Max allowable voltage	Pick-up voltage (Max.)	Drop-out voltage (Min.)	Nominal operating power
3	120.00	25	130 % of nominal voltage	75 % of nominal voltage	5 % of nominal voltage	0.36W
5	71.42	70				
6	60.00	100				
9	40.00	225				
12	30.00	400				
15	24.00	625				
18	20.00	900				
24	15.00	1,600				
48	7.50	6,400				
60	6.00	10,000				

Safety Approval Ratings

(Note:More detail of approval ratings,please refer to the safety certification)

Approval	CQC	TUV	VDE	UL/CUL
File No.	CQC02001002126	R50142424	40034479	E190598
Approved ratings	7A 250VAC 5A 240VAC 10A 250VAC (Form A & Form C NO)	7A 250VAC 7A 28VDC 10A 250VAC (Form A)	Contact 2 or blank: 10A 250VAC(Form C,NO) 7A 250VAC(Form C,NO) 6A 250VAC(Form C , NC) Contact 2 or blank: 10A 250VAC(Form A) 7A 250VAC(Form A) Contact 3: 10A 250VAC(Form C,NO) 7A 250VAC(Form C,NO) 6A 250VAC(Form C , NC) Contact 3: 10A 250VAC(Form A) 7A 250VAC(Form A)	contact code 2 (Form C)or Nil(Form A or Form B) : 12A 125VAC,Resistive,NO&NC 15A 125VAC,Resistive,NO 10A 250VAC,Resistive,No 7A 250VAC,General use,NO&NC 3A 125VAC,General use NO&NC 10A/6A 250VAC ,General use NO/NC 10A/6A 125VAC ,General use NO/NC 10A/6A 28VDC ,General use NO/NC 1/3 HP 250VAC,NO&NC FLA 5A,LRA 10A,120/240VAC,NO Pilot duty:240VA,240VAC TV-3 120VAC,NO TV-5,120VAC,NO contact code 2(Form A or Form B)or Nil (Form C) : 12A/15A 125VAC,General use&Resistive,NO 10A 250VAC/28VDC,General use&Resistive,NO 1/3 HP 250VAC,NO FLA 5A,LRA 10A,120/240VAC,NO TV-3 120VAC,NO contact code1 or 3 : 12A/15A 125VAC,General use&Resistive,NO 10A 250VAC/28VDC,General use&Resistive,NO 1/3 HP 250VAC,NO FLA 5A,LRA 10A,120/240VAC,NO TV-3 120VAC,NO contact code 4 : 7A 250VAC,General use&Resistive,NO&NC 7A 250VAC,General use&Resistive,NO contact code 5 : 7A 250VAC,General use&Resistive,NO&NC 7A 250VAC,General use&Resistive,NO contact code 6(Form A or Form C) : 10A 277 VAC,Resistive&General use,NO 7A 277 VAC,Resistive&General use,NC

- (1) The above-mentioned unspecified temperature ratings, means that the ambient temperature is room temperature.
- (2) Only some typical ratings are listed above. Each rating's test condition is different, so the electrical endurance will be different. If more details are required, please contact us.
- (3) For sealed type testing, please open the ventilation hole of case before test.

Ordering Information

Nomenclature									
SRD	- S	- 1	12	D	M	1	- F	- XX	Special Parameter : Nil-Standard type Letters or Numbers-Special requirements
Insulation System : Nil-Standard, B-Class B, F-Class F									
Contact Material :									
Moveable Contact for form C			Moveable Contact for form A			Moveable Contact for form B			
Nil-AgSnO ₂ φ2.8			Nil-AgSnO ₂ φ3.0			Nil-AgSnO ₂ φ3.0			
1- AgCdO φ2.8			1-AgCdO φ3.0			1-AgCdO φ3.0			
2-AgSnO ₂ φ3.0			6-AgNi φ3.0						
3- AgCdO φ3.0									
4-3 Compounds φ3.0									
5-Cu plated with La φ3.0									
6-AgNi φ3.0									
Contact Form : Nil-Form C, B-Form B, M-Form A									
Coil Power : D-0.36W									
Coil Voltage (VDC) : 03, 05, 06, 09, 12, 15, 18, 24, 48, 60									
Number of Poles : 1-1 Pole									
Protective Construction : S-Flux proofed, SH-Sealed type washable									
Type Designation : SRD									

Notes : (1)Dust covers with the marking of "VDE" are just for intend products with the suffixs of "D", "D2", "D3", "D6", "DM"and"DM6".
 (2)All stationary contacts are specified as : φ3.0

Outline Dimensions, Wiring Diagram, P.C. Board Layout (unit : mm)

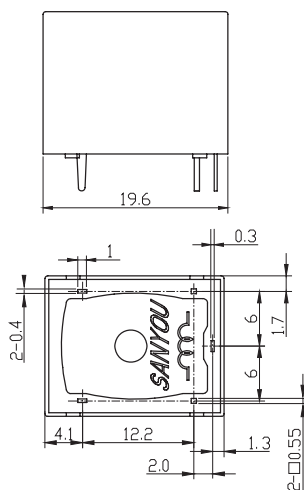

Unless otherwise specified :
 If dimension < 1mm, tolerance : 0.2 mm;
 If dimension 1~5mm, tolerance : 0.3 mm;
 If dimension > 5mm, tolerance : 0.4 mm.
 Note : Extended terminal dimension is dimension before soldering.
 Tolerance of P.C.B. layout : 0.1 mm.

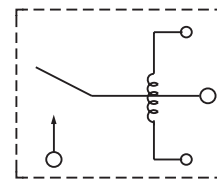
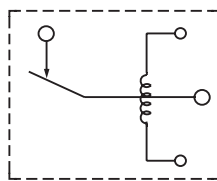
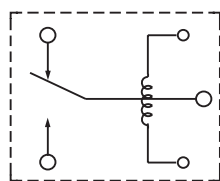

Wiring Diagram (bottom view)

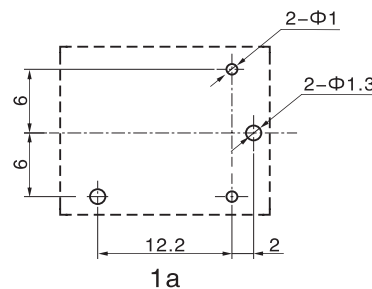
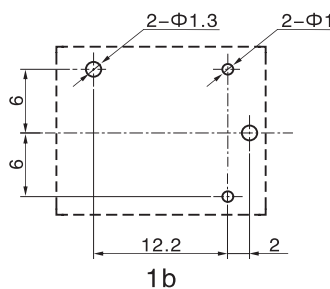
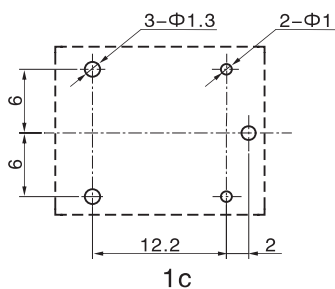

P.C.B. Layout (bottom view)

Tolerance of P.C.B. layout : 0.1 mm.

Typical Applications

- Home appliances such as air conditioner, heater, etc.
- Automat • Office equipment such as computer, fax machine, etc.
- Automatic electric controlled window, automotive antenna, door lock, etc.

Characteristic Curves

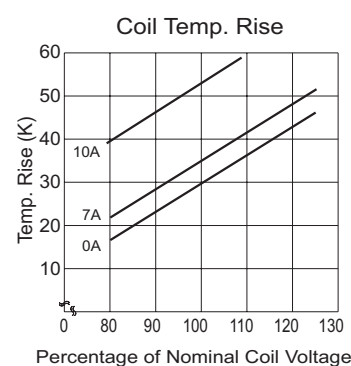
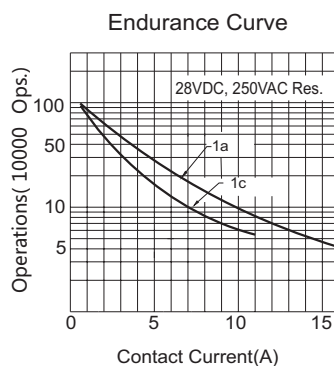
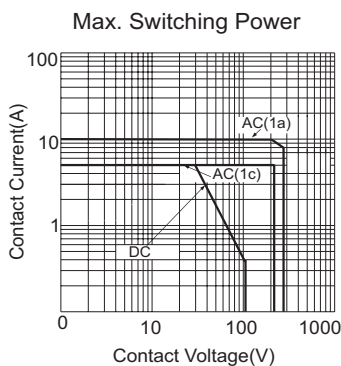

Disclaimer:

This datasheet is the customers' reference. All the specification are subject to change without notice.
 We could not evaluate all the performance and all the parameters for every possible application. Thus the user should in a right position to choose the suitable product for their own application. For sealed relays after installation and cleaning, please open the vent hole on the case before use. If there is any query, please contact Sanyou for the technical service. However it is the user's responsibility to determine which product should be used only.