



ANT-LPC-FPC-ccc

LTE/LPWA/GNSS Flexible Embedded Dipole Antenna

The ANT-LPC-FPC-ccc (LPC) antenna is a flexible embedded multiband cellular and cellular IoT antenna (LTE-M and NB-IoT) ideal for use in LTE applications such as Citizens Broadband Radio Service (CBRS). The LPC also supports low-power, wide-area (LPWA) networking at 868 MHz, 915 MHz and global navigation systems (GNSS/GPS).

The LPC provides a ground plane independent dipole embedded antenna solution comparable in performance to an external antenna. The LPC's flexibility and adhesive backing makes it easy to mount in unique and custom enclosures, while enabling an environmentally sealed enclosure and protection from tampering or accidental antenna damage.

Connection is made to the radio via 1.13 mm coaxial cable terminated in an MHF1/U.FL-type plug connector.

FEATURES

- 3550 MHz to 3700 MHz (CBRS)
 - VSWR: ≤ 4.5
 - Peak Gain: 5.5 dBi
 - Efficiency: 70%
- 2496 MHz to 2690 MHz (LTE 7, 41)
 - VSWR: ≤ 3.1
 - Peak Gain: 5.0 dBi
 - Efficiency: 59%
- Compact, low-profile
 - 64 mm x 17 mm x 0.2 mm
- MHF1/U.FL-type plug (female socket) on 1.13 mm coaxial cable
- Flexible to fit in challenging enclosures
- Adhesive backing permanently adheres to non-metal enclosures using 3M 467MP™/200MP adhesive

APPLICATIONS

- Worldwide LTE, UMTS and GSM
- Cellular IoT:
 - LTE-M (Cat-M1)
 - NB-IoT
- Low-power, wide-area (LPWA) applications
 - LoRaWAN®
 - Sigfox®
- ISM: Bluetooth® and ZigBee®
 - Global Navigation (GNSS)
- GPS, Galileo, BeiDou
- Citizens Broadband Radio Service (CBRS)

ORDERING INFORMATION

Part Number	Description
ANT-LPC-FPC-50	Antenna with 50 mm of 1.13 mm coaxial cable and MHF1/U.FL-type plug (female socket)
ANT-LPC-FPC-100	Antenna with 100 mm of 1.13 mm coaxial cable and MHF1/U.FL-type plug (female socket)
ANT-LPC-FPC-150	Antenna with 150 mm of 1.13 mm coaxial cable and MHF1/U.FL-type plug (female socket)

Available from Linx Technologies and select distributors and representatives.

TABLE 1. ELECTRICAL SPECIFICATIONS

Select Bands	Frequency Range	VSWR (max.)	Peak Gain (dBi)	Avg. Gain (dBi)	Efficiency (%)
LTE 12, 13, 14, 17, 26, 28, 29	698 MHz to 803 MHz	8.2	0.1	-6.4	25
LTE 5, 8, 20	791 MHz to 960 MHz	4.8	3.7	-4.5	43
LTE 1, 2, 3, 4, 10, 25, 66	1710 MHz to 2200 MHz	4.9	2.2	-3.6	49
LTE 30, 40	2300 MHz to 2400 MHz	3.5	3.3	-2.8	53
LTE 7, 41	2496 MHz to 2690 MHz	3.1	5.0	-2.7	59
LTE 22, 42, 43, 48, 49, 52	3300 MHz to 3800 MHz	2.0	5.7	-1.8	70
GNSS/GPS	1553 MHz to 1609 MHz	1.7	3.3	-1.5	72
ISM	2400 MHz to 2485 MHz	2.7	3.9	-4.1	43
Polarization	Linear				
Radiation	Omnidirectional				
Max Power	2 W				
Wavelength	1/2-wave				
Electrical Type	Dipole				
Impedance	50 Ω				
ESD Sensitivity	NOT ESD sensitive. As a best practice, Linx may use ESD packaging.				

Electrical specifications and plots measured on a 2.0 mm (0.08 in) thick plastic sheet

TABLE 2. MECHANICAL SPECIFICATIONS

Part Number	Connection	Coaxial Cable, minimum inside bend radius	Weight
ANT-LPC-FPC-50	MHF1/U.FL-type plug	1.13 mm: 5.0 mm (0.20 in)	50 mm = 0.7 g (0.02 oz)
ANT-LPC-FPC-100	MHF1/U.FL-type plug	1.13 mm: 5.0 mm (0.20 in)	100 mm = 0.8 g (0.03 oz)
ANT-LPC-FPC-150	MHF1/U.FL-type plug	1.13 mm: 5.0 mm (0.20 in)	150 mm = 1.0 g (0.03 oz)
Operating Temp. Range	-40 °C to +85 °C		
Dimensions	64.0 mm x 17.0 mm x 0.2 mm (2.52 in x 0.67 in x 0.01 in)		

PRODUCT DIMENSIONS

Figure 1 shows the overall dimensions for the LPC antenna.

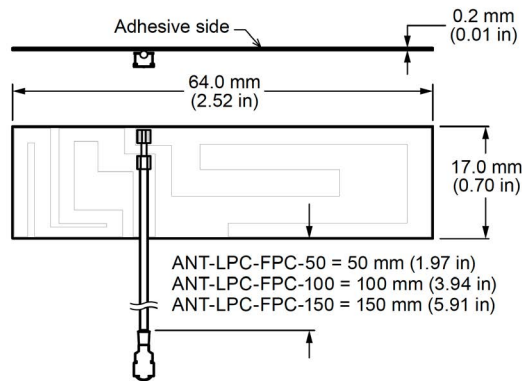

Figure 1: ANT-LPC-FPC-ccc Antenna Dimensions

PACKAGING INFORMATION

The ANT-LPC-FPC-ccc antenna is placed in a clear plastic sleeve, and packaged in sealed plastic bags of of 10 pcs. Distribution channels may offer alternative packaging options.

ANTENNA MOUNTING

The ANT-LPC-FPC-ccc is a flexible, adhesive backed antenna that allows it to be permanently installed onto non-metallic surfaces. The adhesive backing is 3M 467MP™/200MP, which provides outstanding adhesion to high surface energy plastics. The adhesive delivers excellent shear strength to resist slippage and edge lifting, but can be repositioned temporarily to allow for repositioning. This adhesive is highly resistant to solvents, humidity and moisture, as well as heat up to 204 °C (400 °F) for short periods.

VSWR

The ANT-LPC-FPC-ccc is a flexible, adhesive backed antenna that allows it to be permanently installed onto non-metallic surfaces. The adhesive backing is 3M 467MP™/200MP, which provides outstanding adhesion to high surface energy plastics. The adhesive delivers excellent shear strength to resist slippage and edge lifting, but can be repositioned temporarily to allow for repositioning. This adhesive is highly resistant to solvents, humidity and moisture, as well as heat up to 204 °C (400 °F) for short periods.

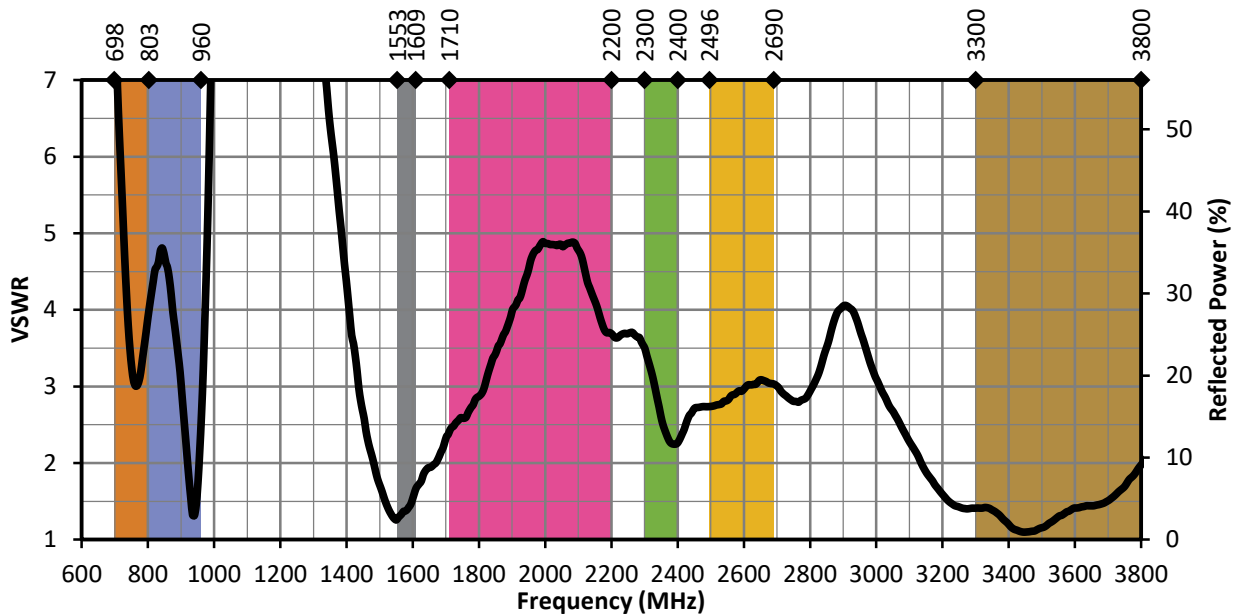

Figure 2: LPC Antenna VSWR with Frequency Band Highlights

RETURN LOSS

Return loss (Figure 3), represents the loss in power at the antenna due to reflected signals. Like VSWR, a lower return loss value indicates better antenna performance at a given frequency.

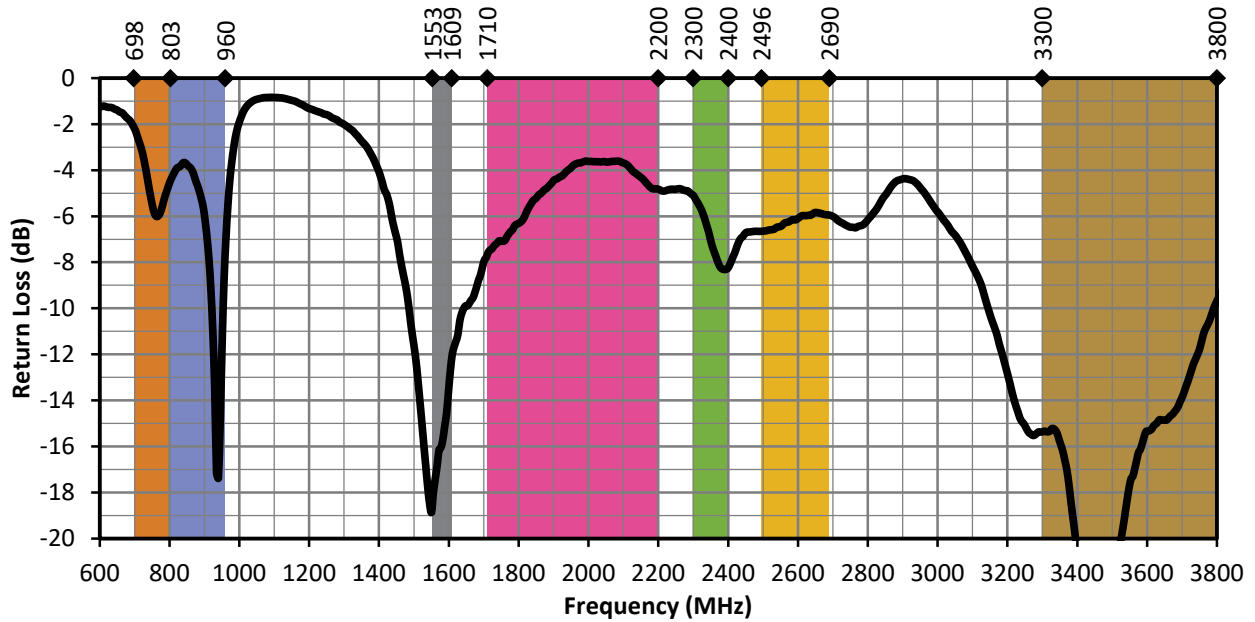

Figure 3. LPC Antenna Return Loss with Frequency Band Highlights

PEAK GAIN

The peak gain across the antenna bandwidth is shown in Figure 4. Peak gain represents the maximum antenna input power concentration across 3-dimensional space, and therefore peak performance, at a given frequency, but does not consider any directionality in the gain pattern.

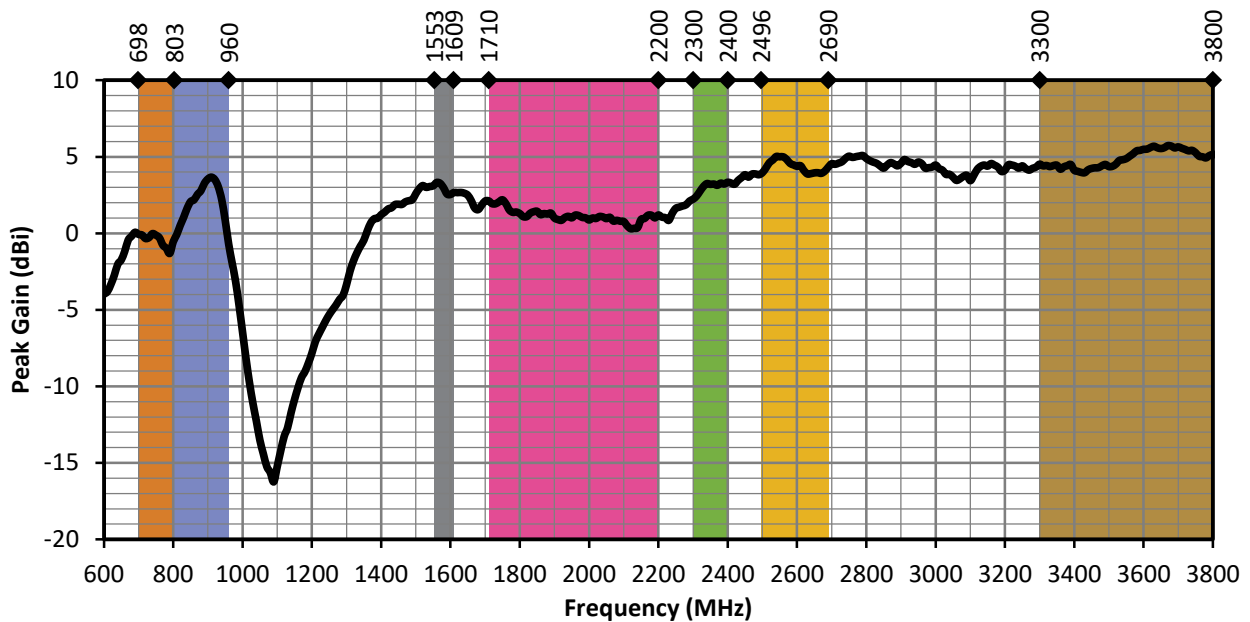

Figure 4. LPC Antenna Return Loss with Frequency Band Highlights

AVERAGE GAIN

Average gain (Figure 5), is the average of all antenna gain in 3-dimensional space at each frequency, providing an indication of overall performance without expressing antenna directionality.

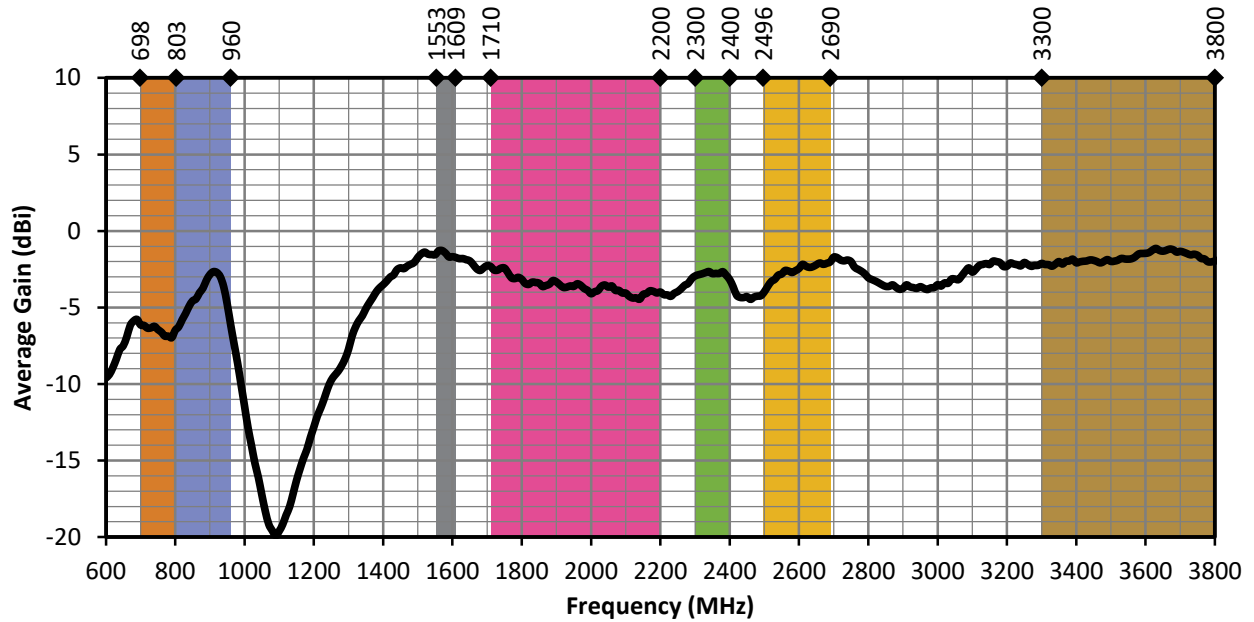

Figure 5. LPC Antenna Average Gain with Frequency Band Highlights

RADIATION EFFICIENCY

Radiation efficiency (Figure 6), shows the ratio of power delivered to the antenna relative to the power radiated at the antenna, expressed as a percentage, where a higher percentage indicates better performance at a given frequency.

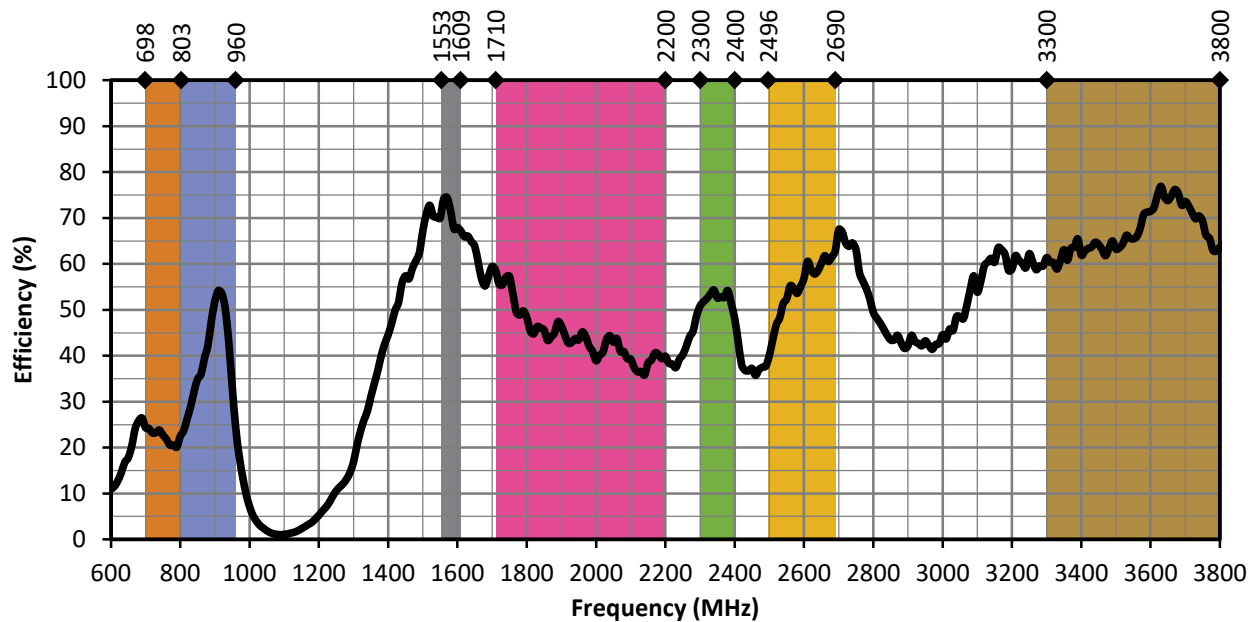
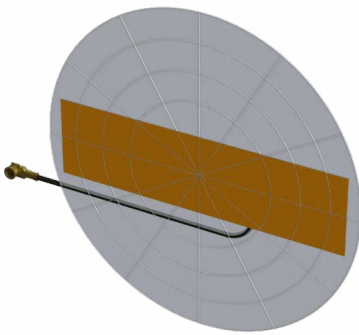

Figure 6. LPC Antenna Radiation Efficiency with Frequency Band Highlights

RADIATION PATTERNS

Radiation patterns provide information about the directionality and 3-dimensional gain performance of the antenna by plotting gain at specific frequencies in three orthogonal planes. Antenna radiation patterns (Figure 7), are shown using polar plots covering 360 degrees. The antenna graphic above the plots provides reference to the plane of the column of plots below it. Note: when viewed with typical PDF viewing software, zooming into radiation patterns is possible to reveal fine detail.



XZ-Plane Gain

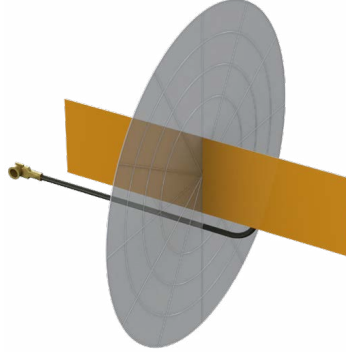

YZ-Plane Gain

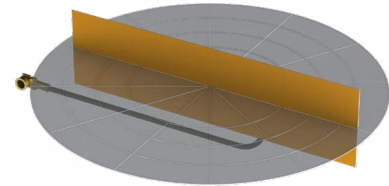

XY-Plane Gain

698 MHz TO 803 MHz (750 MHz)

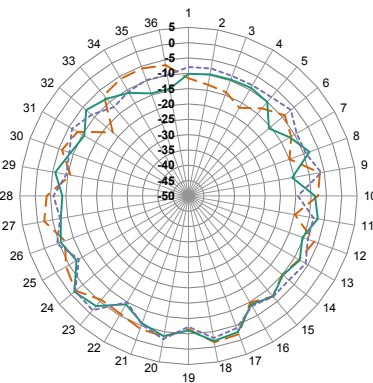

XZ-Plane Gain

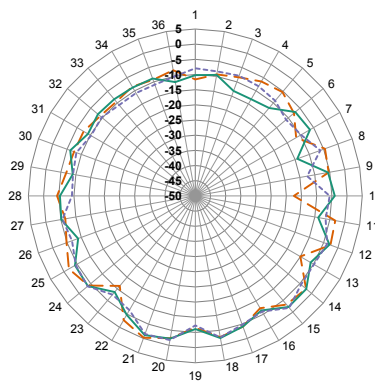

YZ-Plane Gain

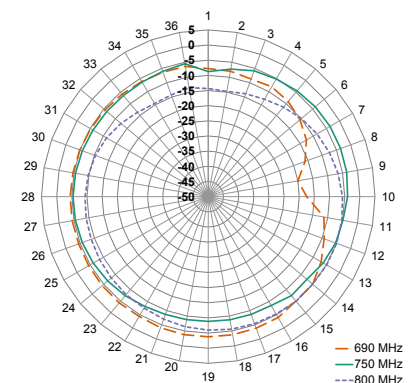

XY-Plane Gain

790 MHz TO 960 MHz (870 MHz)

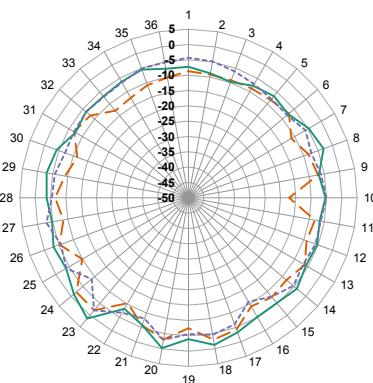

XZ-Plane Gain

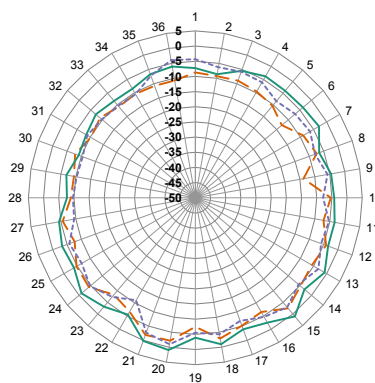

YZ-Plane Gain

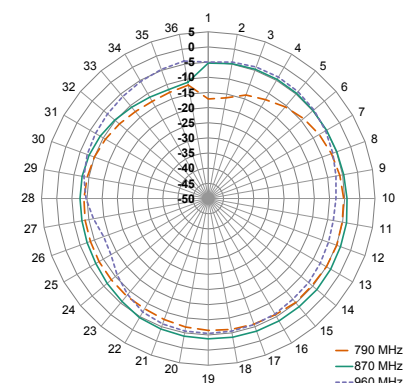

XY-Plane Gain

1710 MHz TO 2200 MHz (1950 MHz)

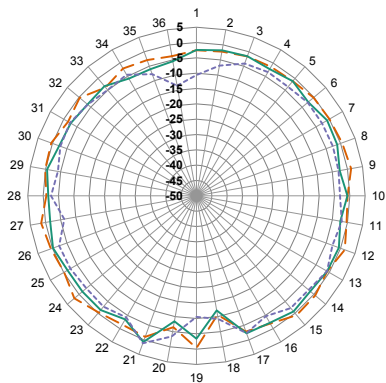

XZ-Plane Gain

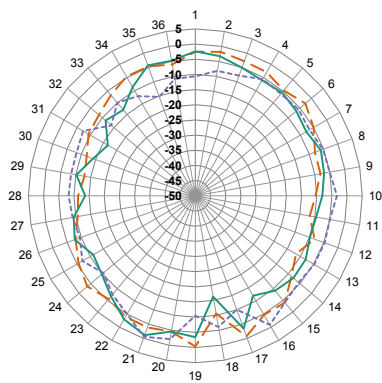

YZ-Plane Gain

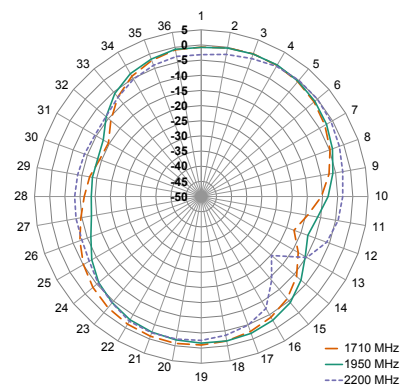

XY-Plane Gain

2300 MHz TO 2400 MHz (2350 MHz)

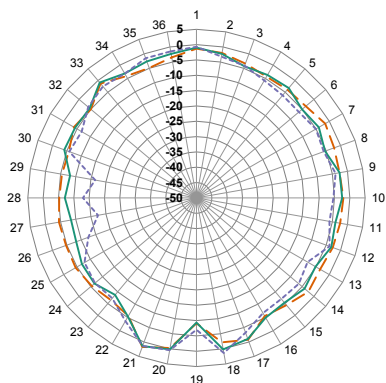

XZ-Plane Gain

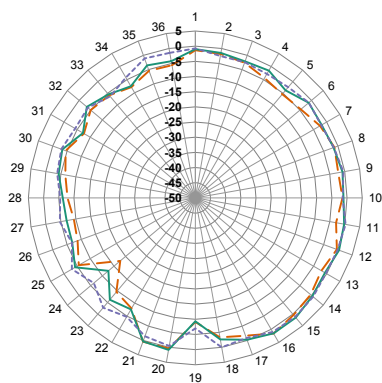

YZ-Plane Gain

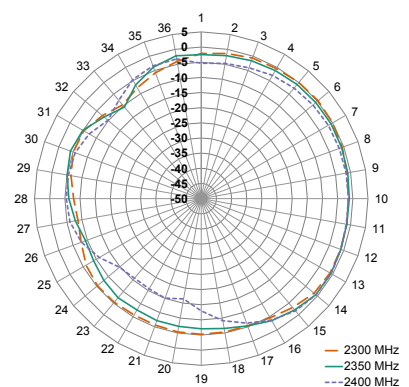

XY-Plane Gain

2496 MHz TO 2690 MHz (2600 MHz)

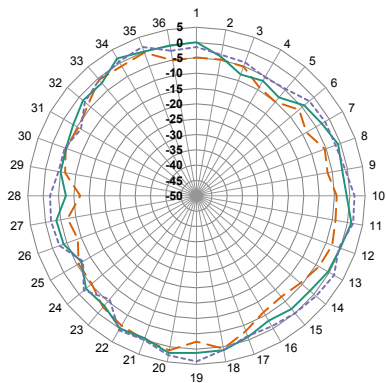

XZ-Plane Gain

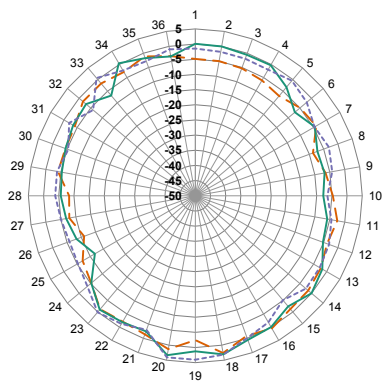

YZ-Plane Gain

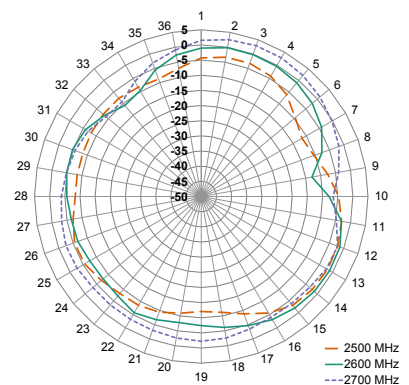

XY-Plane Gain

3300 MHz TO 3800 MHz (3550 MHz)

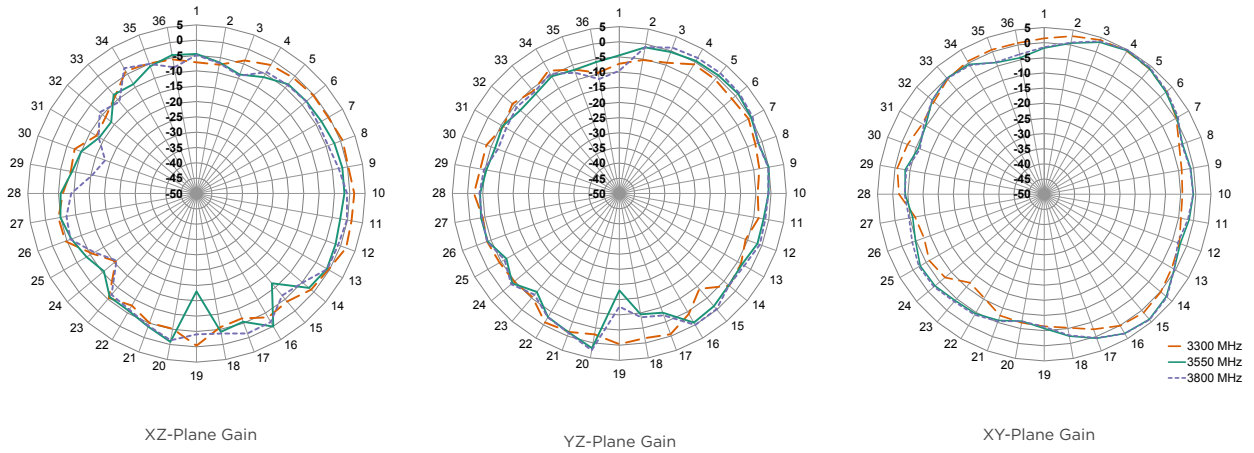

1560 MHz TO 1610 MHz (1580 MHz)

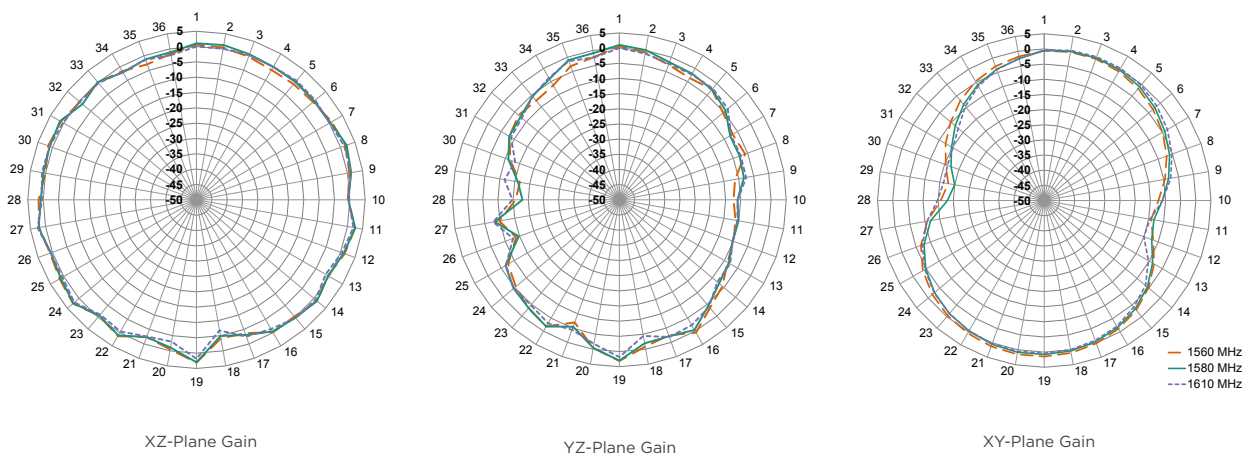

2400 MHz TO 2490 MHz (2450 MHz)

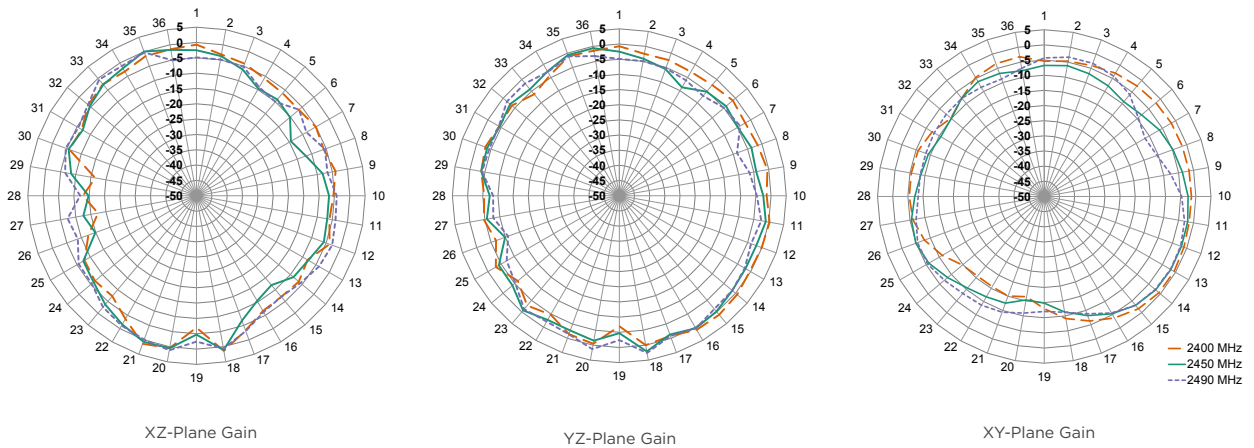

Figure 7. Radiation Patterns for ANT-LPC-FPC-ccc Antenna

ANTENNA DEFINITIONS AND USEFUL FORMULAS

VSWR - Voltage Standing Wave Ratio. VSWR is a unitless ratio that describes the power reflected from the antenna back to the radio. A lower VSWR value indicates better antenna performance at a given frequency. VSWR is easily derived from Return Loss.

$$\text{VSWR} = \frac{10^{\left[\frac{\text{Return Loss}}{20}\right]} + 1}{10^{\left[\frac{\text{Return Loss}}{20}\right]} - 1}$$

Return Loss - Return loss represents the loss in power at the antenna due to reflected signals, measured in decibels. A lower return loss value indicates better antenna performance at a given frequency. Return Loss is easily derived from VSWR.

$$\text{Return Loss} = -20 \log_{10} \left[\frac{\text{VSWR} - 1}{\text{VSWR} + 1} \right]$$

Efficiency (η) - The total power radiated from an antenna divided by the input power at the feed point of the antenna as a percentage.

Total Radiated Efficiency - (TRE) The total efficiency of an antenna solution comprising the radiation efficiency of the antenna and the transmitted (forward) efficiency from the transmitter.

$$\text{TRE} = \eta \cdot \left(1 - \left(\frac{\text{VSWR} - 1}{\text{VSWR} + 1} \right)^2 \right)$$

Gain - The ratio of an antenna's efficiency in a given direction (G) to the power produced by a theoretical lossless (100% efficient) isotropic antenna. The gain of an antenna is almost always expressed in decibels.

$$G_{\text{db}} = 10 \log_{10}(G)$$

$$G_{\text{dBd}} = G_{\text{dBi}} - 2.51\text{dB}$$

Peak Gain - The highest antenna gain across all directions for a given frequency range. A directional antenna will have a very high peak gain compared to average gain.

Average Gain - The average gain across all directions for a given frequency range.

Maximum Power - The maximum signal power which may be applied to an antenna feed point, typically measured in watts (W).

Reflected Power - A portion of the forward power reflected back toward the amplifier due to a mismatch at the antenna port.

$$\left(\frac{\text{VSWR} - 1}{\text{VSWR} + 1} \right)^2$$

decibel (dB) - A logarithmic unit of measure of the power of an electrical signal.

decibel isotropic (dBi) - A comparative measure in decibels between an antenna under test and an isotropic radiator.

decibel relative to a dipole (dBd) - A comparative measure in decibels between an antenna under test and an ideal half-wave dipole.

Dipole - An ideal dipole comprises a straight electrical conductor measuring 1/2 wavelength from end to end connected at the center to a feed point for the radio.

Isotropic Radiator - A theoretical antenna which radiates energy equally in all directions as a perfect sphere.

Omnidirectional - Term describing an antenna radiation pattern that is uniform in all directions. An isotropic antenna is the theoretical perfect omnidirectional antenna. An ideal dipole antenna has a donut-shaped radiation pattern and other practical antenna implementations will have less perfect but generally omnidirectional radiation patterns which are typically plotted on three axes.

TE TECHNICAL SUPPORT CENTER

USA:	+1 (800) 522-6752
Canada:	+1 (905) 475-6222
Mexico:	+52 (0) 55-1106-0800
Latin/S. America:	+54 (0) 11-4733-2200
Germany:	+49 (0) 6251-133-1999
UK:	+44 (0) 800-267666
France:	+33 (0) 1-3420-8686
Netherlands:	+31 (0) 73-6246-999
China:	+86 (0) 400-820-6015

te.com

TE Connectivity, TE, TE connectivity (logo), Linx and Linx Technologies are trademarks owned or licensed by the TE Connectivity Ltd. family of companies. All other logos, products and/or company names referred to herein might be trademarks of their respective owners.

The information given herein, including drawings, illustrations and schematics which are intended for illustration purposes only, is believed to be reliable. However, TE Connectivity makes no warranties as to its accuracy or completeness and disclaims any liability in connection with its use. TE Connectivity's obligations shall only be as set forth in TE Connectivity's Standard Terms and Conditions of Sale for this product and in no case will TE Connectivity be liable for any incidental, indirect or consequential damages arising out of the sale, resale, use or misuse of the product. Users of TE Connectivity products should make their own evaluation to determine the suitability of each such product for the specific application.

TE Connectivity warrants to the original end user customer of its products that its products are free from defects in material and workmanship. Subject to conditions and limitations TE Connectivity will, at its option, either repair or replace any part of its products that prove defective because of improper workmanship or materials. This limited warranty is in force for the useful lifetime of the original end product into which the TE Connectivity product is installed. Useful lifetime of the original end product may vary but is not warranted to exceed one (1) year from the original date of the end product purchase.

©2022 TE Connectivity. All Rights Reserved.

09/22 Original