

P.C.B LAYOUT

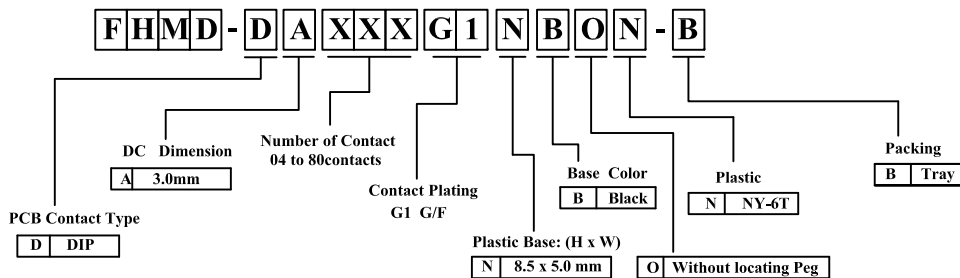

Temperature Rating : -40°C ~ +125°C .
Dielectric Withstanding Voltage : 1000V AC/Min .

REV.	DESCRIPTION	DATE
A	New Drawing	2010/02/08

LTR	Part Name	Material	Description	QTY
1	Housing	Nylon UL94V-0	260°C for 10 Seconds . Initial : 1000M Ohms Min. After Test : 500M Ohms Min.	1
2	Contact	Brass	Current Rating : 3.0A Initial : 20m Ohms Max. After Test : 40m Ohms Max.	xx

Superior Tech Co., Ltd.

General Tolerance		TITLE 2.54x2.54mm Female Header Dual Row DIP Type		
X. ± 0.5	DRAWN	DATE	NO.	
.X ± 0.3	Zhanghonglan	02-08-10'	002	
.XX ± 0.2	CHECK	DATE	PART NO.	
.XXX ± 0.1	APPROVED	DATE	FHMD-DAXXXG1NBON-B	
Angle ± 5°			CUSTOMER NO.	
			DK	

REV.	UNIT	SCALE
A	mm	3:1

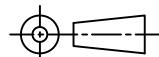

RoHS compliant

REV.	DESCRIPTION	DATE
A	New Drawing	2022/05/30

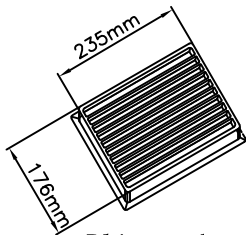

Blister box cover

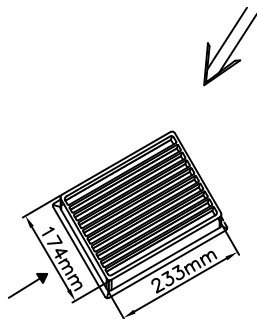

Blister box bottom

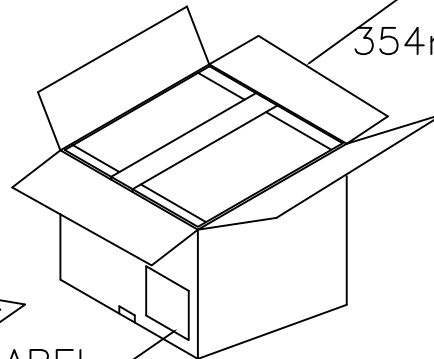

BOX DIMENSIONS:
354mm X 354mm X 330mm

RoHS compliant

Packing instructions

PIN NO.	Each box (PCS)	Each case (PCS)
2*3Pin	520pcs	18720pcs
2*4Pin	400pcs	14400pcs
2*5Pin	320pcs	11520pcs
2*10Pin	160pcs	5760pcs

19 PCS Vacuum disc

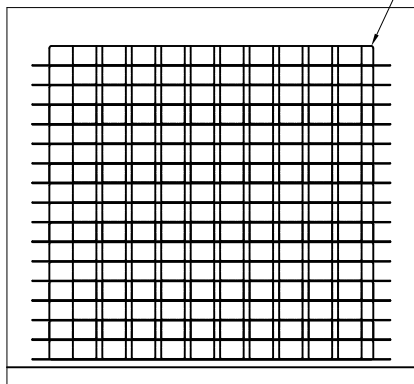

finished product

Superior Tech Co., Ltd.

General Tolerance

X. ± 0.5	DRAWN Tom
.X ± 0.3	
.XX ± 0.2	CHECK
.XXX ± 0.1	
Angle	± 5°

TITLE

FHMD-DAXXXG1NBON-B_Packing

DRAWN

Tom

DATE

2022/05/30

NO.

002

CHECK

DATE

PART NO.

FHMD-DAXXXG1NBON-B

APPROVED

DATE

CUSTOMER NO.

DK

REV.

A

UNIT

mm

SCALE

1:10

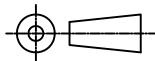

(Q2-R03-01A) ST-R05-07